

# HEAT GENERATION CONCERNS ASSOCIATED WITH EXTREME FAST CHARGING

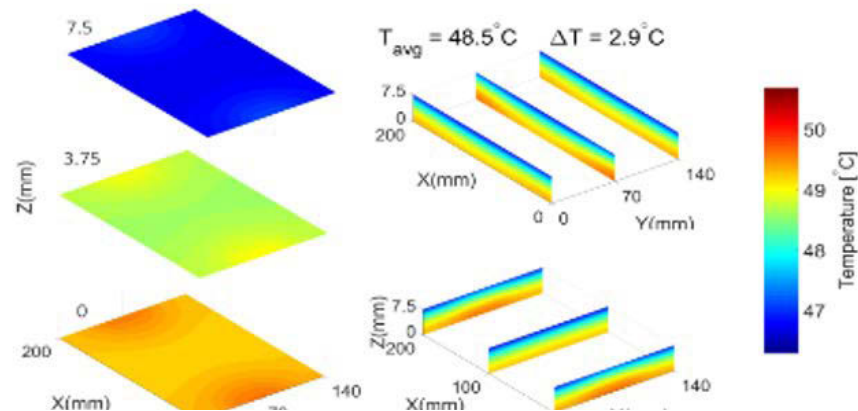

**MATTHEW KEYSER**  
National Renewable Energy  
Laboratory (NREL)

#### CO-AUTHORS:

- **NREL:** Andrew Colclasure, Josh Major, Kae Fink, Weijie Mai, Shriram Santhanagopalan
- **INL:** Eric Dufek
- **LBL:** Sean Lubner, Ravi Prasher, Eric McShane, Steve Harris
- **Stanford:** Jiayu Wan, Wenxiao Huang, Yi Cui
- **SLAC:** Mike Toney

# OVERVIEW

## Timeline

- Start: October 1, 2017
- End: September 30, 2021
- Percent Complete: 75%

## Budget

- Funding for FY20 – \$5.6M

## Barriers

- Cell degradation during fast charge
- Low energy density and high cost of fast charge cells
- Low energy efficiency associated with high specific energy density cells – advanced chemistries

## Partners

- Argonne National Laboratory (ANL)
- Idaho National Laboratory (INL)
- Lawrence Berkeley National Lab (LBNL)
- National Renewable Energy Laboratory (NREL)
- SLAC National Accelerator Lab
- Oak Ridge National Lab (ORNL)

# RELEVANCE – BATTERY THERMAL IMPLICATIONS

Life, cost, performance, and safety of energy storage systems are strongly impacted by **temperature**.

## Objectives of Heat Generation Thrust:

- Provide feedback to DOE on the battery thermal challenges associated with XFC
- Understand temperature nonuniformity within cell during XFC
- Develop techniques for operando interior temperature measurements
- Identify limitations of using high specific energy density cells
- Identify thermal areas of concern with existing battery systems
- Identify how changes to the battery chemistry and cell design affect the cells' **efficiency** and **performance**
- Identify state-of-the-art thermal management strategies and how these can be applied to future battery electric vehicles

# FY 2020 MILESTONES

Milestone	Due Date	Status
Define the critical parameters that affect heat generation within a cell.	12/31/19	Completed
Quantify heat generation of graphite/Nickel-Manganese-Cobalt (NMC) 532 through calorimeter experiments.	3/31/20	Completed
Develop and evaluate techniques capable of measuring the localized heat generation.	9/30/20	On-track
Develop 3D model capable of assessing heterogeneities, heat transport, and strategies to mitigate temperature rise under XFC conditions.	9/30/20	On-track

# APPROACH – MEASURING HEAT GENERATION AND THERMAL TRANSPORT PROPERTIES FOR MODEL DEVELOPMENT

Identify Critical Parameters that affect heat generation in an electric vehicle (EV) cell.

Microcalorimeter: Heat Generation

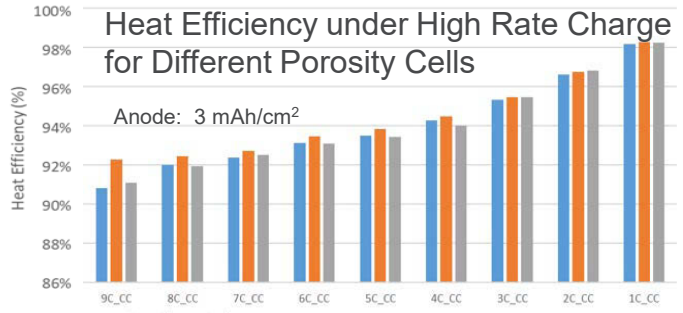

## 1D/3D Model Development

100 kWh Pack Under 6C Constant Current Constant Voltage (CCCV) Charge

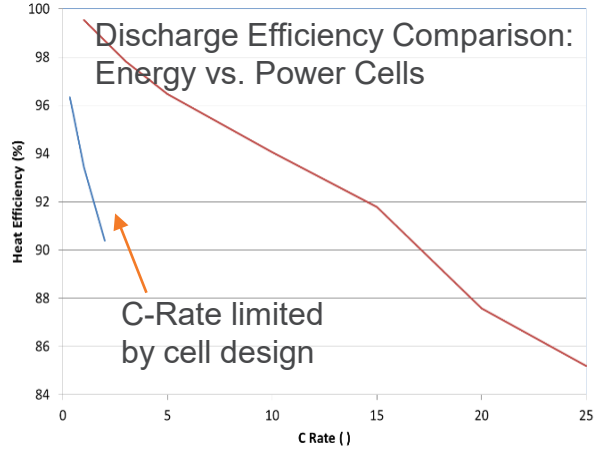
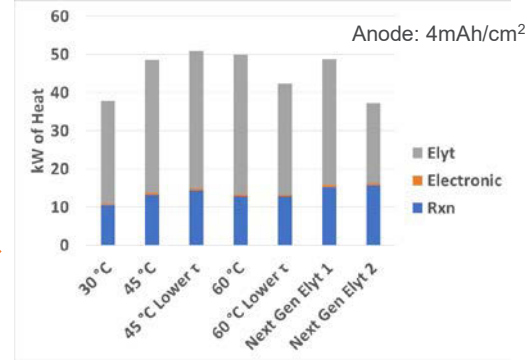

C-Rate limited by cell design

— Energy Cell — HEV Power Cell

HEV: hybrid electric vehicle

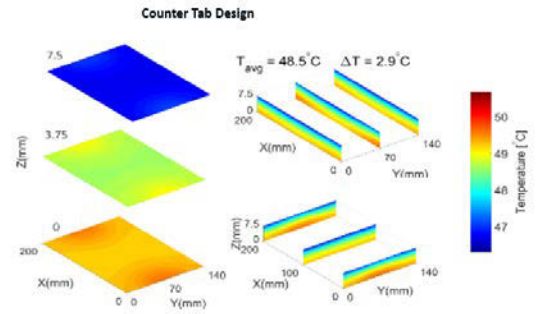

Sensor for spatially resolved heat transport properties.

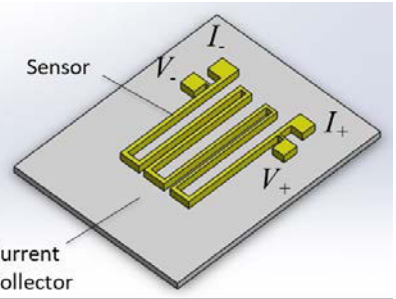

# APPROACH: MEASURE AND UNDERSTAND TEMPERATURE VARIATION WITHIN EV CELL

**Benefit:** Temperature inhomogeneity is often hypothesized to be a culprit in observed inhomogeneous degradation (such as local Li plating, local SOC variation, local solid electrolyte interphase (SEI) thickness variation). Measuring internal temperature will allow for correlation between hot spots to evidence of degradation.

Resistance temperature detector (RTD)  
**stable** in electrolyte and under cycling

**RTD Outer Surface**

**NMC532/Gr**  
200 mAh

**RTD inside**

**Jelly Roll**

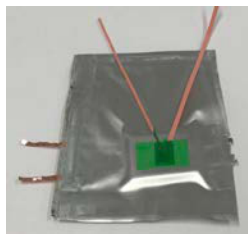

2C Charge

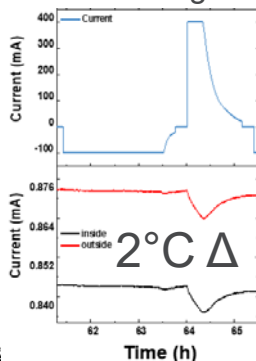

Use X-ray diffraction (XRD)/synchrotron to measure operando temperature gradients via the change in d-spacing of materials in the battery while it is cycling.



**Above:** Battery assembly with plastic block holder compressing clear pouch cell and AZ31 Mg alloy sheet, whose shift in d-spacing was used for pouch surface temperature measurement

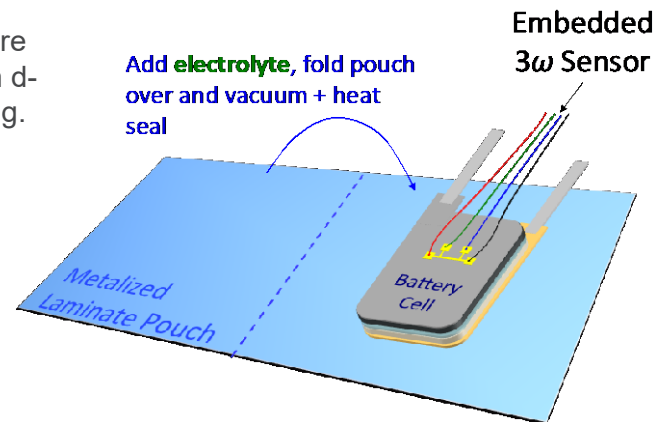

Sweep heating frequency to measure thermal transport properties at different distances from sensor. Used to assess internal temperatures.

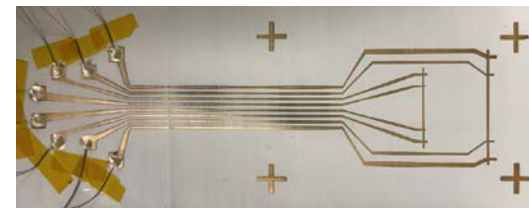

Prototype of exterior 3 $\omega$  sensor.

# OUTLINE

- Understanding heat generation and identifying key parameters that affect heat generation with high energy density cells.
- Operando temperature measurements using an internal RTD.
- Understanding temperature uniformity/nonuniformity through XRD/synchrotron experiments.
- Developing internal/external  $3\omega$  sensor to measure thermal transport properties within cell during cycling.

# MEASURE HEAT GENERATION WITH A HIGH LOADING EV CELL

Measure graphite/NMC532 efficiency (Heat Generation) for medium porosity (36.4%) cell at three temperatures. Data used in 1-D model to identify critical heat generation parameters.

## Anode: LN3107 -190-4A

91.83 wt% Superior Graphite SLC1506T  
 2 wt% Timcal C45 carbon  
 6 wt% Kureha 9300 PVDF Binder  
 0.17 wt% Oxalic Acid

Lot#: 573-824, received 03/11/2016  
 Single-sided coating, CFF-B36 anode

Cu Foil Thickness: 10 μm  
 Total Electrode Thickness: 80 μm  
 Total Coating Thickness: 70 μm  
 Porosity: 34.5 %  
 Total SS Coating Loading: 9.94 mg/cm<sup>2</sup>  
 Total SS Coating Density: 1.42 g/cm<sup>3</sup>

Made by CAMP Facility

## Cathode: LN3107 -189-3

90 wt% Toda NMC532  
 5 wt% Timcal C45  
 5 wt% Solvay 5130 PVDF

Matched for 4.1V full cell cycling  
 Prod: NCM-04ST, Lot#: 7720301  
 Single-sided coating, CFFB36 cathode

Al Foil Thickness 20 μm  
 Al Foil Loading: 5.39 mg/cm<sup>2</sup>  
 Total Electrode Thickness: 91 μm  
 Coating Thickness: 7 μm  
 Porosity: 35.4%  
 Total Coating Loading: 18.63 mg/cm<sup>2</sup>  
 Total Coating Density: 2.6 g/cm<sup>3</sup>

Made by CAMP Facility

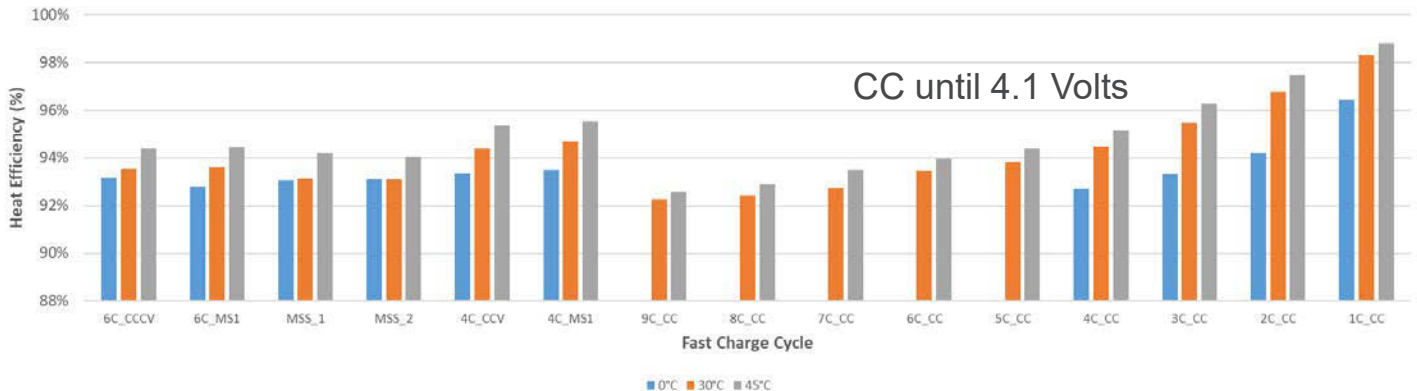

Results at 0°C only valid at low charge rates - 4C and below.

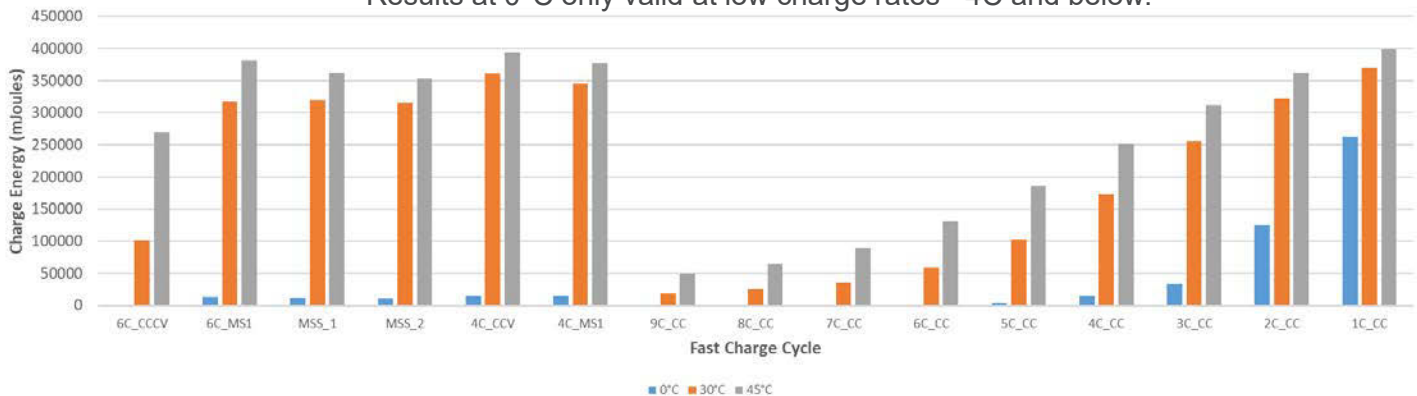



# EFFICIENCY FOR HIGH SINGLE SIDED EV CELLS WITH LOADING OF 4 mAh/cm<sup>2</sup>

1-D model results to identify critical parameters associated with heat generation.

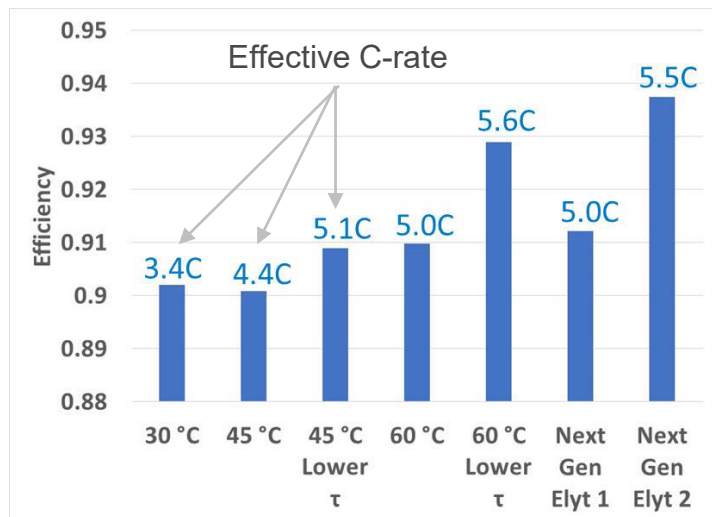

- Minimal gains in efficiency with elevated temperature because effective C-rate increases
- NG1: 1.8X, 3X and increase of 0.05 to ionic conductivity, diffusivity, and transference number
- NG2: 2.3X, 4X, and an increase of 0.15 to ionic conductivity, diffusivity, and transference number

- Efficiency during 10-minute charge of 6 CCCV up to 4.2 V
- Efficiency calculated = Average Heat/Average Power
- Initial temperatures given and cell has  $\leq 8^\circ\text{C}$  rise
- Lower cell overpotential results in significant gains in capacity/effective charge rate

Case Study	State-of-Charge (SOC) Returned
30 °C	57.1 %
45 °C	73.1 %
45 °C – Lower tortuosity ( $\tau$ )	84.8 %
60 °C	84.1 %
60 °C – Lower $\tau$	92.5 %
Next Generation Electrolyte 1	83.5 %
Next Generation Electrolyte 2	91.9 %

# 1-D HEAT ANALYSIS FOR 4 mAh/cm<sup>2</sup> CELLS IN PACK

- 4 mAh/cm<sup>2</sup> anode and scaled to 100 kWh battery for EV (neglecting scaling losses)
- Dominant losses are from electrolyte transport and then charge transfer reactions.
- The 5% carbon black results in negligible losses from electron conduction/contact resistance in cathode (verified by 4-point probe measurements by Dean Wheeler)

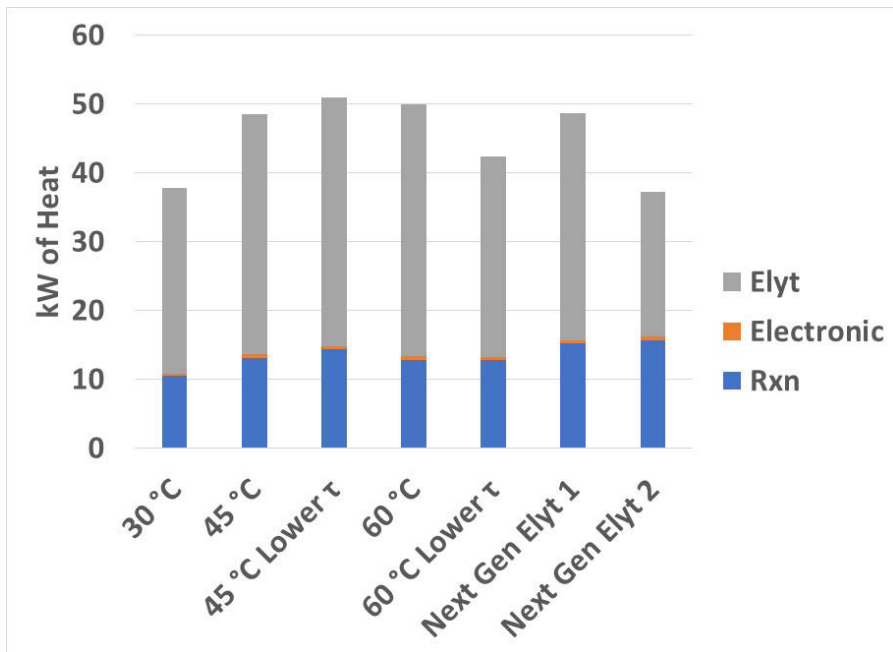

- Each kW of adiabatic heat during 10-minute charge would result in slightly over 1.3°C temperature rise
- For Next Gen 2 electrolyte, 30 kW heat removal during charging would result in 10°C temperature rise
- Requires heat removal much higher than typical heat exchangers in EVs

## LATERAL TEMPERATURE DIFFERENCE ACROSS CELL

- Preliminary analysis for temperature difference across cell
- Each line represents different amount of heat removal from tabs
- 91% efficiency for cell operating with Next Gen 1 electrolyte
- Significant amount of heat is laterally conducted through cathode, anode, and closed cycle (CC) foils

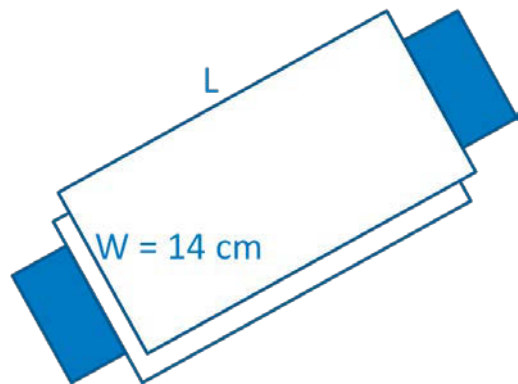

Temperature gain is proportional to length squared

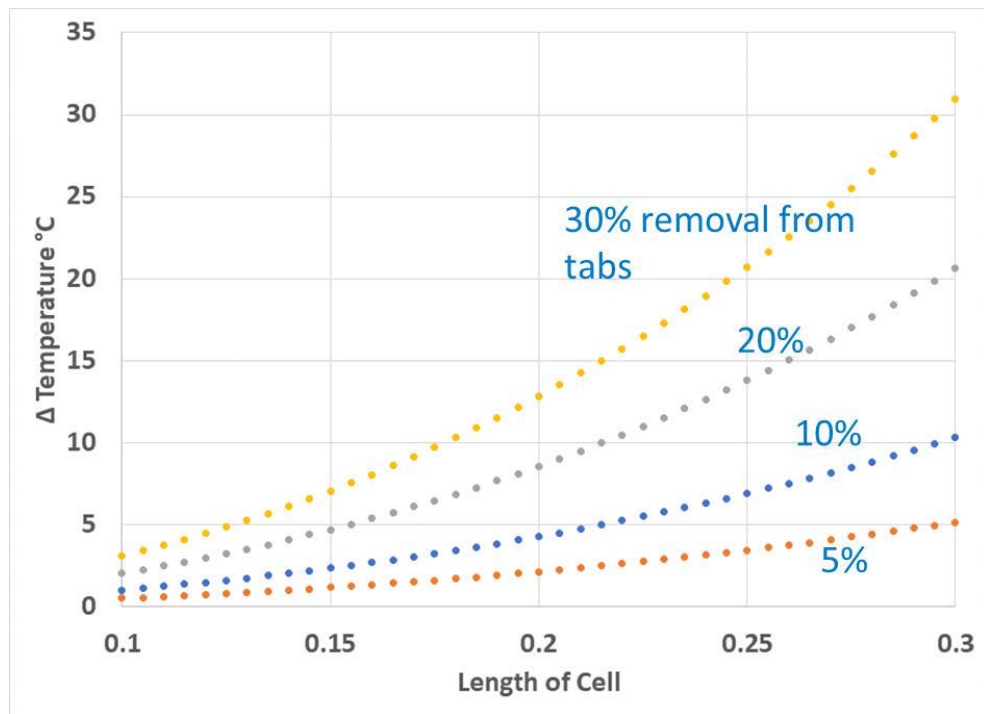

# VERTICAL TEMPERATURE DIFFERENCE ACROSS STACK

- Preliminary analysis for temperature difference across stack/layers
- Analysis assumes 90% of heat leaves through face
- Efficiency = 91%
- Temperature Difference is proportional to (where  $q$  is heat from 1 layer)
  - $dT \propto \sum_1^N q n = \frac{N(N+1)}{2}$  where  $N$  is number of layers

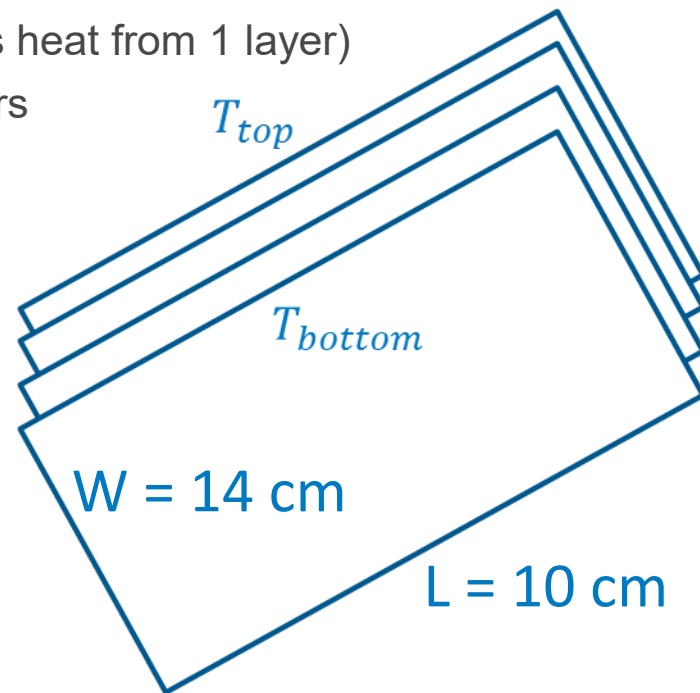
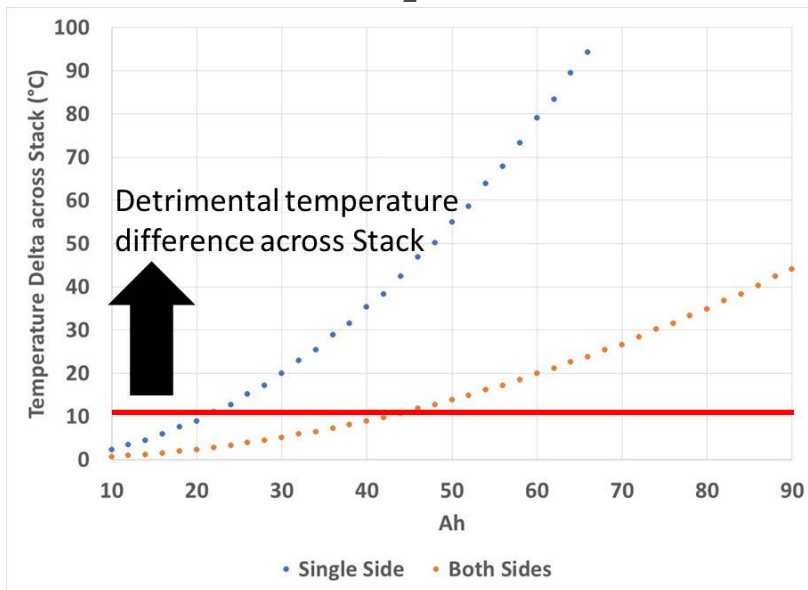

## SUMMARY OF HEAT GENERATION FOR EV LOADING (4 mAh/cm<sup>2</sup>) WITH 10 MINUTE CHARGE

Parameter	Summary/Value
Heat sources	<b>50%-60% electrolyte</b> 20%-30% reaction kinetics 5%-10% lateral CC conduction in large cell
Effective C-rate	3.5C-5.5C (depending on temperature/electrolyte/electrode improvements)
Isothermal heat exchange requirements (100 kWh battery)	40kW-55kW
Adiabatic temperature rise	50°C – 70°C
Voltage drop across cell from CC (L is length between tabs)	Proportional to L <sup>2</sup> (need to limit to 10 cm-15 cm to limit voltage drop below 10 mV)
Temperature difference across single cell (center to tab)	Proportional to L <sup>2</sup> (becomes large if 10% or more heat removed from tabs)
Temperature drop across stack	Proportional to N <sup>2</sup> (number of layers) likely limited to 30 Ah or require cooling on both sides.
Increasing CC foil thickness by a factor of 2	Enables cells 20 cm – 30 cm in length. Reduces cell density from 230 Wh/kg to 210 Wh/kg

# BUILDING WORKING RTD IN ELECTROLYTE

Improving device structure for stability in cell.

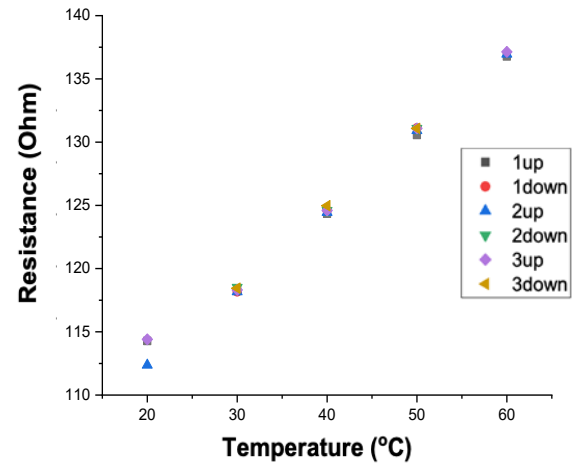
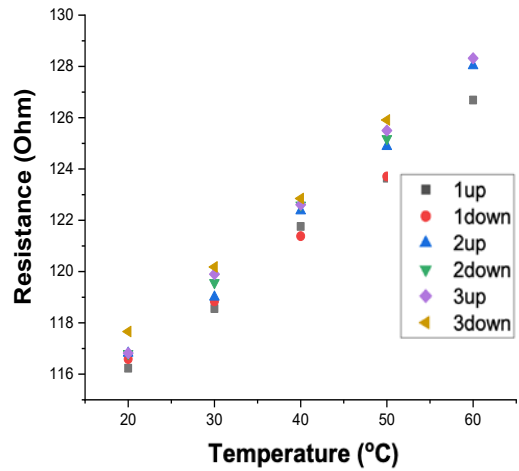
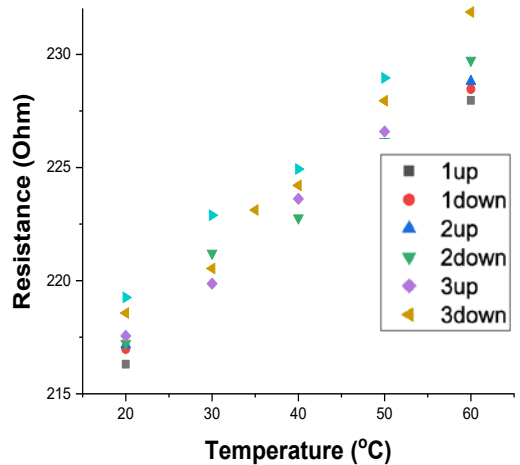
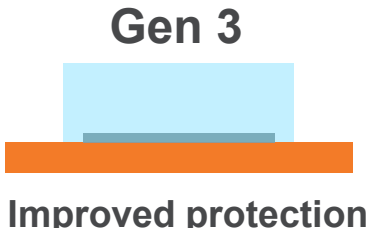
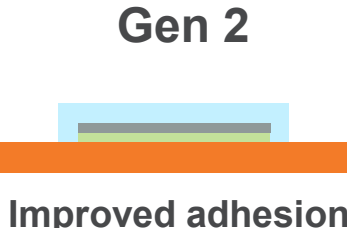
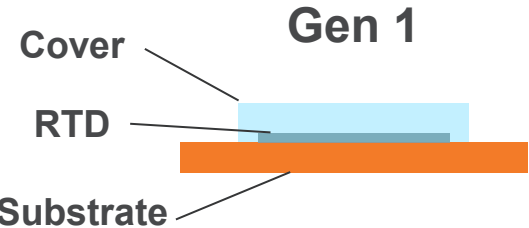

Stable and reliable temperature responses are demonstrated with Gen 3 RTD

# RTD - OPERANDO TEMPERATURE MONITORING

Resistance change observed at different C-rates

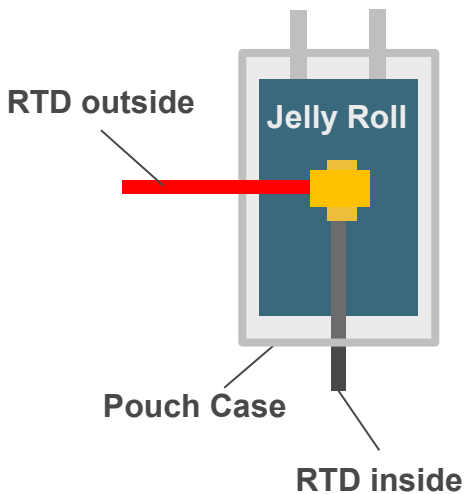

NMC 532/Graphite  
200 mAh

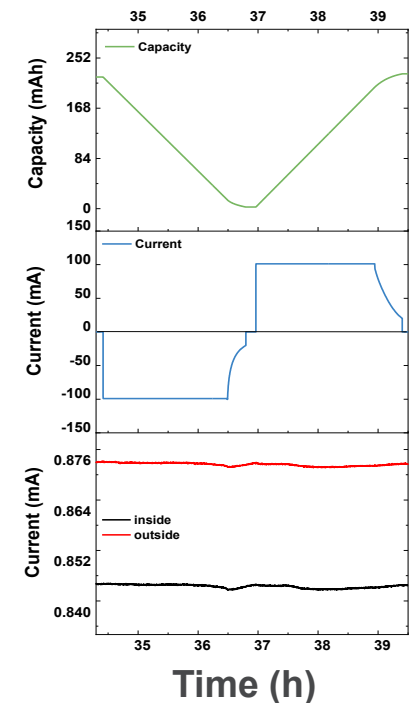

Observable change at 0.5C

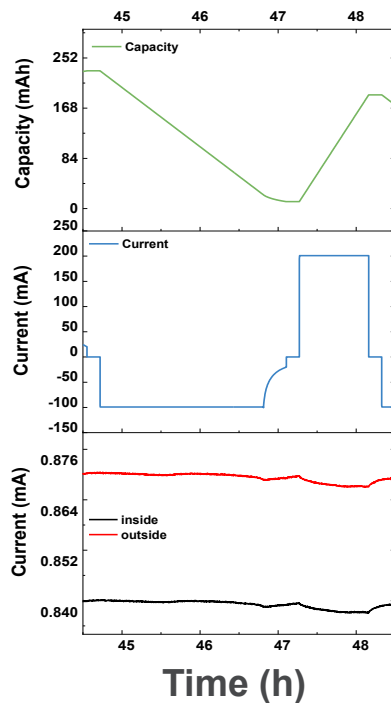

Moderate change, 1C

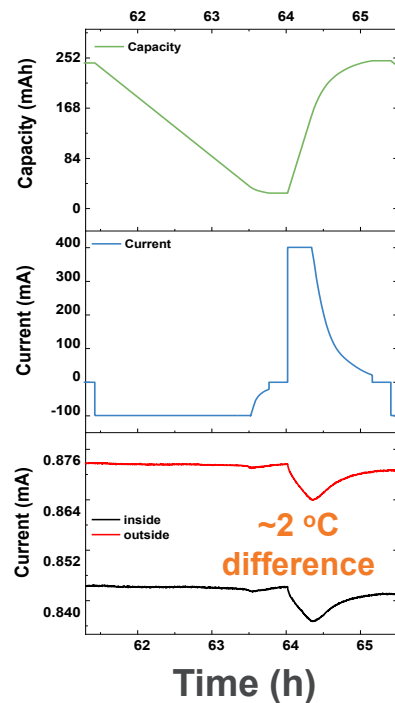

Significant change, 2C

# OPERANDO TEMPERATURE MEASUREMENTS IN POUCH CELLS

XRD/synchrotron experimental setup for single layer pouch cell.

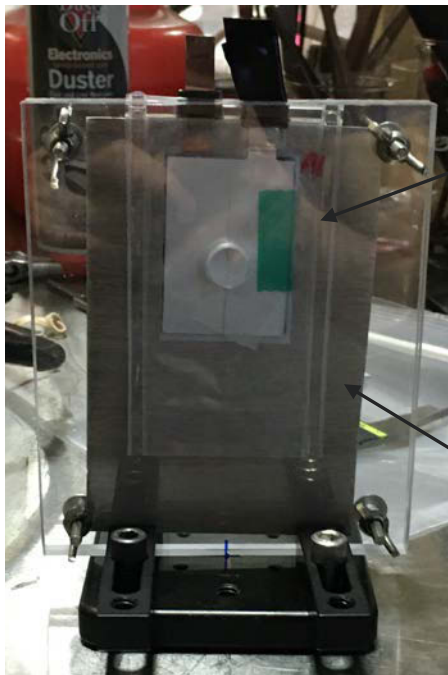

Clear pouch cell  
(standard pouch  
material aluminized,  
obscuring aluminum  
CC peak)

Mg alloy sheet to  
assess pouch  
temperature.

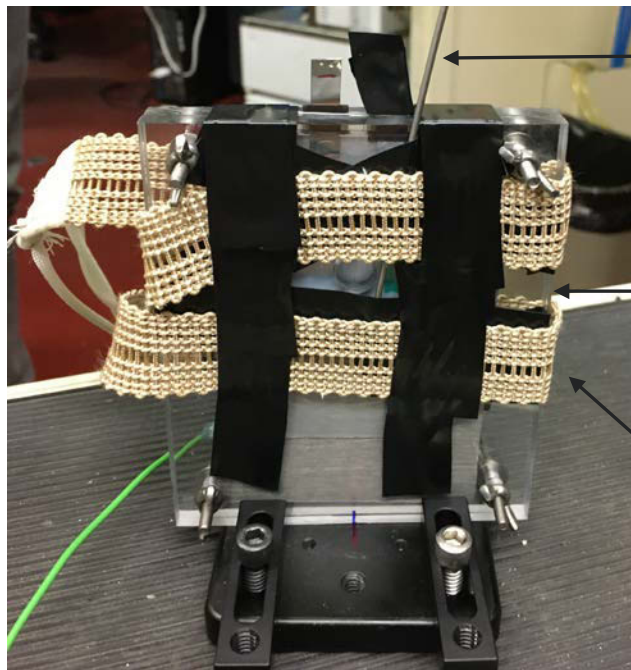

Thermocouple  
(plastic block surf.)

Thermocouple  
inserted between  
plastic blocks (not  
shown)

Heat tape for  
calibration  
experiments



# OPERANDO TEMPERATURE MEASUREMENTS IN POUCH CELLS

Beamtime experiments completed on February 26<sup>th</sup> and 27<sup>th</sup> at Advanced Light Source.

## ■ Control Experiments

- Temperature varied with heat tape (Room Temperature, 25°C, 30°C, 35°C, 40°C) at constant SOC
- Slow C/2 CC cycling (3.0-4.1 V) while pouch held at 30°C

## ■ Fast Cycling Experiments

- 4C CCCV from 3.0-4.1 V
- 8C CCCV from 3.0-4.1 V

- Thermal analysis pending from recent beamtime.

## Representative XRD spectrum

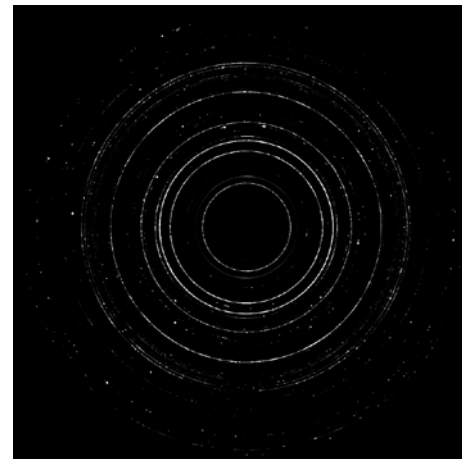

# OPERANDO BATTERY THERMAL TRANSPORT MEASUREMENTS

Developing in-situ  $3\omega$  sensor to quantify thermal impedance changes in cell to quantify internal temperatures.

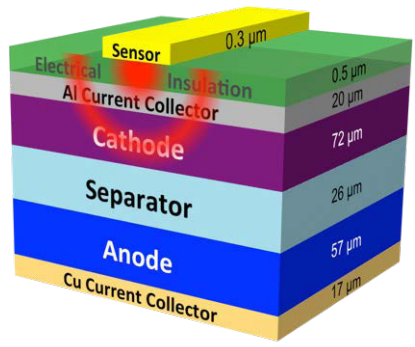
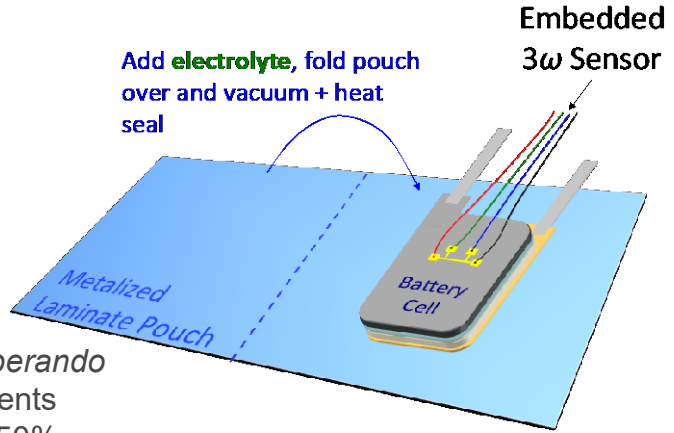

Left: Sweep heating frequency to measure thermal transport properties at different distances from sensor

Used to calculate temperatures within a cell.

Above: Operando measurements revealed ~50% increase of total thermal resistance after over 100 cycles

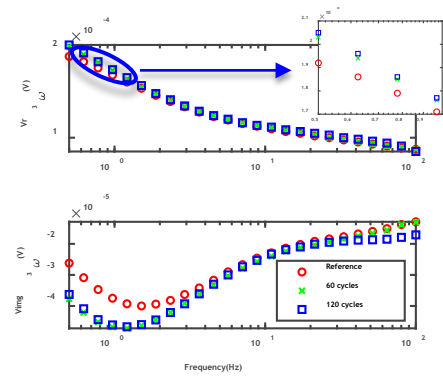
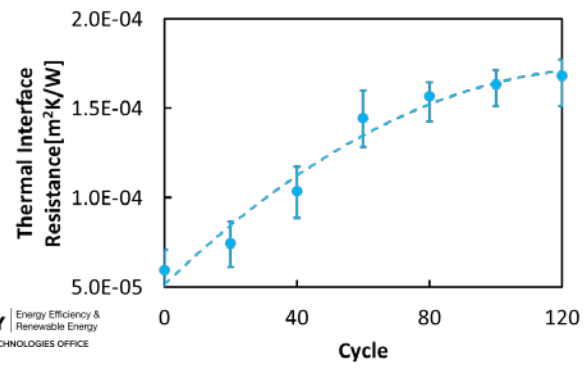

Left:  $3\omega$  sensor raw data shows impedance changes after cycling

# MEASURE EFFECT ON FULL CELL

Quantifying thermal transport changes as the cell ages.

Measure heat flux leaving cell and  $T$ -drop across cell at a 2C charge and 1C discharge rate.

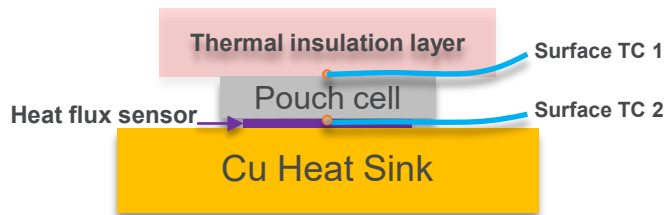

**Below:** Top view of experiment to understand cell impedance changes

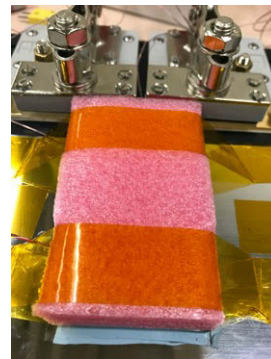

**Future experiments:** vary C-rates,  $T_{\infty}$ , and pressure to understand how these parameters affect impedance changes within cell.

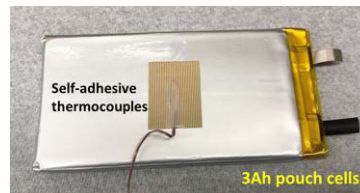

Representative charge + discharge Temperatures

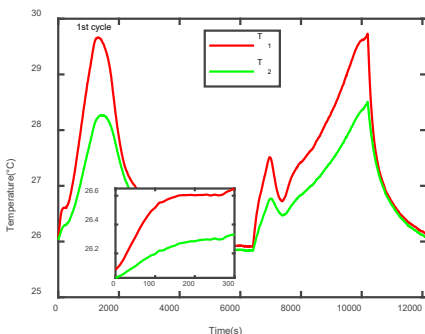

$\Delta T$  vs.  $Q''$  with cycling

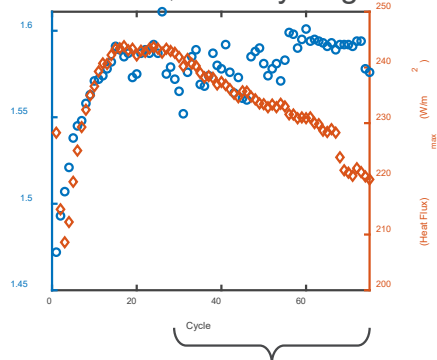

Cell performance with cycling

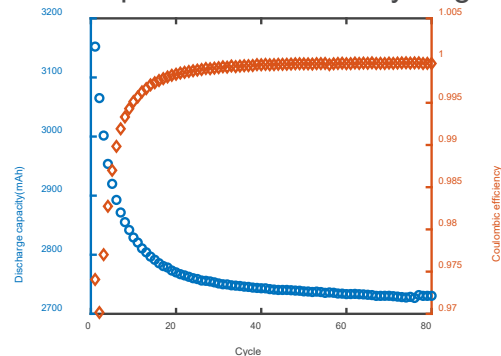

Full cell thermal properties change with cycling

# DIRECT THERMAL RESISTANCE MEASUREMENT OF COMMERCIAL CELLS

Developing an external 3w sensor to simplify use with commercial cells.

Preliminary results: sensors **outside** pouch to directly measure thermal conductivity

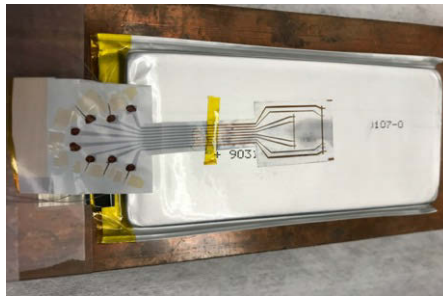
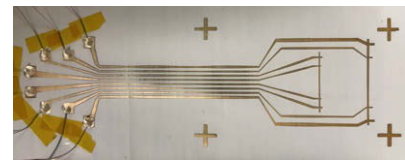
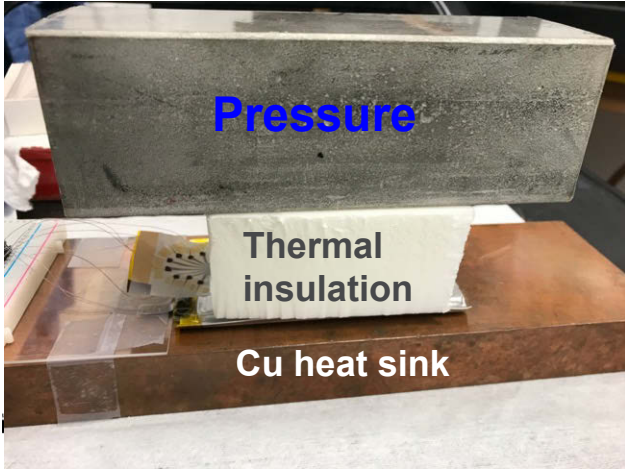
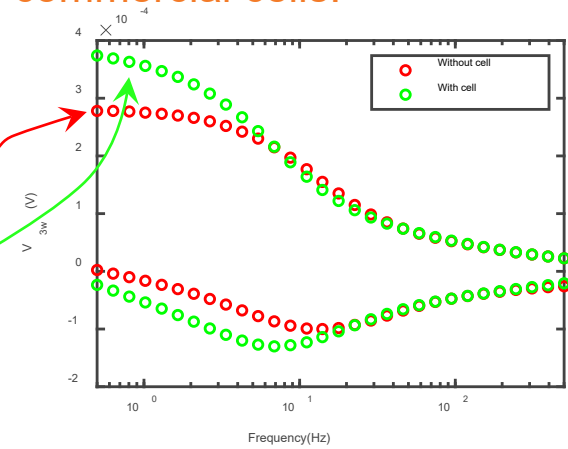
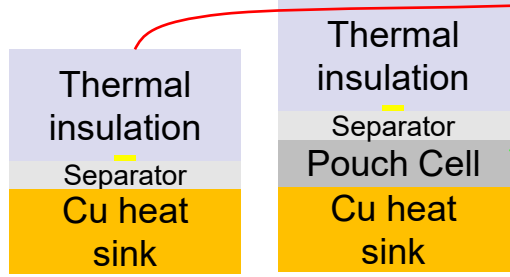

Left: External 3-omega sensor "sticker"

# RESPONSES TO PREVIOUS YEAR'S COMMENTS

Not reviewed during the previous AMR.

# CONTRIBUTORS AND ACKNOWLEDGEMENTS

Abhi Raj  
Alison Dunlop  
Alex Quinn  
Andy Jansen  
Andrew Colclasure  
Antony Vamvakeros  
Anudeep Mallarapu  
Aron Saxon  
Bryan McCloskey  
Bryant Polzin  
Chuntian Cao  
Charles Dickerson  
Daniel Abraham  
Daniel Steingart  
Dave Kim  
David Brown  
David Robertson  
David Wragg  
Dean Wheeler  
Dennis Dees  
Donal Finegan  
Eongyu Yi  
Eric Dufek  
Eric McShane  
Eva Allen  
Francois Usseglio-Viretta  
Guoying Chen  
Hakim Iddir

Hans-Georg Steinrück  
Hansen Wang  
Harry Charalambous  
Ilya Shkrob  
Ira Bloom  
James W. Morrisette  
Jiayu Wan  
Jeffery Allen  
Johanna Nelson Weker  
Josh Major  
John Okasinski  
Juan Garcia  
Kae Fink  
Kandler Smith  
Kamila Wiaderek  
Kevin Gering  
Maha Yusuf  
Marca Doeff  
Marco DiMichiel  
Marco Rodrigues  
Matt Keyser  
Michael Evans  
Michael Toney  
Nancy Dietz Rago  
Ning Gao  
Nitash Balsara  
Orkun Fura  
Partha Mukherjee

Partha Paul  
Parameswara Chinnam  
Paul Shearing  
Pierre Yao  
Quinton Meisner  
Ravi Prasher  
Robert Kostecki  
Ryan Brow  
Sang Cheol Kim  
Sangwook Kim  
Sean Wood  
Seoung-Bum Son  
Shabbir Ahmed  
Sean Lubner  
Shriram Santhanagopalan  
Srikanth Allu  
Steve Trask  
Susan Lopykinski  
Tanvir Tanim  
Uta Ruett  
Venkat Srinivasan  
Victor Maroni  
Vince Battaglia  
Vivek Bharadwaj  
Vivek Thampy  
Volker Schmidt  
Wei Tong  
Weijie Mai

Wenxiao Huang  
William Chueh  
William Huang  
Xin He  
Yang Ren  
Yanying Zhu  
Yi Cui  
Yifen Tsai  
Zachary Konz  
Zhenzhen Yang



*Support for this work from the Vehicle Technologies Office,  
DOE-EERE – Samuel Gillard, Steven Boyd, David Howell*

# REMAINING CHALLENGES AND BARRIERS

## ■ Heat Generation

- Determine methods to reduce the heat produced from electrolyte transport and charge transfer reactions.
- Fast charging at elevated temperatures limits lithium plating and allows for the cell to be charged at higher efficiencies. However, life/degradation, gassing, and delamination concerns will have to be addressed.

## ■ RTD

- Decrease RTD size and improve reliability in electrolyte solvents.
- Determine reliable method to pass electrical feedthroughs into cells.

## ■ XRD/Beamtime

- Incorporate different current collectors into multi-layer cell to understand temperature difference between interior/exterior of cell.

## ■ Thermal Transport Experiments

- Reduce size of internal/external  $3\omega$  sensors.
- Link model with data from  $3\omega$  sensors in multi-layer pouch cells to calculate internal temperatures.

# PROPOSED FUTURE WORK

## ■ Heat Generation

- Use heat generation data and incorporate into 3-D thermal model.
- Understand how tab configuration, length/width of cell, thickness of electrodes affects temperature uniformity within cell.

## ■ RTD

- Continue to optimize RTD size and chemical resistance to electrolyte solvents.
- Incorporate optimized RTD in multi-layer lithium-ion pouch cell.

## ■ XRD/Beamtime

- Analyze results to determine temperature changes between aluminum, copper, and pouch material via the magnesium sheet adhered to outside of cell.

## ■ Thermal Transport Experiments

- Optimize internal/external  $3\omega$  sensors.
- Carrying-out direct temperature rise observation experiments.
- Exploring sensor material options to boost sensitivity.



# SUMMARY

## ■ Heat Generation Critical Factors for an EV Pouch Cell

- 100 kWh battery would produce 50 kW of heat during a 10-minute charge, with significant amount of heat being from li-ion transport/conduction within the electrolyte phase.
- 1 kW of heat generation during a 10-minute charge results in a 1.3°C adiabatic temperature rise.
- If allowable temperature rise is kept to 20°C, then 35 kW of heat must be removed which is substantially more than present-day heat exchangers in electric vehicles.
- If cooling is only available from one face side of cell, then capacity is likely limited to ~30 Ah.
- Cooling both sides of pouch would enable cells up to 50 Ah - 60 Ah.
- Large amounts of heat can be removed via tab cooling. However, the temperature difference between the center and edge of layers becomes large when > 20% of heat is removed through tabs.
- Significant benefit to improving thermal conductivity of anode, cathode, separator, and electrolyte → not much benefit from enhancing electrical conductivity of current collectors.

## ■ Measuring Internal Temperatures

- Successful fabrication and test of an internal RTD within a cell.
- Demonstrated XRD imaging of a single layer pouch cell at the Advanced Light Source.
- Coupled modeling results with data from 3ω sensors to understand the thermal transport properties within a cell.



**eXtreme Fast Charge Cell Evaluation  
of Lithium-ion Batteries**

U.S. DEPARTMENT OF  
**ENERGY**

Energy Efficiency &  
Renewable Energy

**VEHICLE TECHNOLOGIES OFFICE**

**NREL/PR-5400-76738**

This work was authored in part by the National Renewable Energy Laboratory, operated by Alliance for Sustainable Energy, LLC, for the U.S. Department of Energy (DOE) under Contract No. DE-AC36-08GO28308. Funding provided by U.S. Department of Energy Office of Energy Efficiency and Renewable Energy Vehicle Technologies Office. The views expressed in the article do not necessarily represent the views of the DOE or the U.S. Government. The U.S. Government retains and the publisher, by accepting the article for publication, acknowledges that the U.S. Government retains a nonexclusive, paid-up, irrevocable, worldwide license to publish or reproduce the published form of this work, or allow others to do so, for U.S. Government purposes.