

Regional Supply of Hydrogen

Michael Penev, Chad Hunter
National Renewable Energy Laboratory
June 14, 2018

DOE Hydrogen and Fuel Cells Program
2018 Annual Merit Review and Peer Evaluation Meeting

Project ID # SA063

Overview

Timeline	Barriers
<p>Start: October, 2016</p> <p>End: September, 2018*</p> <p>* Annual direction determined by DOE</p>	<p>4.2 Technical Approach: Infrastructure Analysis</p> <p>4.5 A. Future Market Behavior: Scenarios to understand vehicle-fuel interactions</p> <p>4.5 E. Unplanned Studies and Analysis Response to H2USA public-private partnership and infrastructure deployment goals</p>
Budget	Partners
<p>FY18 Planned DOE Funding: \$55K</p> <p>Funds Received to Date: \$180K</p>	<p>External References</p> <ul style="list-style-type: none">• Oil & Gas Journal• H2A• HDSAM <p>Planned Reviewers</p> <ul style="list-style-type: none">• H2USA working group members• California Energy Commission• Academic experts• Fuel Pathways and Integration Tech Team (FPITT)

Regional Supply analysis enables forecast of competitive retail price and availability of fuel

Analysis forecasts near- to long-term hydrogen supply chains

Additional pathways and market competition dynamics are extensions of existing SERA analysis framework

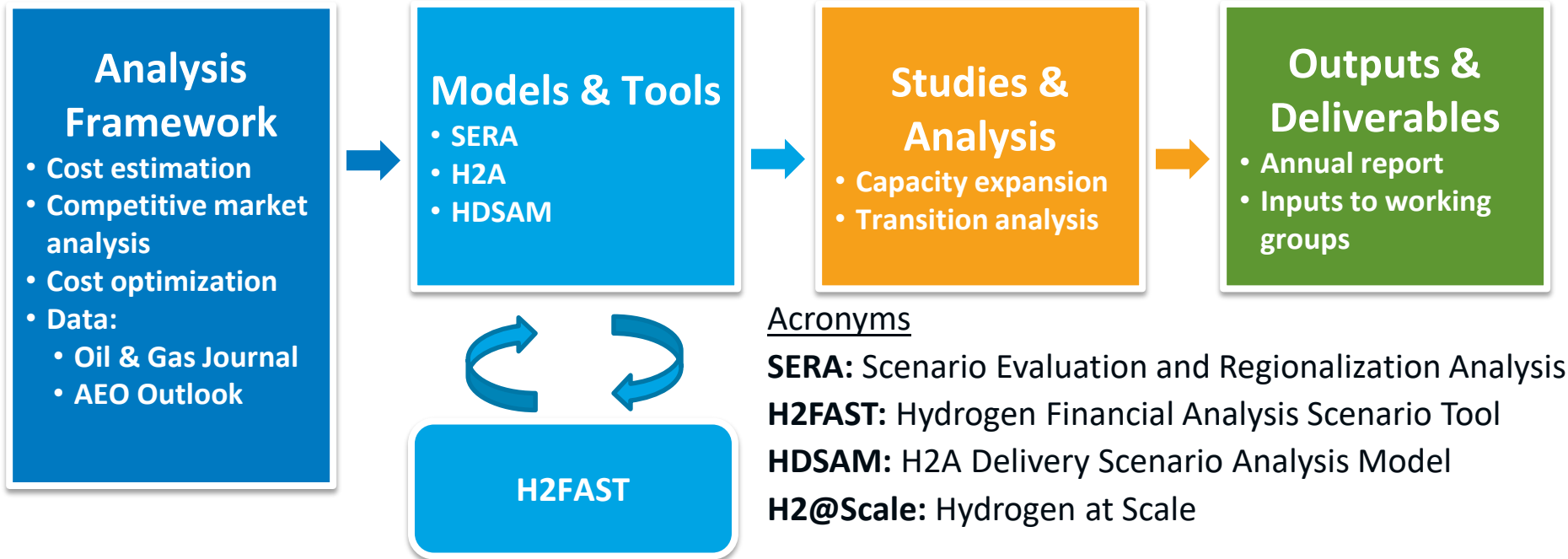

Acronyms

SERA: Scenario Evaluation and Regionalization Analysis

H2FAST: Hydrogen Financial Analysis Scenario Tool

HDSAM: H2A Delivery Scenario Analysis Model

H2@Scale: Hydrogen at Scale

H2@Scale synergy: This light duty vehicle market analysis project helped develop the same modeling tools and analysis framework used by H2@Scale

Analysis of production expansion dynamics forecasts infrastructure equipment and finances

Relevance/Impact 2

Objectives

- Evaluate existing hydrogen production capacity and hypothetical excess capacity
- Forecast production capacity expansion requirements for growing FCEV market demand
- Simulate regional supply chain network dynamics
- Incorporate market competition considerations



Impacts on FCTO barriers during reporting period

- Enhanced analysis of future hydrogen production and retail fueling market behavior (Barrier A)
- Provide timely analytical capabilities to FCTO (Barrier E)

Forecasting incorporates updated and comprehensive supply chain pathways technology competition

Supply-Chain Analysis Using the *SERA* Model

Approach 1

- The *Scenario Evaluation and Regionalization Analysis (SERA)* modeling framework develops optimized hydrogen supply networks in response to FCEV hydrogen demands
- Accounts for the geography of energy resource availability, extraction and conversion costs, transmission and distribution costs, and retail station network costs
- Competes multiple supply-chain technologies to identify least-cost supply options both temporally and spatially

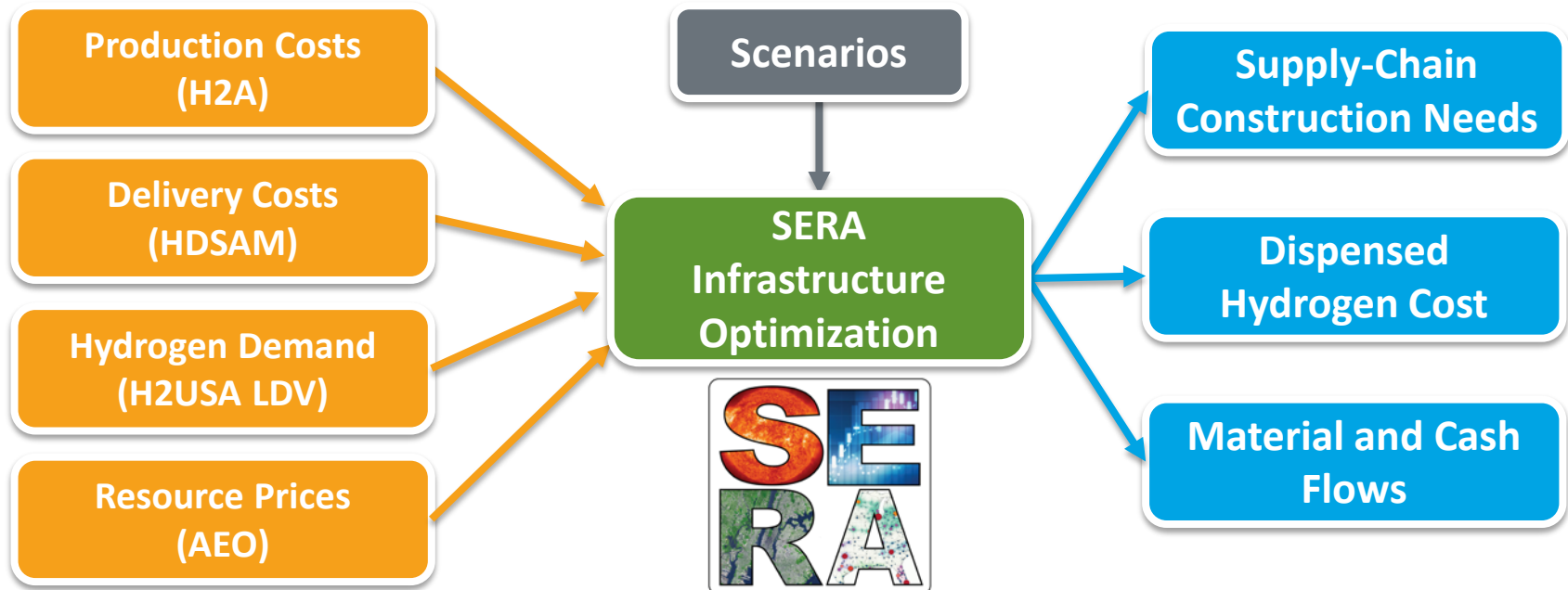

Demand: Light Duty FCEV Hydrogen Demand Based on H2USA Analysis

Approach 2

Market Influence	Urban Markets	State Success	National Expansion
Dominant market drivers	Support at local and municipal levels combined with strong early adopter demand	ZEV mandate and other state market support mechanisms	Combination of strong local, state, and national market support mechanisms
Coordination and planning	Investments focused on most promising metropolitan markets	Strong coordination across ZEV mandate states	Strong coordination and planning across all regions
Consumer adoption	High concentrations of early adopters guide market development	FCEV adoption primarily driven by ZEV mandate	Adoption moves quickly from concentrated early adopters and ZEV mandate states to broad megaregion markets
HRS network expansion	Gradual expansion from promising urban markets to nearby cities	Focus on ZEV mandate states, with gradual expansion into additional markets	Strong stakeholder planning and coordination reduces investment risks, allowing rapid network expansion
FCEV sales per year (millions) and total urban area market share (%) in 2050			
United States	3.1 M (23%)	5.0 M (35%)	8.9 M (59%)
California (CA)	1.0 M (49%)	1.3 M (64%)	1.7 M (84%)
Other ZEV States (ZEV)	0.9 M (26%)	1.9 M (56%)	1.9 M (57%)
Rest of Country (ROC)	1.2 M (10%)	1.9 M (14%)	5.3 M (41%)

Light-duty fuel-cell vehicle hydrogen demand growth based on H2USA National Scenarios Report

Demand: National Light-Duty FCEV Sales For Each H2USA Scenario

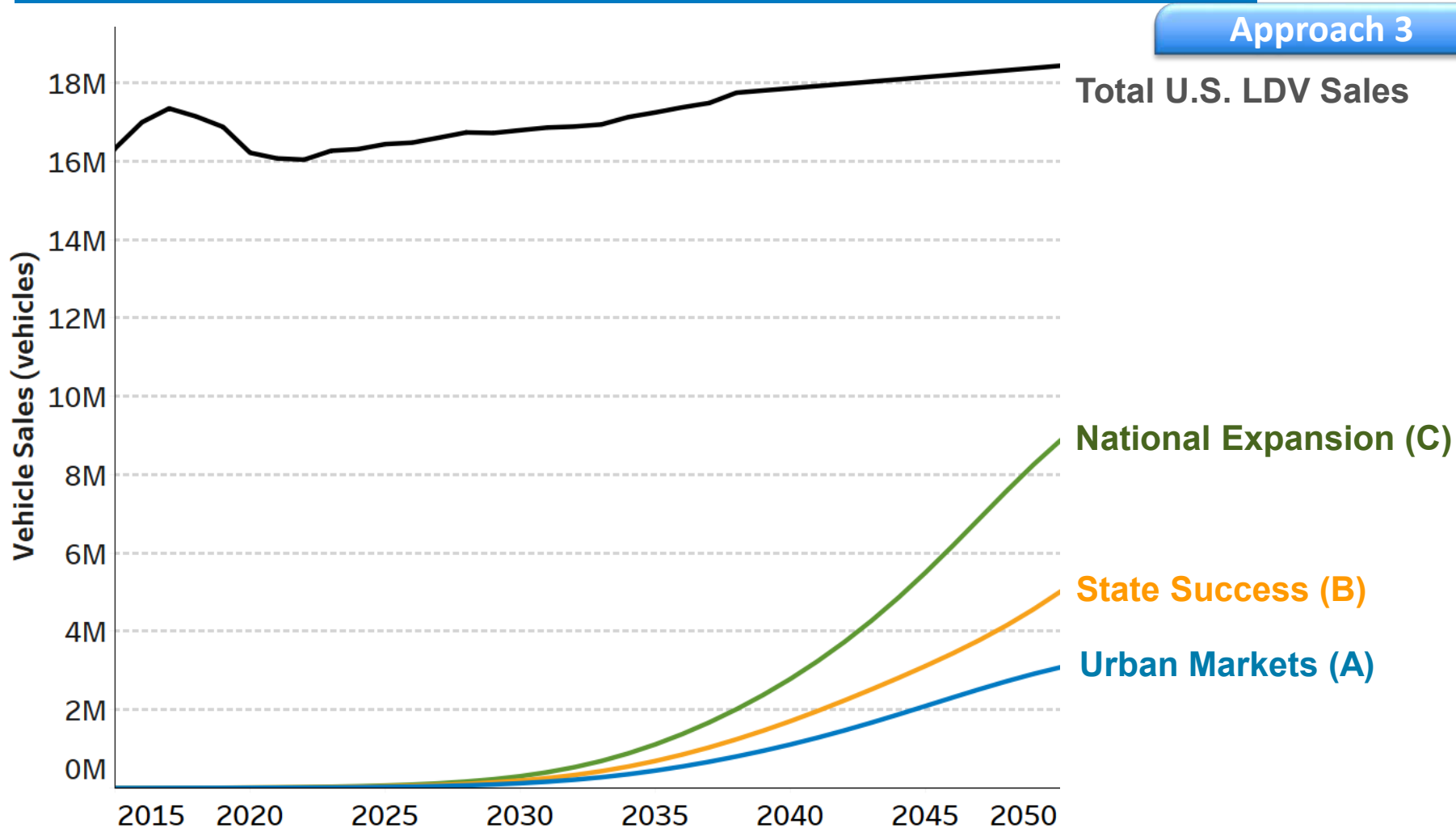

State Success (B) scenario is used as base case scenario

National Hydrogen Scenarios Report:

http://h2usa.org/sites/default/files/H2USA_LRWG_NationalScenarios2017.pdf

Supply: Production (H2A) and Delivery (HDSAM) Technologies Integrated into SERA for Competitive Analysis

Approach 4

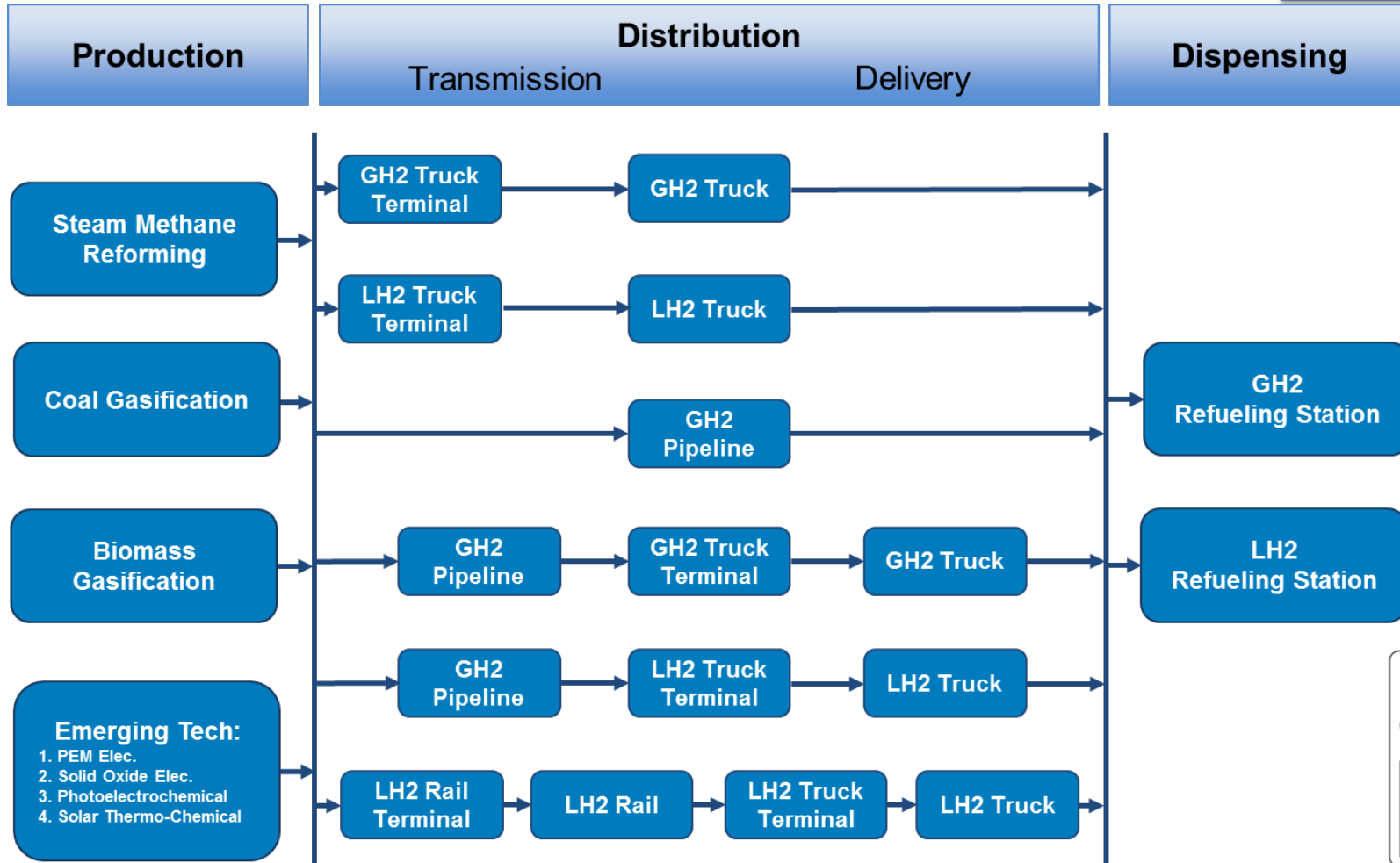

Pathways are competed with geographic consideration of resources availability, prices, and outlook of hydrogen demand growth

Supply: Proposing a New, Hydrogen Delivery Pathway (*H2Grid*) To Compete In SERA

Approach 5

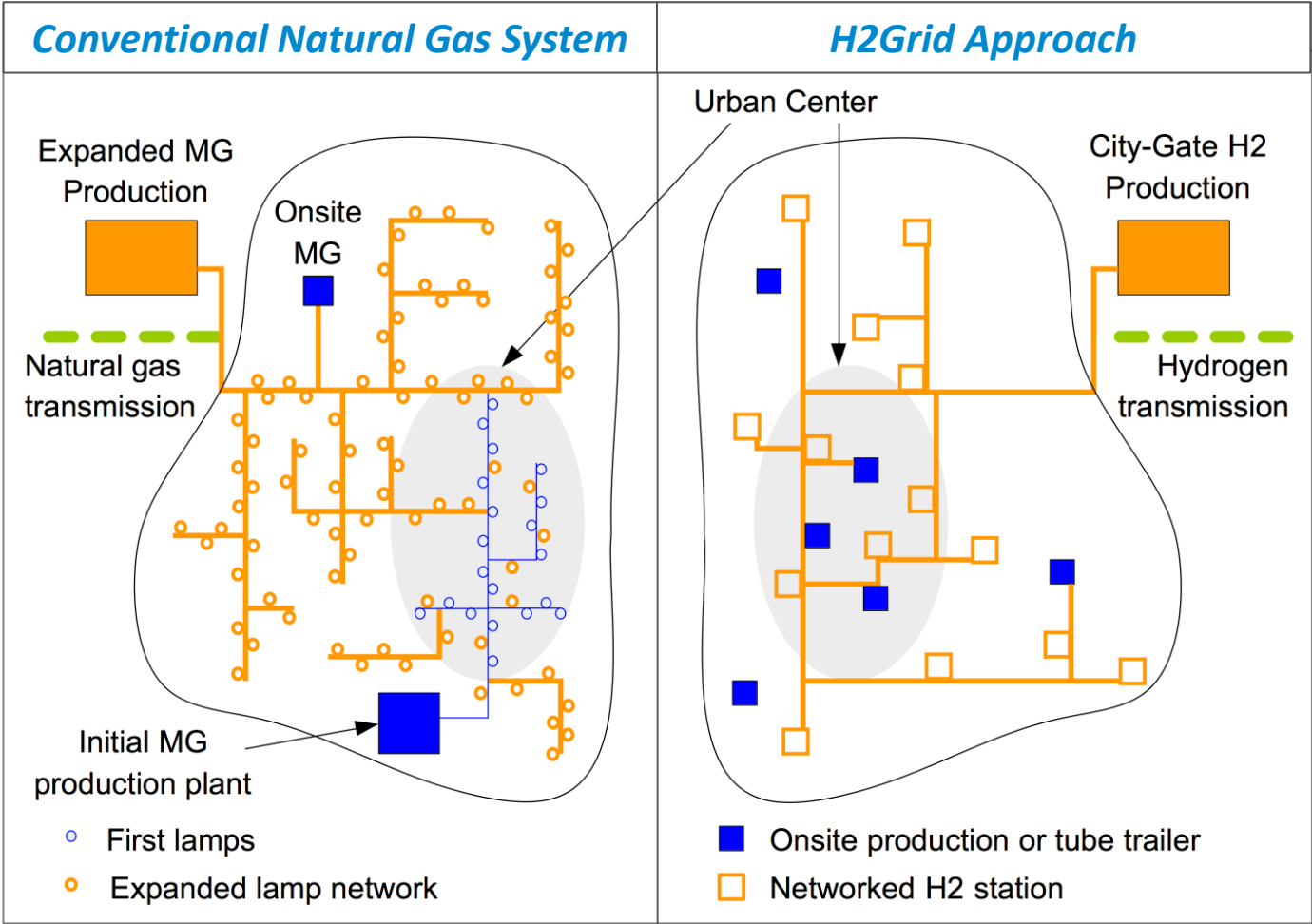

Similar Staged Progression

- Local units
- Distribution network
- Transmission from remote production facilities

Historic precedence: town-gas infrastructure started with local pipeline delivery, followed by external city supply of natural gas delivered above usage pressure

Supply: The *H2Grid* Approach and Benefits

Approach 6

H2Grid Approach:

- Production, storage, and compression in semi-central
- High pressure (1,000 bar) local delivery pipeline
- Interconnected grid of hydrogen pipelines and refueling stations
- Cooling and dispensing at forecourt

H2Grid Benefits:

- **Enhanced retail station adoption:**
 - Lower upfront station cost
 - Reduced station operating complexity
- **Smaller retail footprint:**
 - No on-site storage or compressors (reduced set-back distances)
- **Cheaper compression:**
 - Large, central compressor is much cheaper than many smaller compressors
 - Lower operating cost as larger compressors are more efficient
 - Improved compressor oversight and reliability
- **Improved network reliability:**
 - Interconnected grid and production sites provide mutual redundancy
 - Back-to-back fueling improved due to high-pressure storage in pipes and at production site
 - No reliance on discrete delivery units, traffic issues, offload limits
- **Improved safety**
 - No on-road exposure, truck filling, or off-loading

Existing Hydrogen Production Capacity Compiled and Integrated into SERA Model

Accomplishments 1

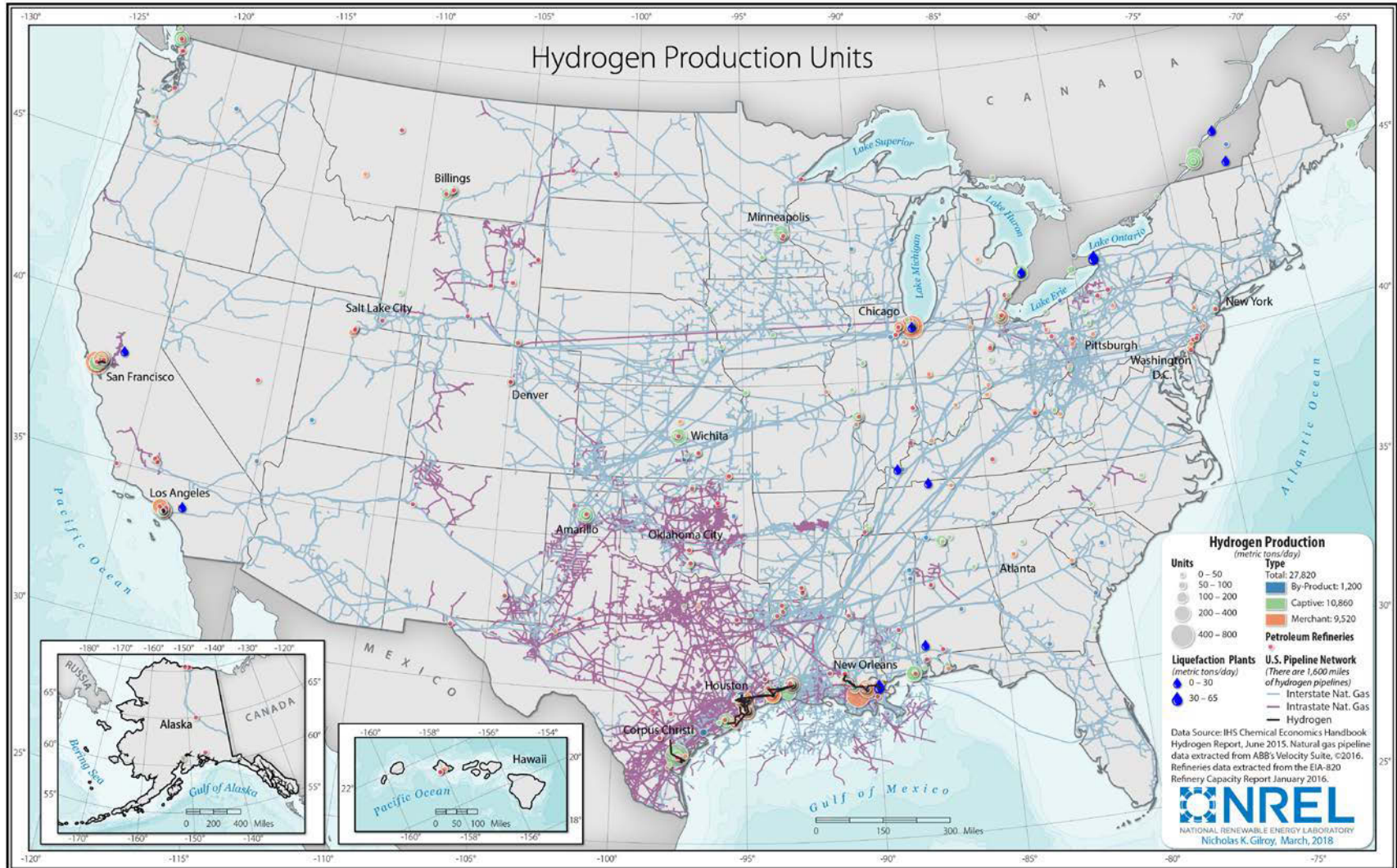

Existing hydrogen production plants were incorporated into SERA

SERA Results: Production Capacity Expansion by 2018 (Scenario B: State Success)

Accomplishments 2

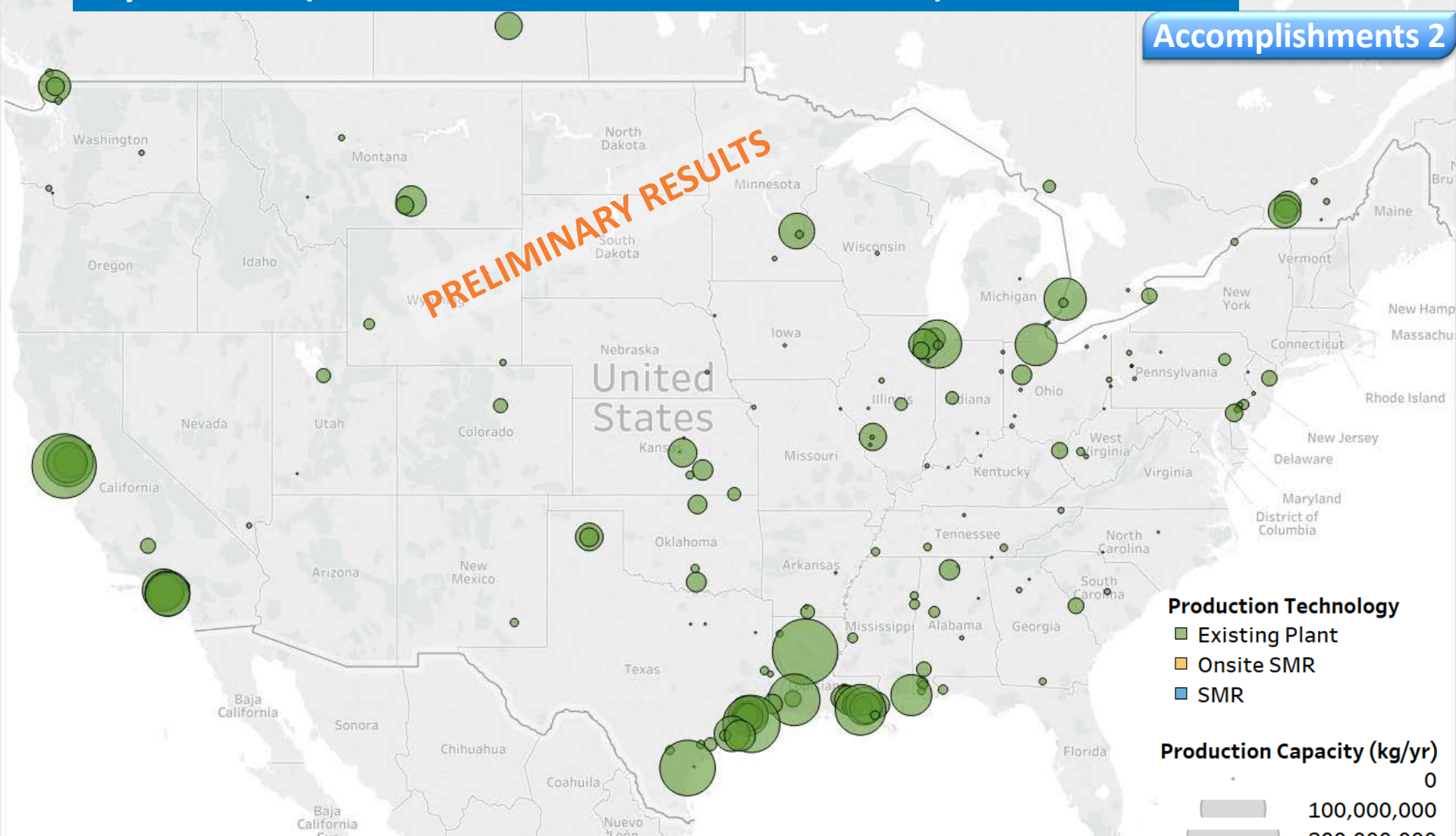

Few new production plants are built by 2018 due to low, localized demand and available supply from existing plants

SERA Results: Production Capacity Expansion by 2021 (Scenario B: State Success)

Accomplishments 3

PRELIMINARY RESULTS

New Plants Built

New Plants Built

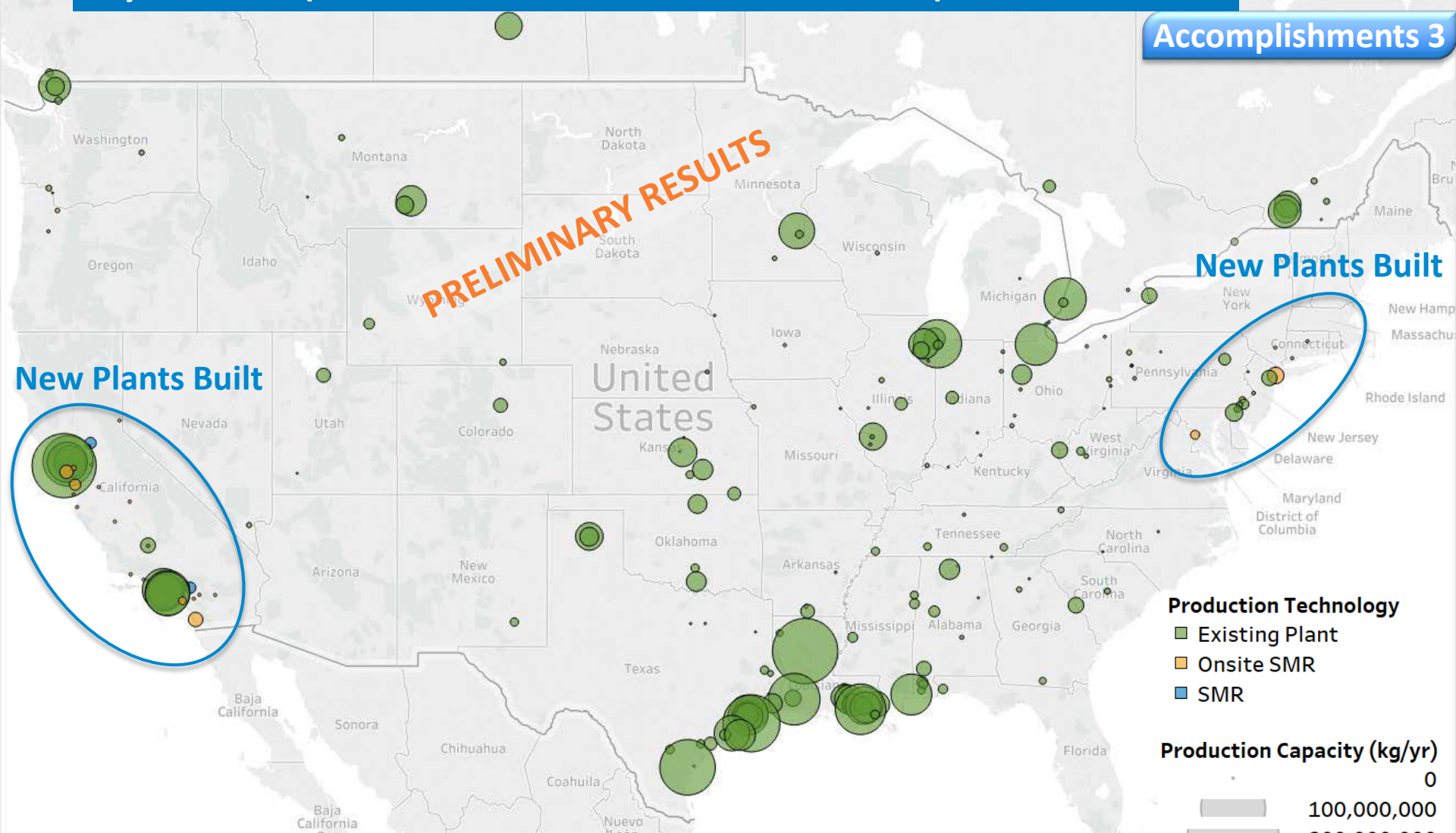

By 2021, production capacity expansion needs are estimated to be in New York, Washington DC, Los Angeles, and Bay Area

SERA Results: Production Capacity Expansion by 2026 (Scenario B: State Success)

Accomplishments 4

New Plants Built

PRELIMINARY RESULTS

Capacity Growth

Capacity Growth

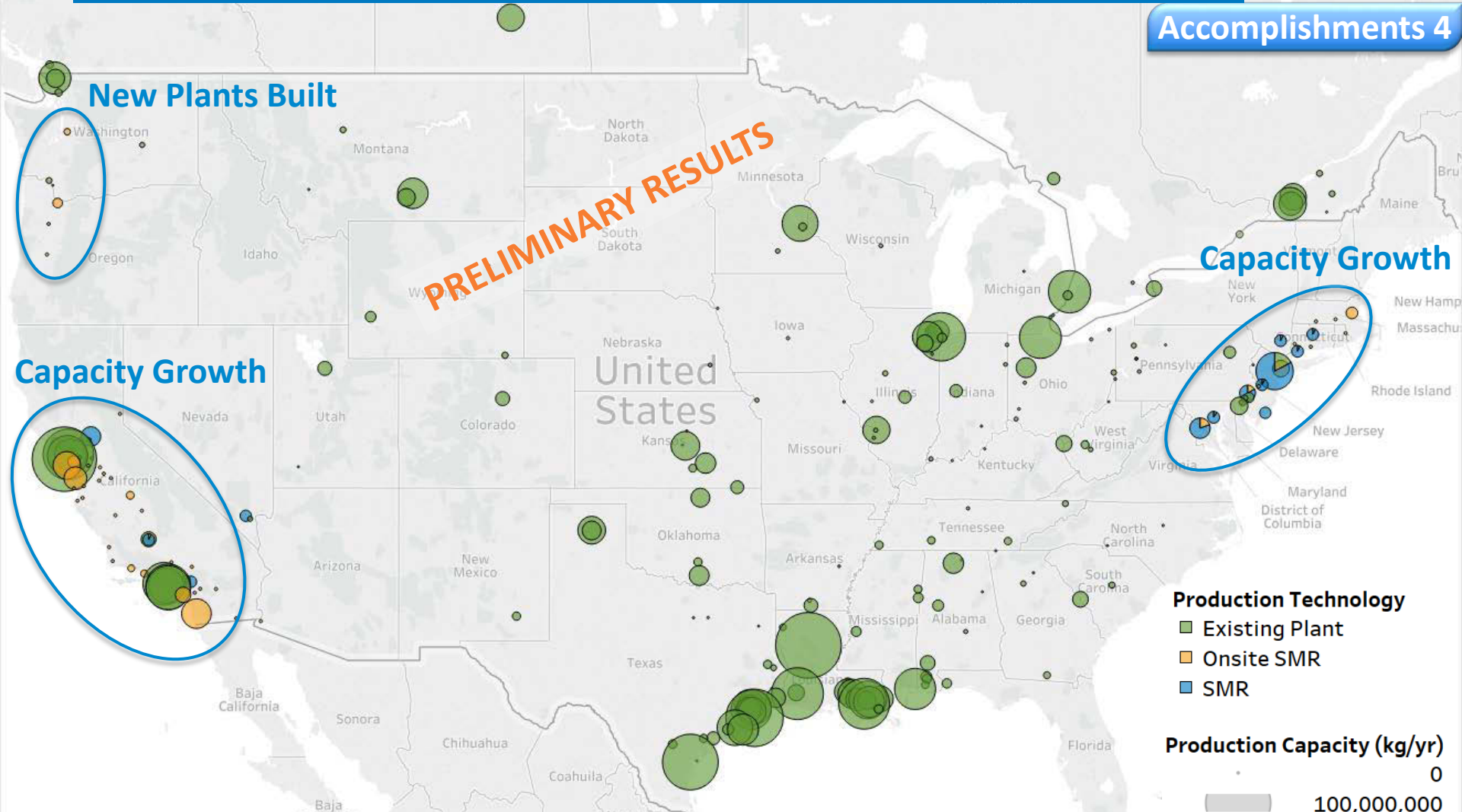

Production Technology

- Existing Plant
- Onsite SMR
- SMR

Production Capacity (kg/yr)

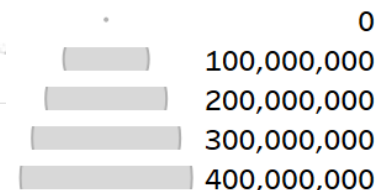

By 2026, second tier of expansion is expected in Seattle, Boston. Capacity growth in CA and North-East continues

SERA Results: Production Capacity Expansion by 2031 (Scenario B: State Success)

Accomplishments 5

PRELIMINARY RESULTS

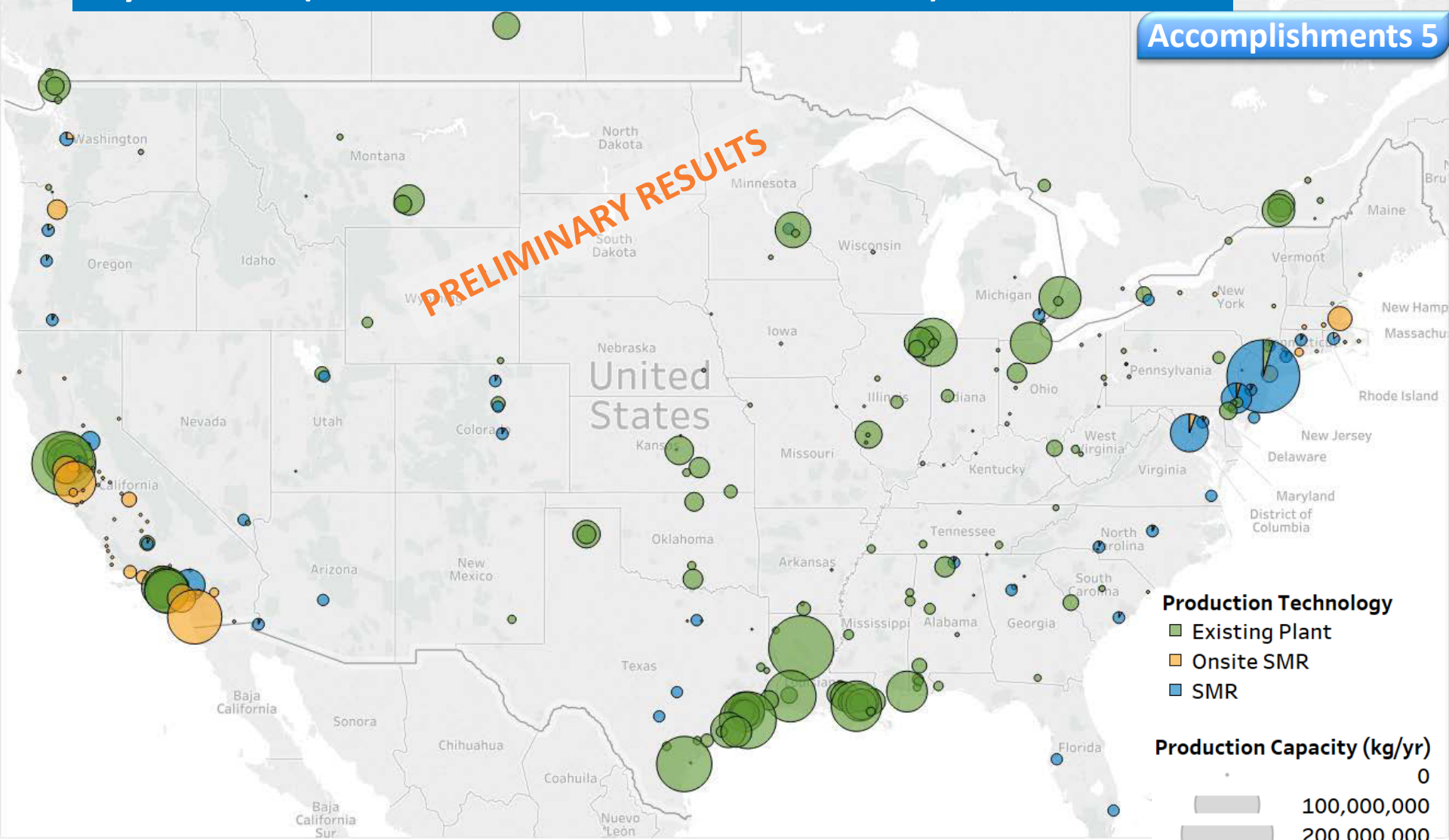

By 2031, inland market growth ramps up in urban areas

SERA Results: Production Capacity Expansion by 2036 (Scenario B: State Success)

Accomplishments 6

PRELIMINARY RESULTS

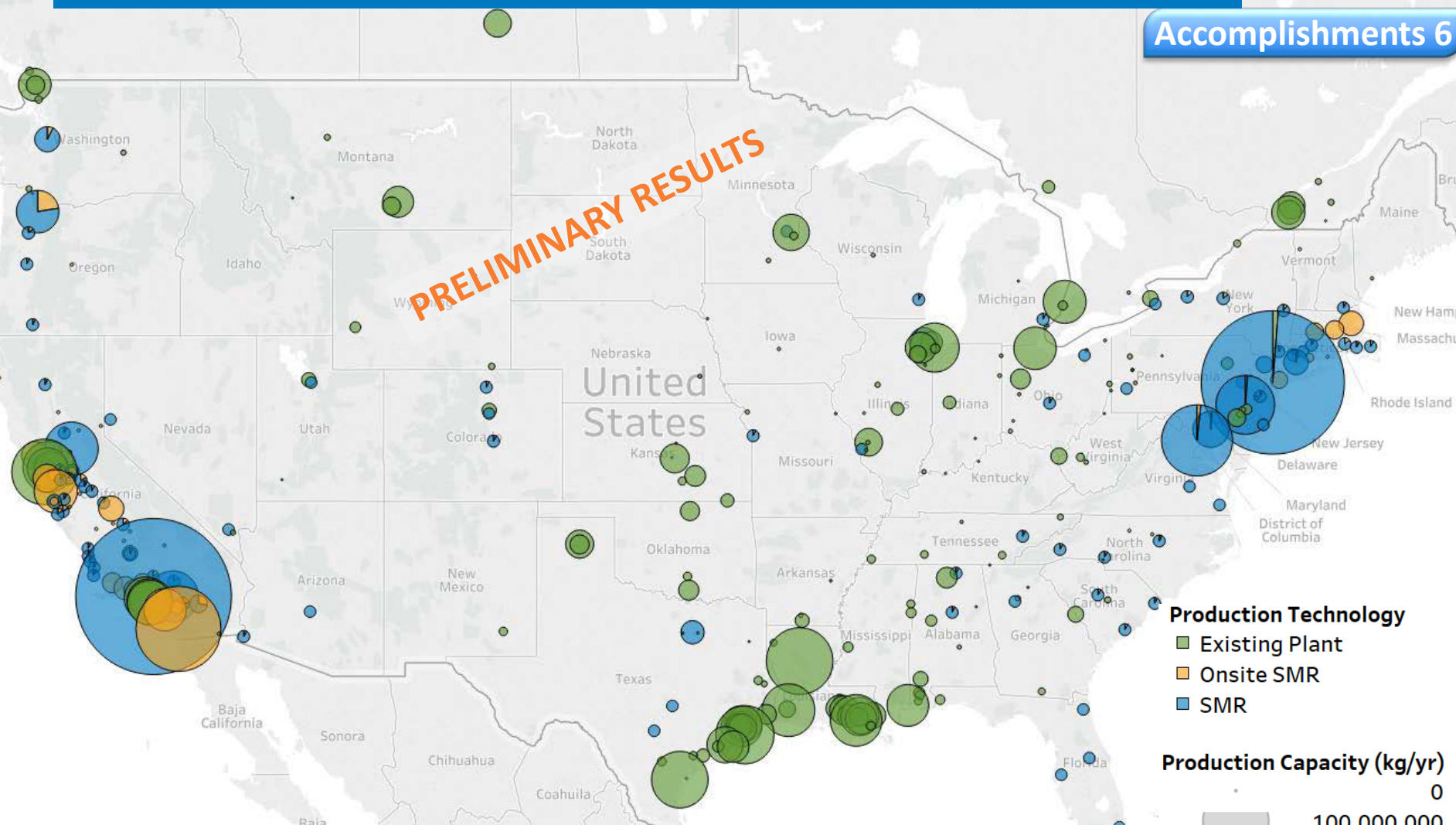

By 2036, hydrogen demand continues to ramp up, large new central SMRs are built in California and Northeast

SERA Results: Production Capacity Expansion by 2040 (Scenario B: State Success)

Accomplishments 7

PRELIMINARY RESULTS

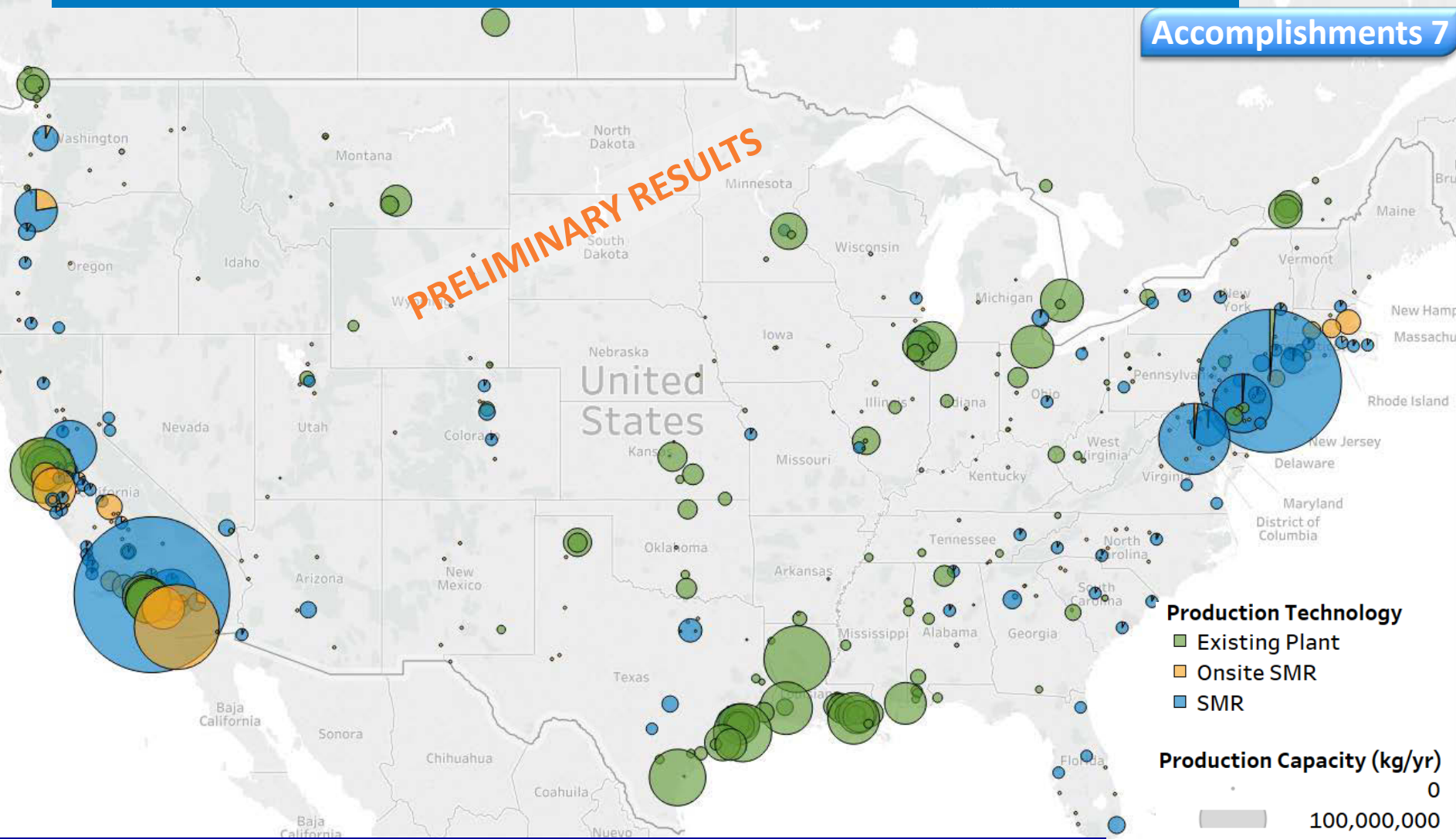

In 2040, smaller urban areas begin to develop hydrogen demand and require small, local production facilities

SERA Results: Incremental Transmission by 2040 (Scenario B: State Success)

Accomplishments 8

PRELIMINARY RESULTS

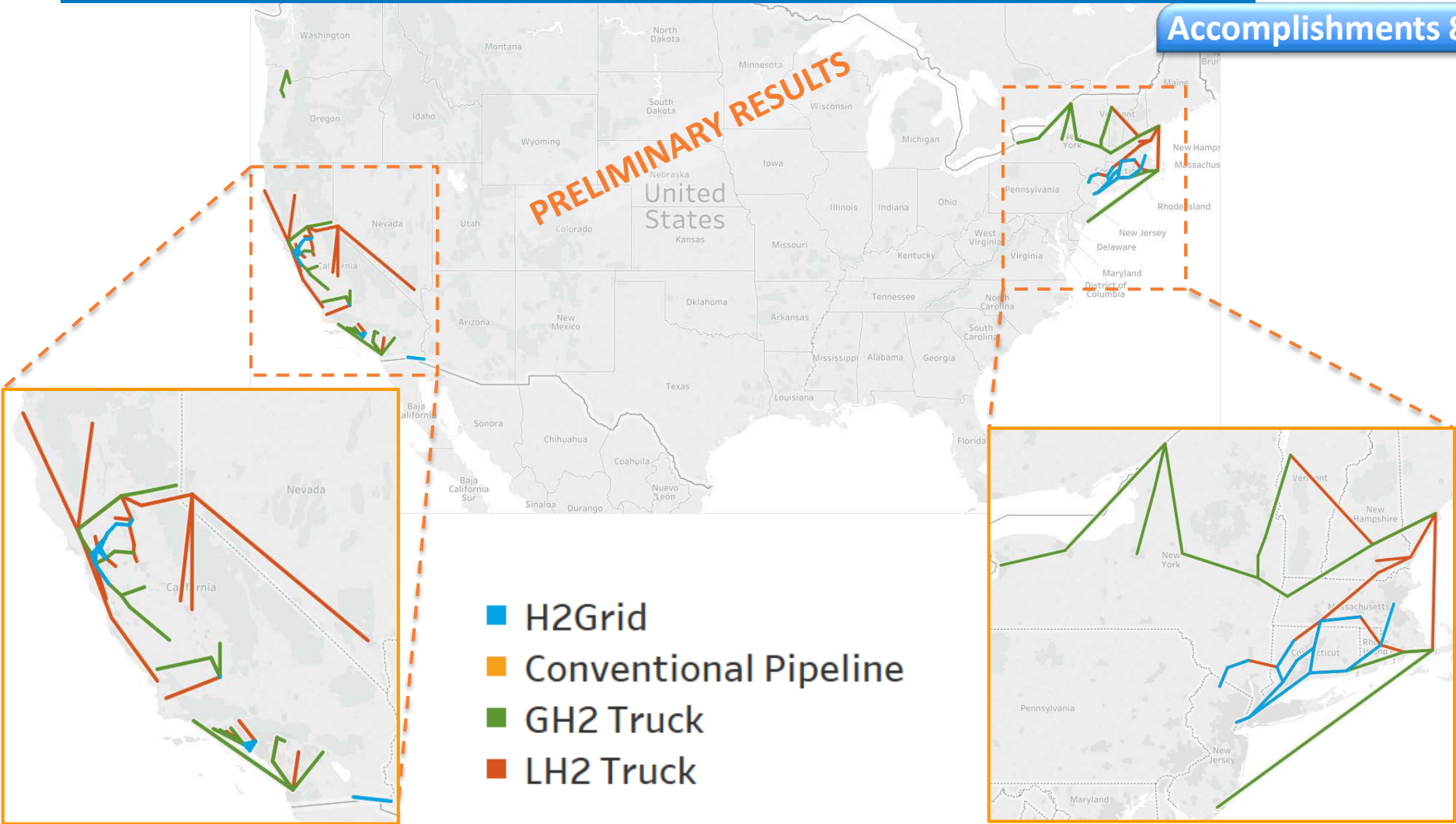

New long distance transmission is sparse due to use of local existing hydrogen supply and high transmission costs

SERA Results: Required Infrastructure Investment By Supply-Chain Segment

Accomplishments 9

Infrastructure investment precedes demand growth trajectory. Capital investment periodicity of 5 years is an artifact of modelling 5-year outlook for investment horizon.

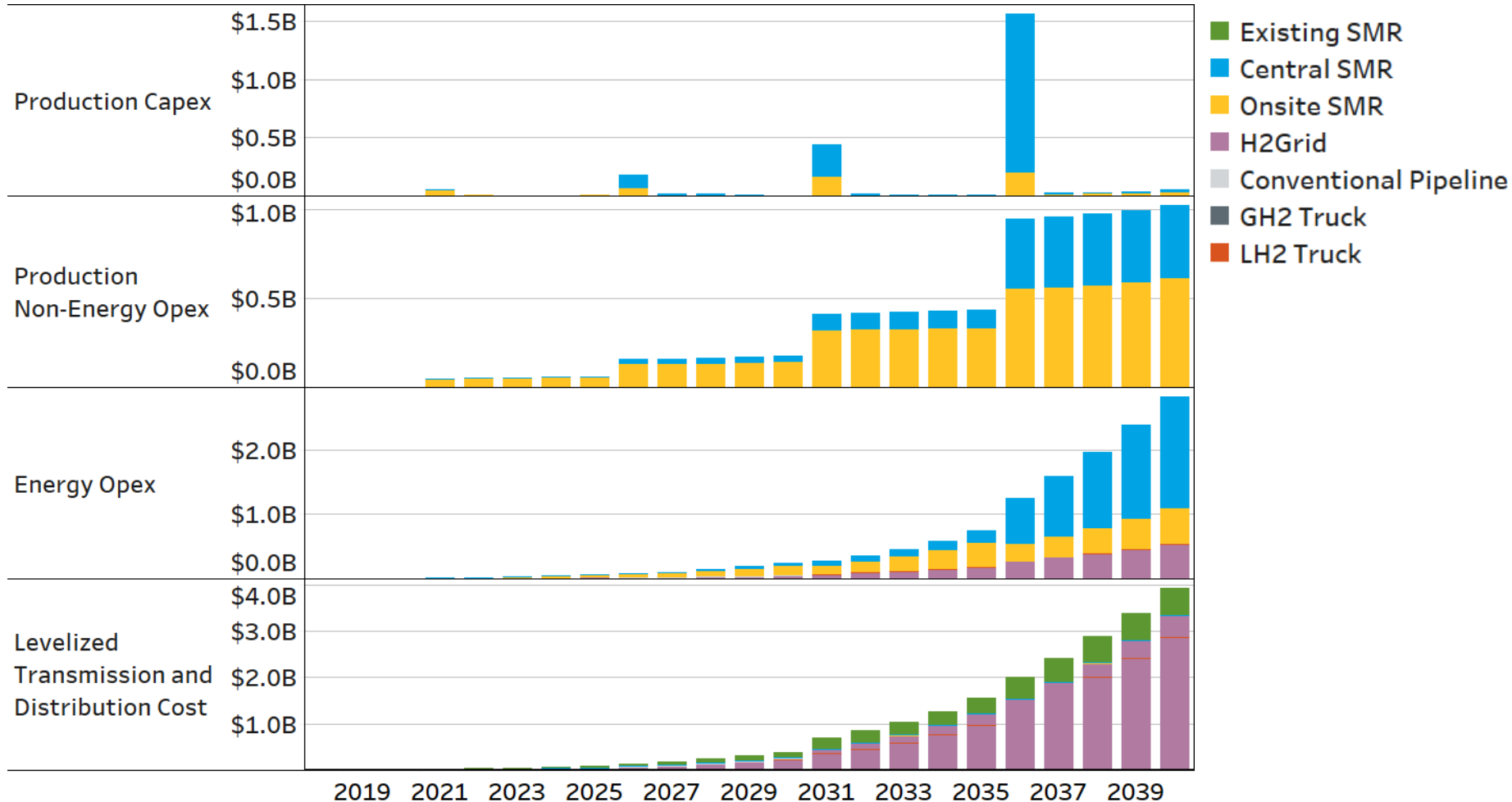

Above is projected distribution of capital expenditure, maintenance (non-energy OPEX), and transmission. Note that transmission expenditures have been levelized for modelling purposes.

SERA Results: Hydrogen Profited Cost For Each Light-Duty FCEV Demand Scenario

Accomplishments 10

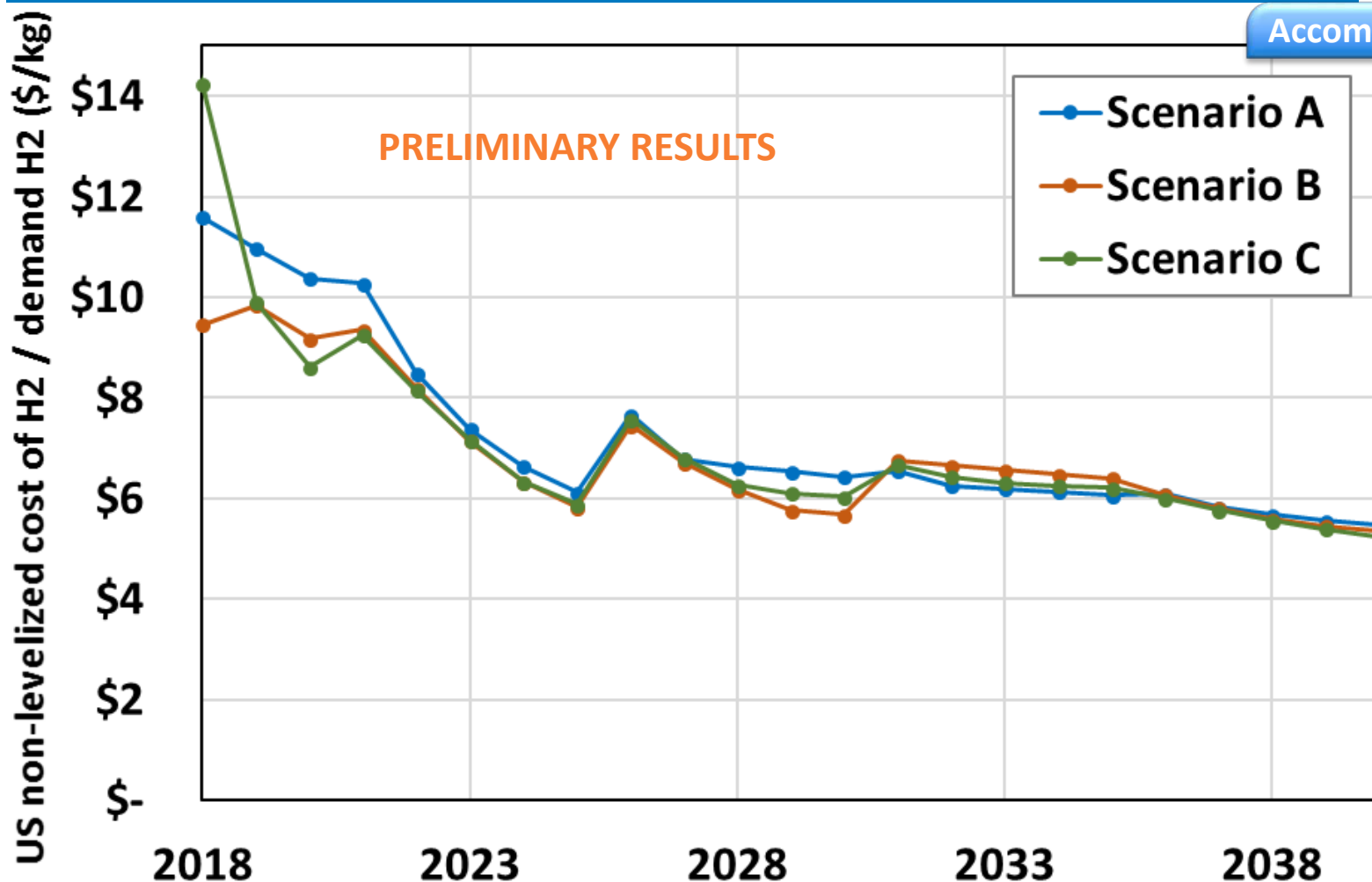

- Spikes in H2 cost are artifact of non-levelized cost used in algorithm along with 5-year capital project outlook criteria.
- Scenario C has slightly lower cost due to economies of scale. Scenario C also has more rural low-density markets, which produce upward pressure on H2 price.

SERA Results: State Success (B) Production, Transmission, and Dispensing Technologies

Accomplishments 11

Production Mix

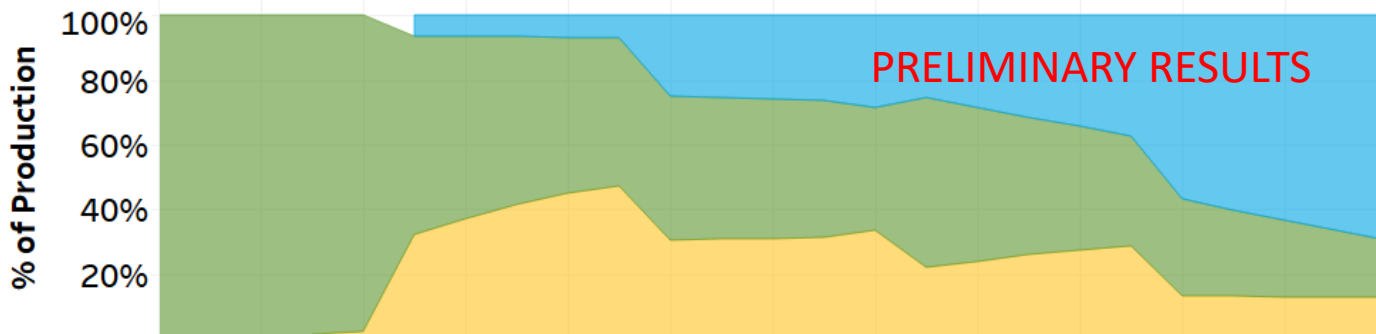

- Central SMR
- Existing Plant
- Onsite SMR

SMR dominates through 2040

Long-Distance Transmission Mix

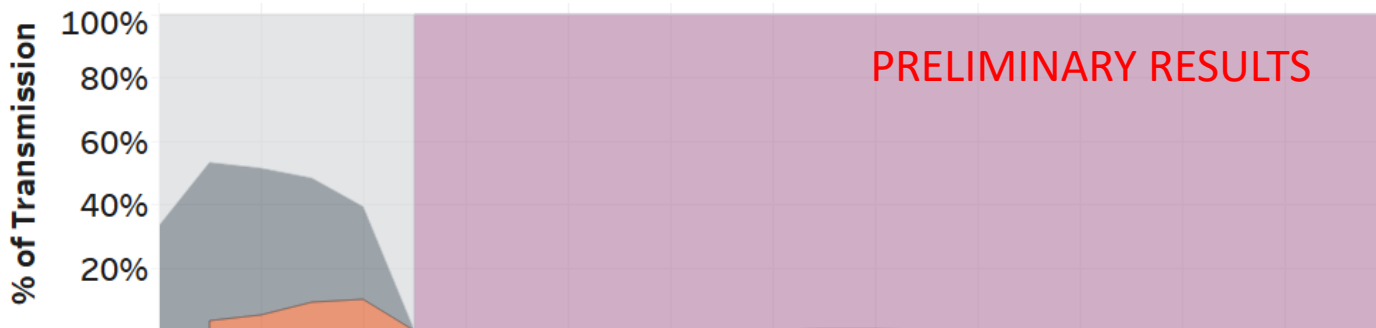

- Conventional Pipeline
- H2Grid
- GH2 Truck
- LH2 Truck

Pipeline *transmission* has highest economic prevalence

Delivery & Dispensing Mix

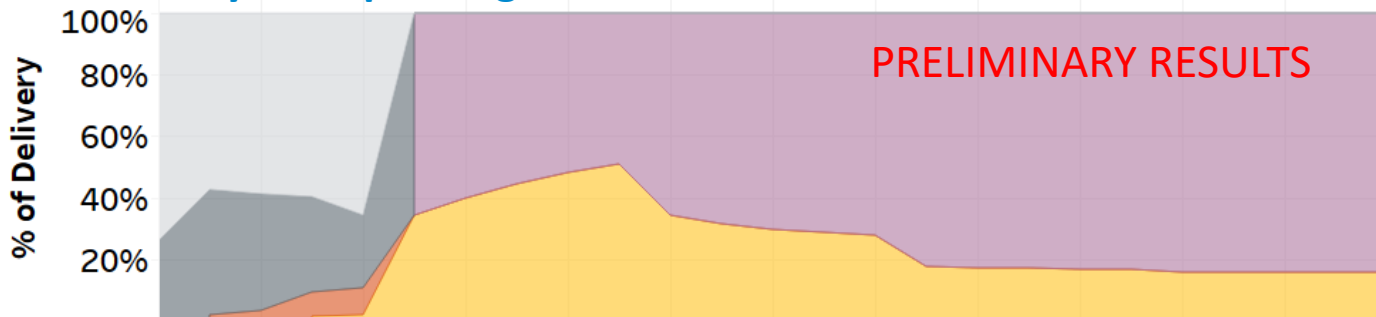

Early *delivery* trucks are replaced by pipeline and onsite SMR production

2018 2020 2022 2024 2026 2028 2030 2032 2034 2036 2038

SERA Results: H2Grid Build-Out In Los Angeles in 2038

Accomplishments 12

PRELIMINARY RESULTS

Characteristics for year	2038
Number of pipeline segments	669
Cumulative length (miles)	1,179.78
Average segment length (miles/segment)	1.76
Delivery throughput (kg/d)	1,251,557
Distribution cost (\$/kg)	\$ 0.51

Los Angeles
Year = 2038

- Station size = 60 - 710 kg/d
- Station size = 710 - 1270 kg/d
- Station size = 1270 - 1900 kg/d
- Station size = 1900 - 2810 kg/d
- Station size = 2810 - 6830 kg/d

H2Grid economically outcompetes other supply chain pathways in major urban areas.

SERA Results: Percent of Stations Connected to the H2Grid (Scenario B: State Success)

Accomplishments 13

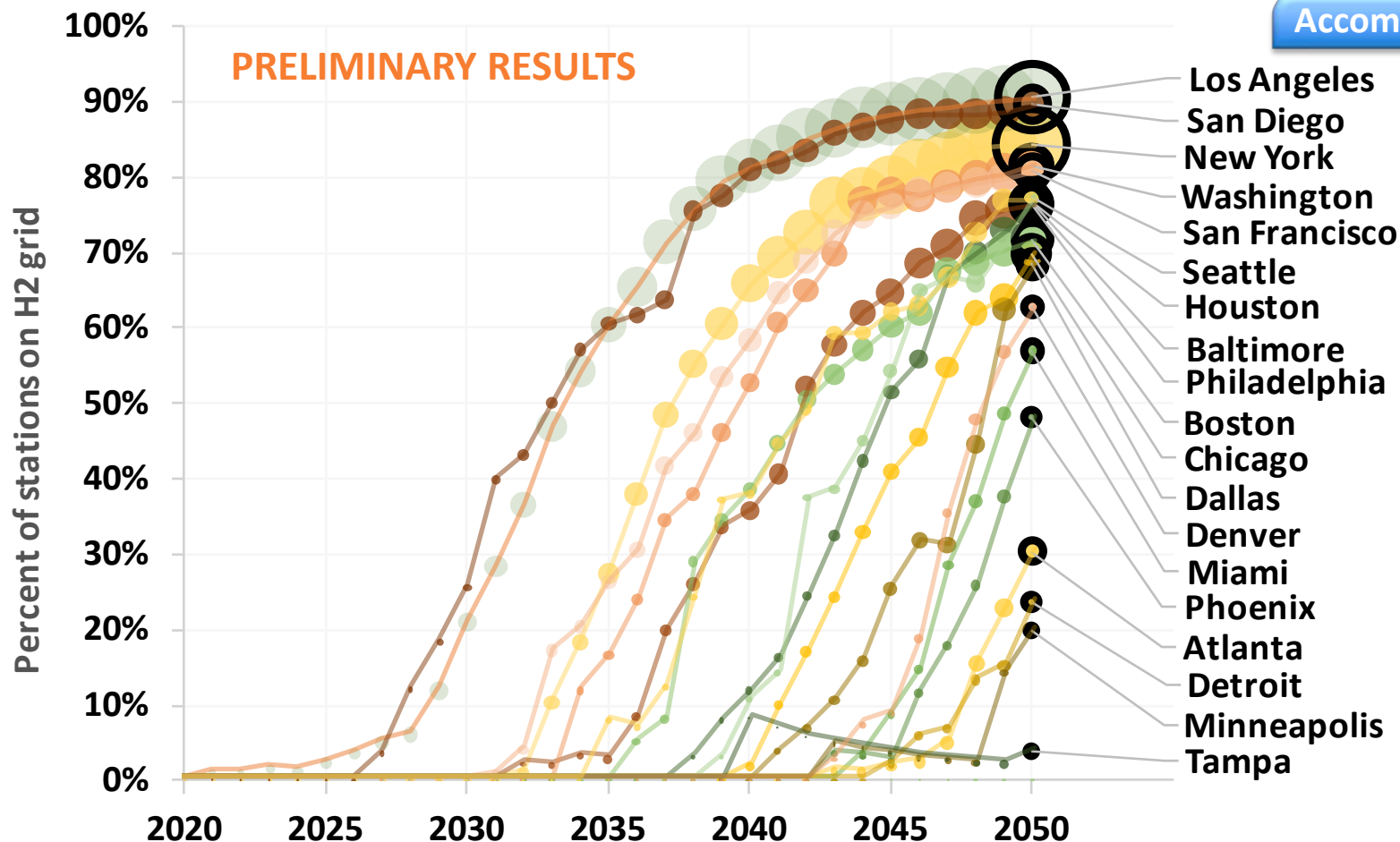

Major urban areas show significant economic advantage from H2Grid past 2030

- Hydrogen demand grows significantly
- Distance between refueling stations shrinks

- **H2@Scale**
 - Modelling framework was developed for this project and H2@Scale. Demand scenarios are also shared between these projects.
- **Argonne National Laboratory**
 - HDSAM and H2A Delivery Components Model
- **California Energy Commission**
 - Leveraging development of SERA analysis capabilities and real-world data updates resulting from support provided to annual CEC/CARB Joint Agency Reports (CEC-funded project)
- **Industry Feedback**
 - CA utility*
 - Industrial gas company*

* Permission has not been obtained to disclose specific contact at this time

Regional Supply-Chain Analysis

- Use non-levelized costs for transmission/delivery technologies (in progress) (e.g. truck delivery infrastructure may serve market for ~2-3 years, but needs 20 years for business case payback)
- Market competition should be addressed to balance economies of scale and competitive landscape (e.g. How many companies operate in proximity to produce competitive pricing)
- Detailed local station placement SERA model needs to be combined with regional supply-chain optimization SERA model to better understand the interface between regional and local supply-chain optimization
- Available capacity and price from existing hydrogen production plants is uncertain and requires sensitivity analysis to determine its impact on supply-chain build-out

H2Grid Approach

- H2Grid is overly conservative (\$2M/mile is used as a pipeline cost floor throughout all US cities but should have regional dependence)
- H2Grid deployment offers individual station advantages, and may more realistically lead station placement algorithms

Regional Supply-Chain Analysis

- Produce considerations for infrastructure competitive time window (e.g. is competitive timeframe for truck deliveries sufficient to recover additional investments)
- Perform economic estimate of retail fuel cost with adjusted financial assumptions (Debt / Equity, Interest rates, Tax rates, Return on equity)
- Complete sensitivity analysis around existing hydrogen plant supply availability and selling price
- Incorporate electrolysis at central electricity production facilities (lower cost power than AEO industrial prices)

H2Grid Approach

- Integrate H2Grid build-out algorithm coupled with station placement logic with the regional supply-chain optimization
- Developed more detailed pipeline cost geographic dependency to better account for urban / rural hydrogen grid penetration

Any proposed future work is subject to change based on funding level

Summary

Relevance

- Analysis of 2018-2040 timeframe supply chain competitiveness
- Forecast infrastructure extent and investment for 3,000 urban areas

Approach

- Prime SERA model with existing 28,000 tonnes/day US and Canada production capacity
- Regionally disaggregate three national light duty market demand scenarios
- Perform competitive optimization modelling for all H2A and HDSAM pathways

Accomplishments and Progress

- Updated and augment all H2A and HDSAM supply chain pathways for consideration
- Introduced H2Grid high-pressure hydrogen delivery pathway
- Hydrogen profited cost was computed at ~\$10/kg in 2018 and \$5.50 in 2040
- Determined likely locations of incremental infrastructure needs between 2018 and 2040
- Quantified investment and operating expenses by technology and supply chain class
- Found large economic driver for H2Grid distribution starting in 2030

Collaboration

- H2@Scale project team; Argonne National Laboratory; California Energy Commission

Proposed Future Research

- Improve H2Grid build-out algorithm
- Incorporate projections of non light duty market hydrogen demands (H2@Scale)
- Align cost of capital and financing to current industry reported status
- Develop scenarios using central electrolysis using central power production prices

Accomplishments and Progress: Responses to Previous Year Reviewers' Comments

Reviewer Comment: The team is using the Hydrogen Analysis (H2A) model to project the price. H2A generates a levelized cost and not a price. The price is set by the market. The team should use a levelized cost range in its analysis to compensate.

Response: SERA uses capital and operating specifications from H2A cases. It compares technology options to yield lowest cost supply chains. It aggregates total regional expenses and applies a 10% profit margin on capital. As such, it simulates a minimum required selling price which reflects a competitive market. As competing goods are alternative fuel transportation, there is little room for any profit margins larger than ~10%.

Accomplishments and Progress: Responses to Previous Year Reviewers' Comments

Reviewer Comment: The team spent a lot of effort looking for hydrogen production numbers, when this information is available on the Hydrogen Analysis Resource Center (HyARC) website, which is now located on H2Tools.org. Other projects that were doing regional analysis used this data.

Response: We have considered HyARC as well. It is a very good public resource. However we have found that the industry report published by IHS Chemical Economics Handbook has the most rigorously collected and regularly updated status information.

Accomplishments and Progress: Responses to Previous Year Reviewers' Comments

Reviewer Comment: The project approach is adequate. However, in the end, production networks will develop based on market conditions, including regulatory requirements, available incentives, and ease of permitting and resource availability, including land for pipelines. These considerations are not yet part of the model.

Response: On the supply side, this modeling effort optimizes on economic drivers and projects direction of economic benefit. Hurdles such as regional permitting variations are indeed not considered explicitly but are rolled into overall costs of pipelines reported by past projects. On the demand side, regulatory and market conditions were considered when estimating light-duty FCEV adoption rates and subsequent hydrogen demand.

Accomplishments and Progress: Responses to Previous Year Reviewers' Comments

Reviewer Comment: Setting up an accurate model for distribution is a large and complex task, which was done well in this project. The project shows the stress points geographically as hydrogen needs increase based on current production. One aspect that was not that clear was how “emerging” technologies were simulated at a centralized scale, given the huge extrapolations that would be required.

Response: The modeling effort includes technologies which are high technology readiness level (TRL) and have peer-reviewed H2A case-studies. As such, speculation of emerging technologies is not part of this analysis. It would be straightforward to add in potential emerging technologies for other case-studies outside of this project scope.

Accomplishments and Progress: Responses to Previous Year Reviewers' Comments

Reviewer Comment: The first and second objectives have not been met, and no information was presented to cover these topics. Nothing was seen in the presentation about calculating hypothetical excess capacity, which would have been interesting to review. Further, there was no information about how capacity expansion would happen to meet a growing demand for FCEVs.

Response: The team looked at multiple means of obtaining excess capacity estimates. This included inquiries to industry, as well as industry monitors. The conclusion of this effort was that surplus capacity is not information in the public realm. It is highly competitively sensitive information and no organization would disclose it. For this analysis, a constant percentage of underutilization was assumed for each plant and that excess supply was available for use. A sensitivity analysis will be completed around this value to understand its importance in hydrogen supply-chain evolution.

Accomplishments and Progress: Responses to Previous Year Reviewers' Comments

Reviewer Comment: The team can give good information. The team seems to be California-specific, with both the California Energy Commission (CEC) and the California Air Resources Board (CARB). Representatives from the Northeast would have been good.

Response: Northeast stakeholders have been consulted as NREL participates in H2USA working groups. This analysis does not take special consideration for any state. It uses physical and economic data layers to arrive at regional results. The underlying analysis request is national scenarios. While CA has leadership status in infrastructure roll-out there are no special considerations for trends and economic impacts for the state.

Accomplishments and Progress: Responses to Previous Year Reviewers' Comments

Reviewer Comment: The integration of the Hydrogen Regional Sustainability (HyReS) project, as well as the further opportunities with H2@ Scale, are very appropriate for the continuation of this work.

Response: It is indeed the case that HyReS and H2@Scale analysis activities leverage this work and the SERA model. The team cross-informs analysis to the above-mentioned projects.

Thank You

www.nrel.gov

NREL/PR-5400-71566

NREL is a national laboratory of the U.S. Department of Energy, Office of Energy Efficiency and Renewable Energy, operated by the Alliance for Sustainable Energy, LLC.



Technical Back-Up Slides

SERA Model Computational Data Flow

Source:

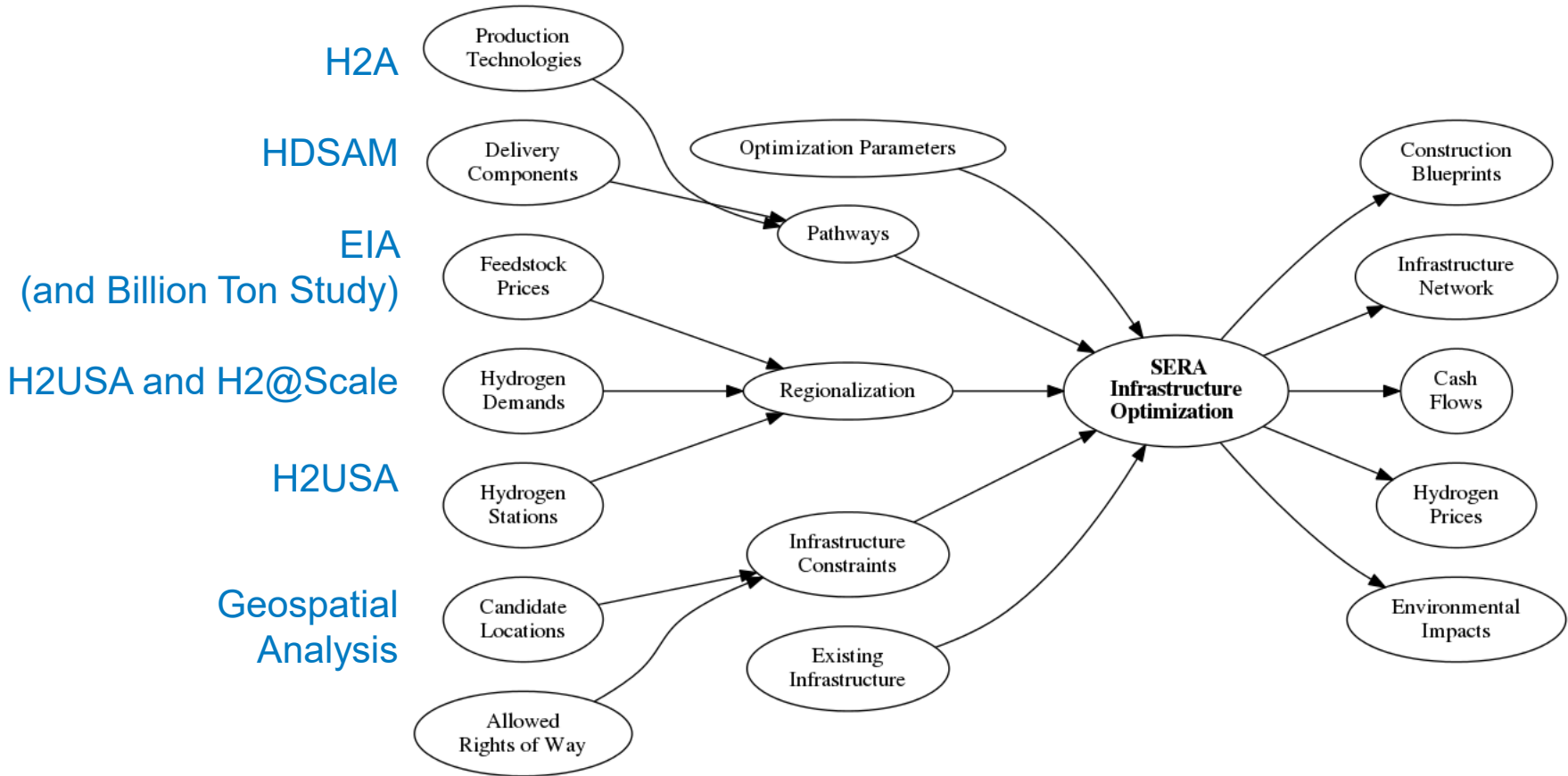

Transmission Pathway Comparison

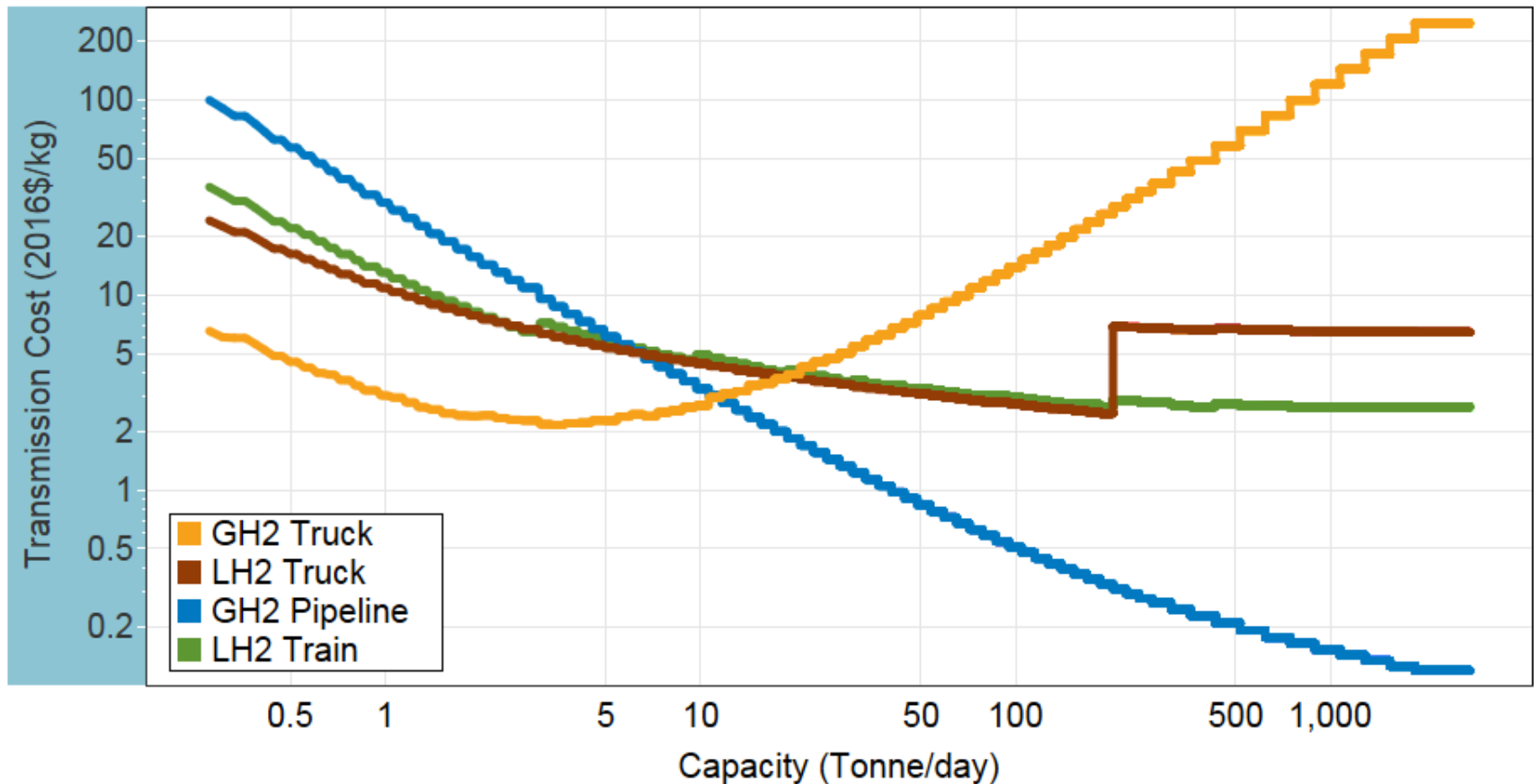

Transmission costs of the primary component technologies in the SERA model assuming a transmission distance of 100km.
Truck delivery is well suited to small capacities and pipeline for high capacity transmission.

Intra-City Distribution Pathway Comparison (no-terminal, or forecourt considerations)

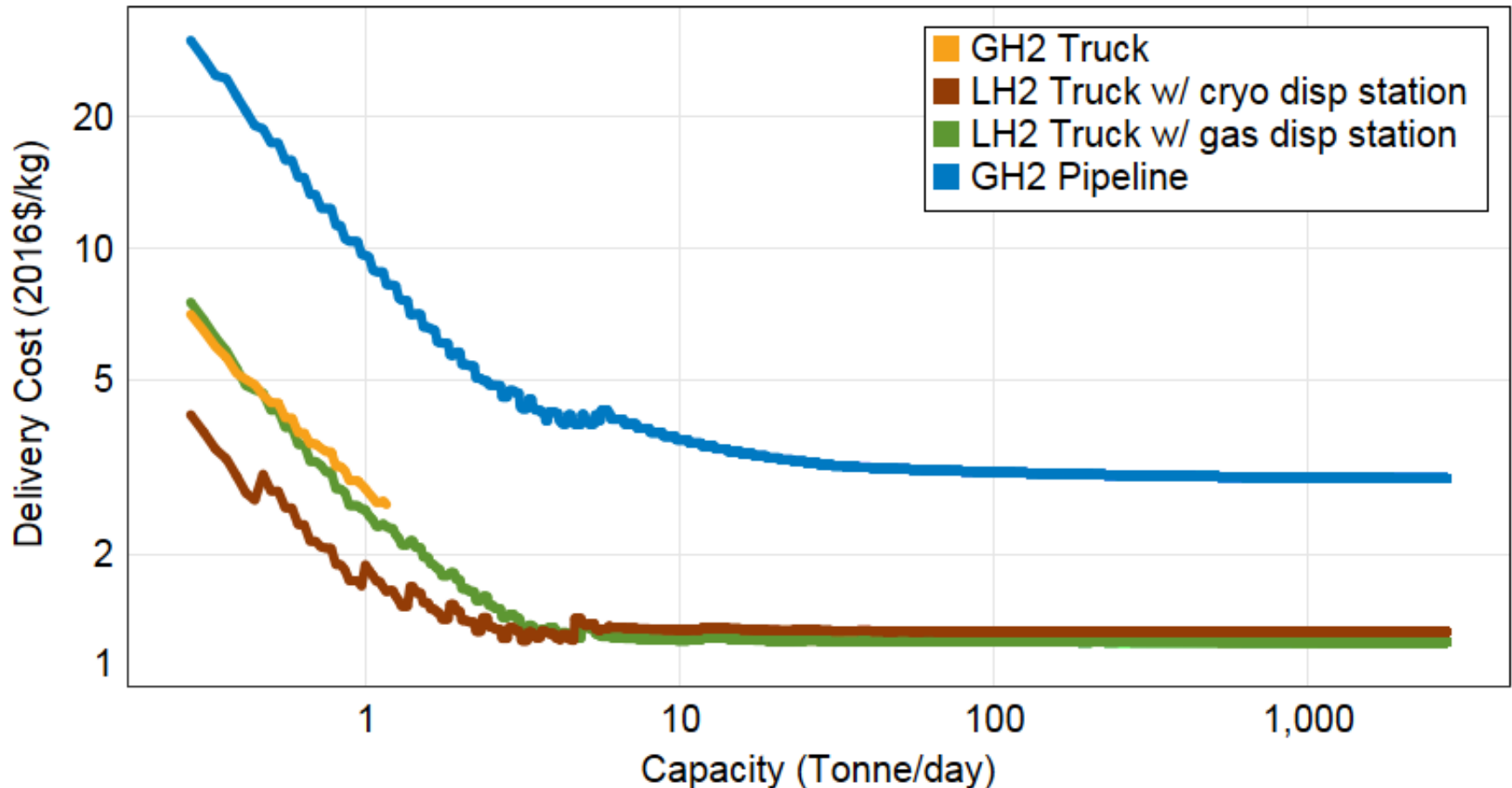

Delivery costs (\$/kg) as a function of capacity for each delivery technology and refueling station type assuming a 5 km delivery distance (transmission costs not included)
Within conventional pathways above, LH2 distribution outcompetes other modes.

H2A Cost Basis by Central H2 Production (Current Tech. Basis)

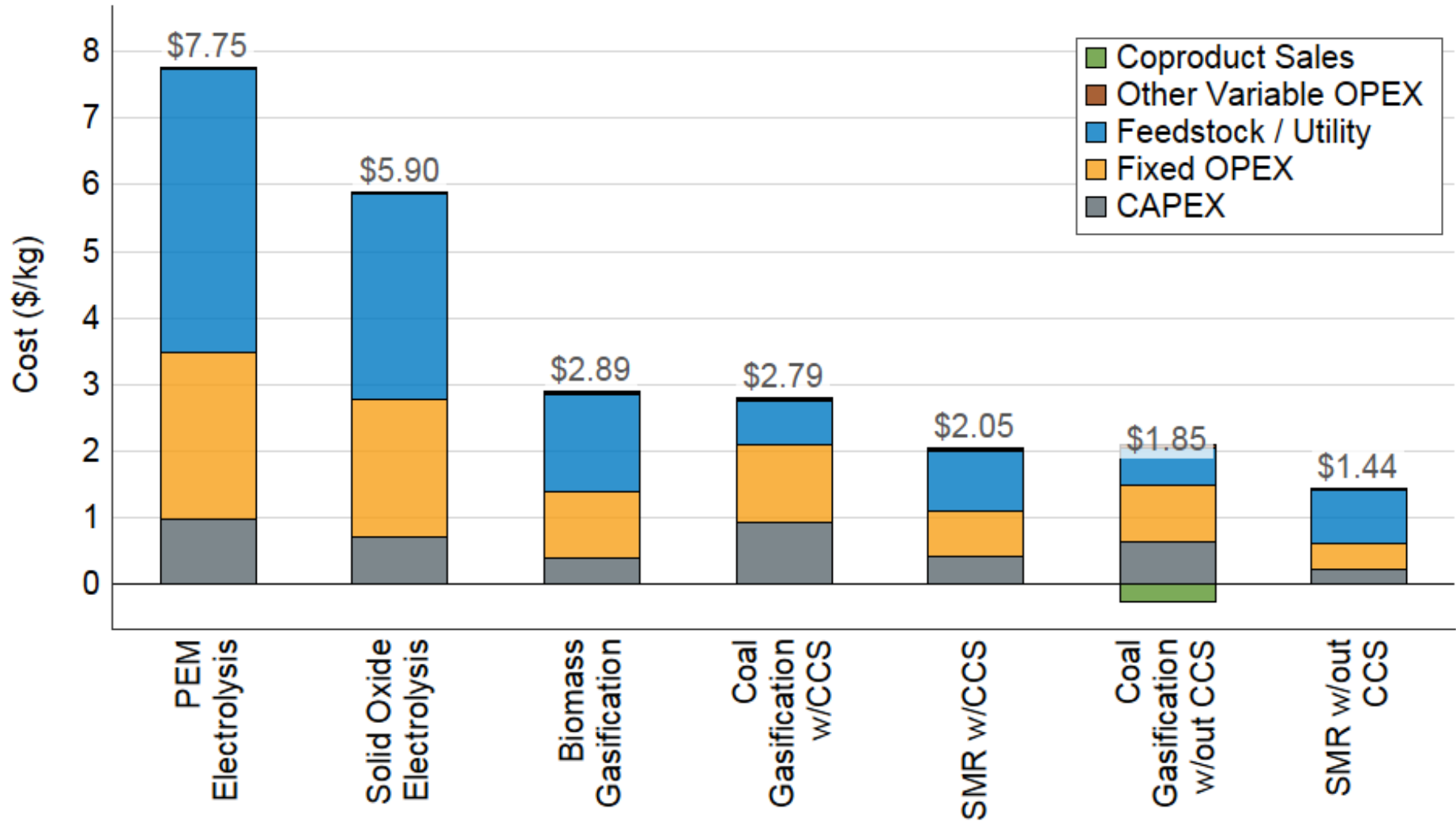

H2A Cost Basis by Central H2 Production (Future Tech. Basis)

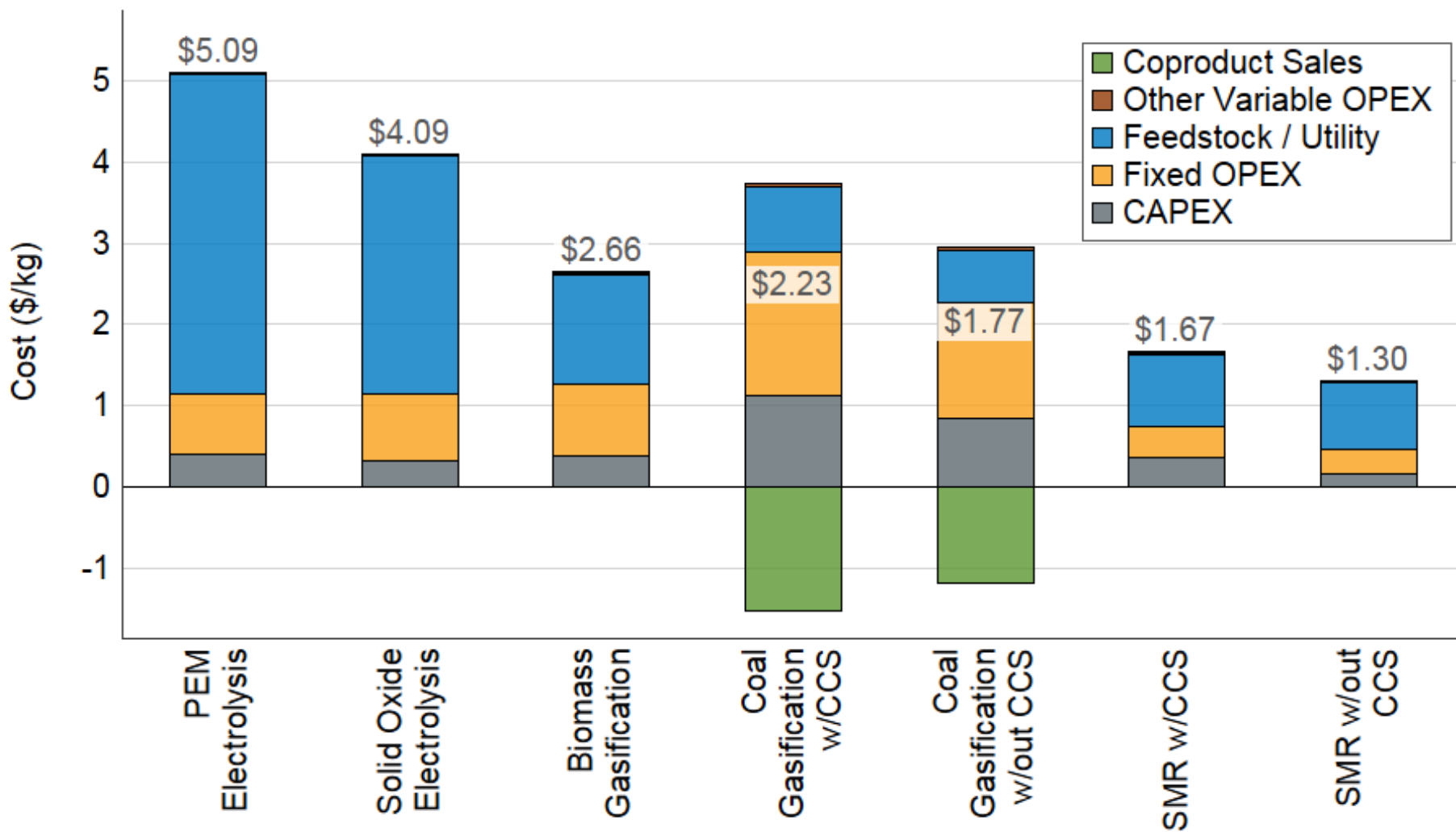

Pipeline Sizing for Hydrogen Grid

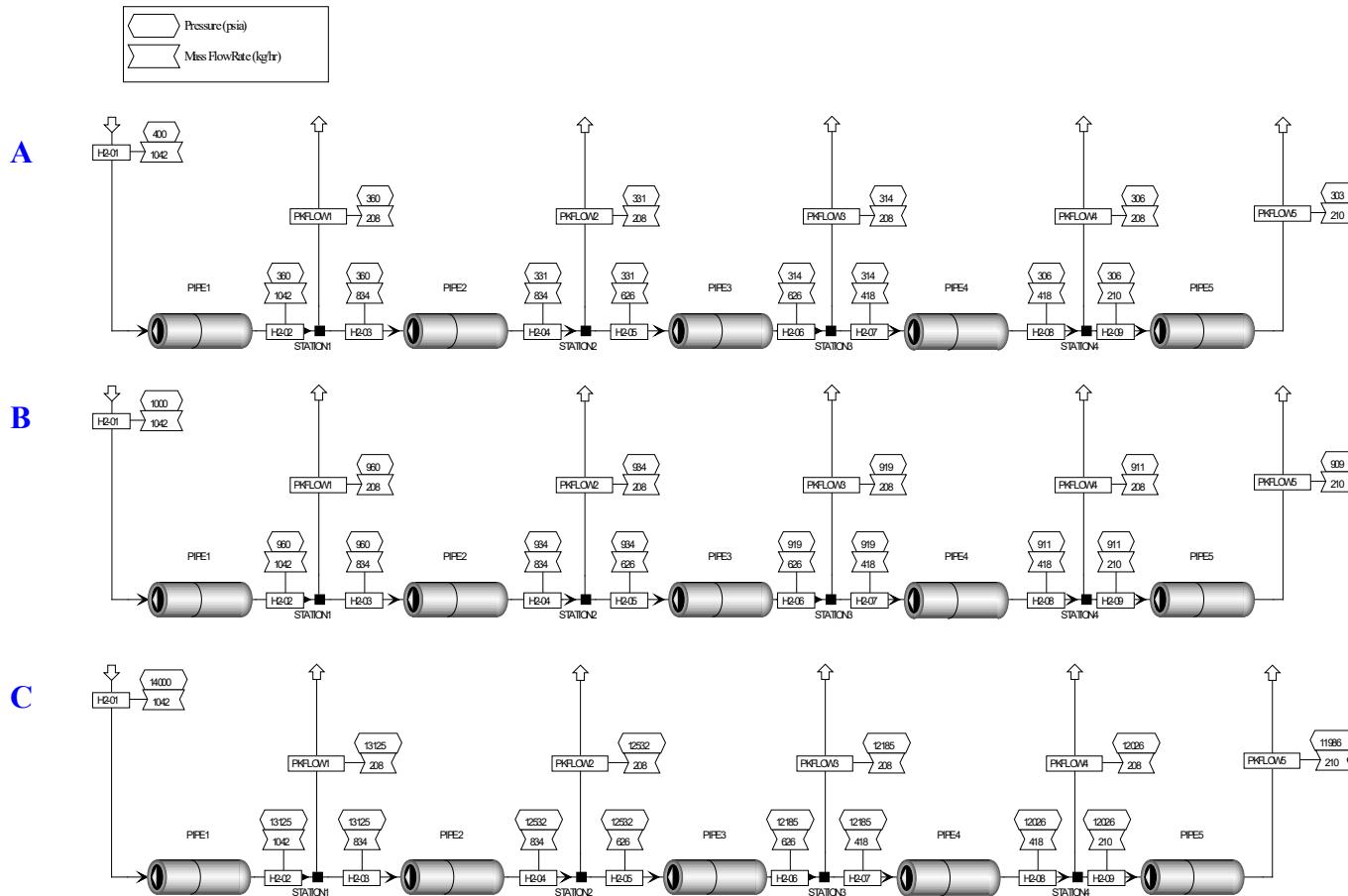

ASPEN modeling of hydrogen pipeline sizing for: (A) 400 psi pipeline inlet pressure (flow is from left to right), (B) 1,000 psi pipeline inlet, and (C) 14,000 psi pipeline inlet. Pipeline inner diameter corresponding with A, B, C scenarios is 3.6 in, 3.0 in, and 1.0 in, respectively.

Pipeline Cost Sources (Oil & Gas Journal, HDSAM)

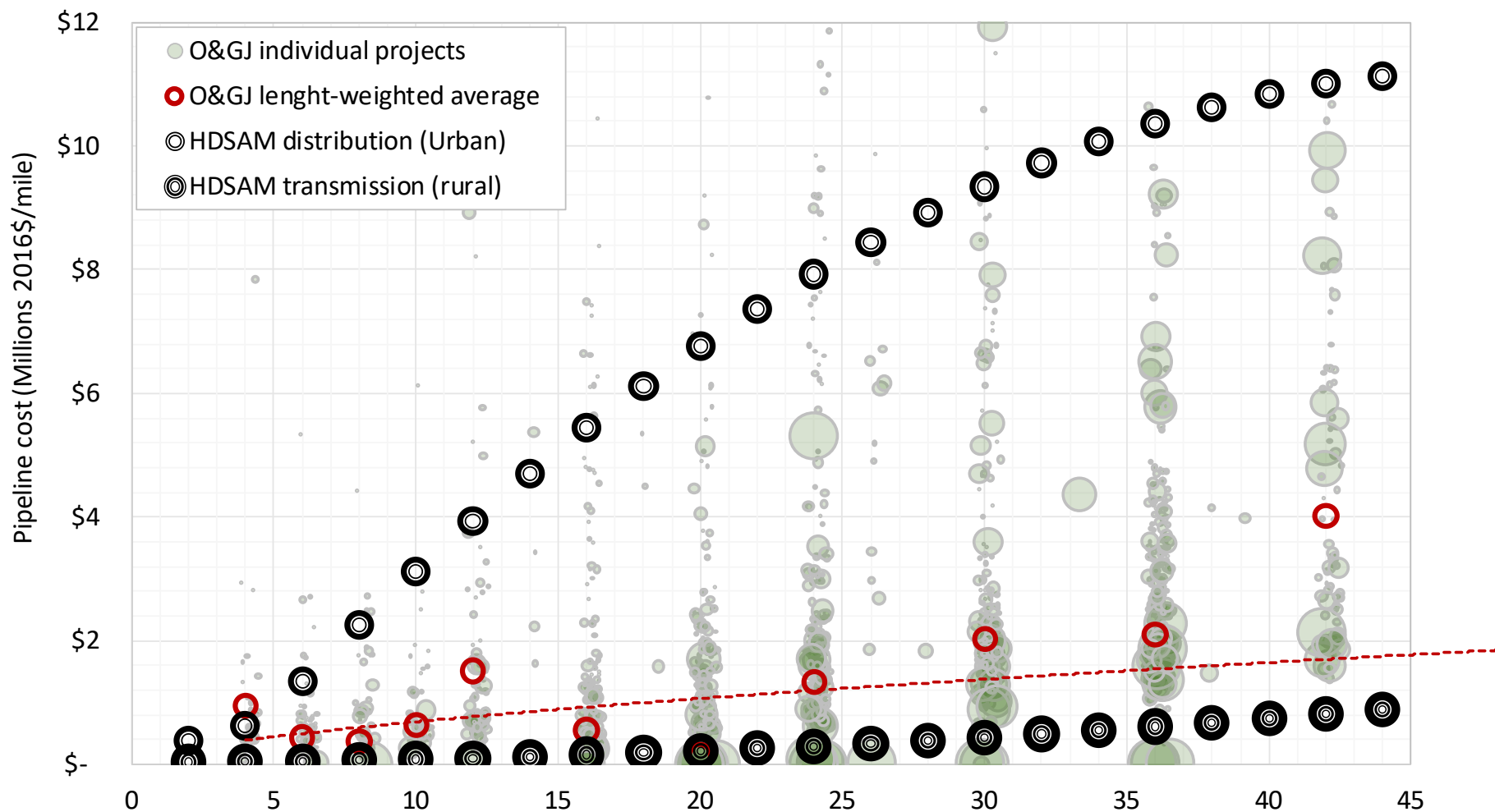

Price floor for pipeline cost of \$2M/mile was used based on industry feedback in context of high density urban settings.

Semi-Central techno-economics benchmark

Pipe diameter scoping parameters:

- 25,000 kg/day flow capacity
- 2 mile length
- Inlet pressure 400 psig
- Pressure drop 100 psig
- Steel: A106 grade B (35,000 psi yield strength)

Estimates:

- pipe inner diameter = 2.6 in
- wall thickness = 0.1 in (3x safety factor)
- H₂ stored in 2 mile pipe = 30 kg
- Pipeline material weight 2 miles = 18,000 lb

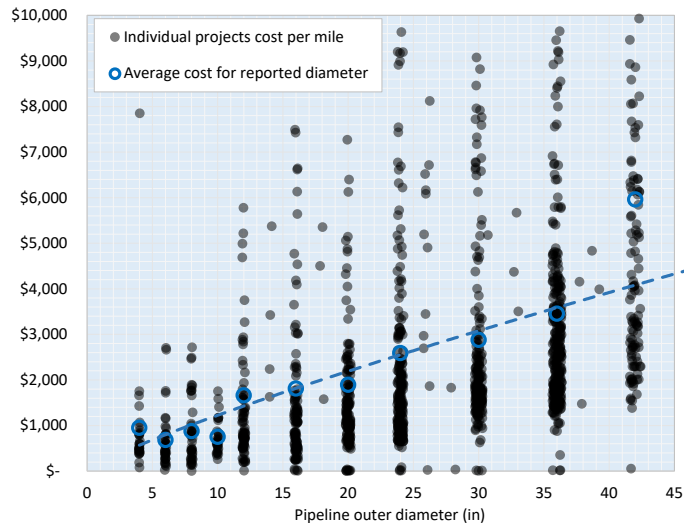
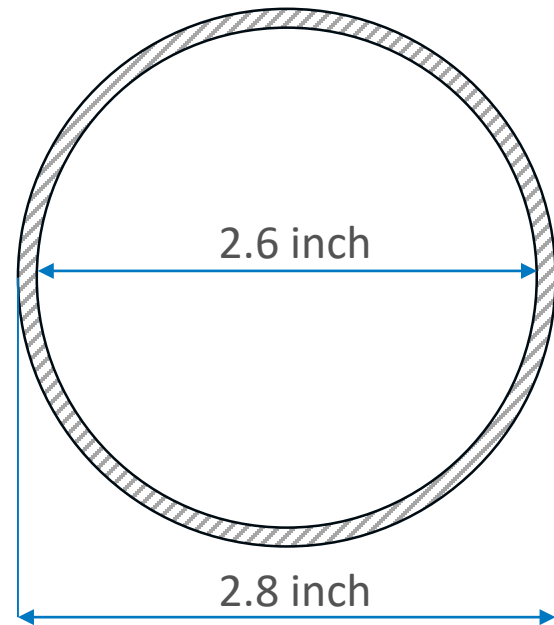

1321 pipeline projects
1991 through 2016
Reported in Oil & Gas Journal
Examples use 6in pipe = \$800K/mile

Take away:

Anticipated requirement: 900 psi, 3"OD
Adopt conservative cost estimate of \$800K/mile
for 6" OD pipe

Centralized Dispensing-Level Compression

Pipe diameter scoping parameters:

- 25,000 kg/day flow capacity
- 2 mile length
- Inlet pressure 13,750 psig
- Delivery pressure 12,000 psig
- Steel: A106 grade B (35,000 psi yield strength)

Estimates:

- pipe inner diameter = 0.94 in
- wall thickness = 0.55 in (3x safety factor)
- H₂ stored in 2 mile pipe = 70 kg
- Pipeline material weight 2 miles = 93,000 lb

Other benefits:

- economies of scale for compressor
 - central compressor is much cheaper than many smaller compressors
 - improved compressor oversight and reliability
- greatly improved back-to-back fill capability
- retail footprint minimized (can site on small urban retail sites)
 - no on-site storage
 - no storage set-back distances
 - no compressor
 - no maintenance access setbacks

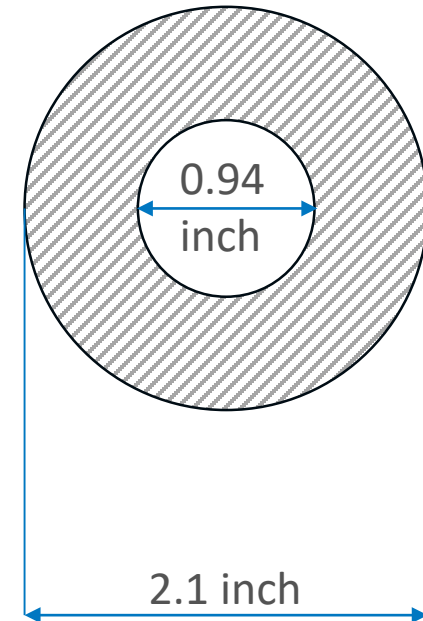

Take away: Centralizing compression can provide significant performance, siting, and economic benefits.

Hydrogen Grid Distribution Pathway

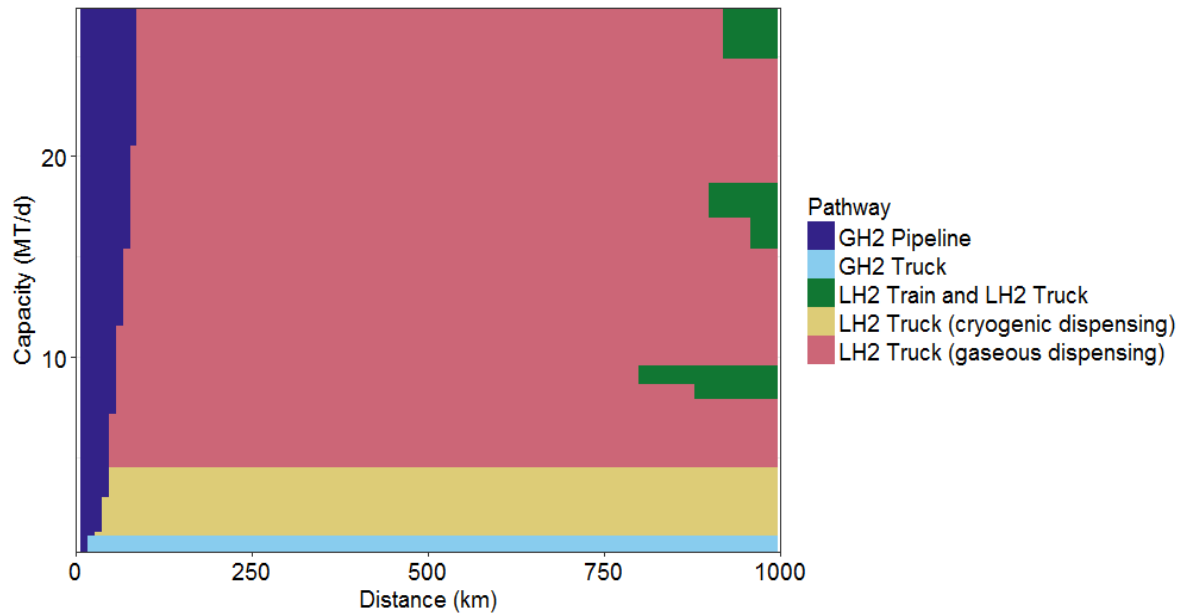

Contour plot of lowest cost pathways for relatively low capacity (top) and high capacity (bottom) hydrogen supply-chain from the point of production to the retail station.

Short intra-urban supply chains are dominated by pipeline delivery

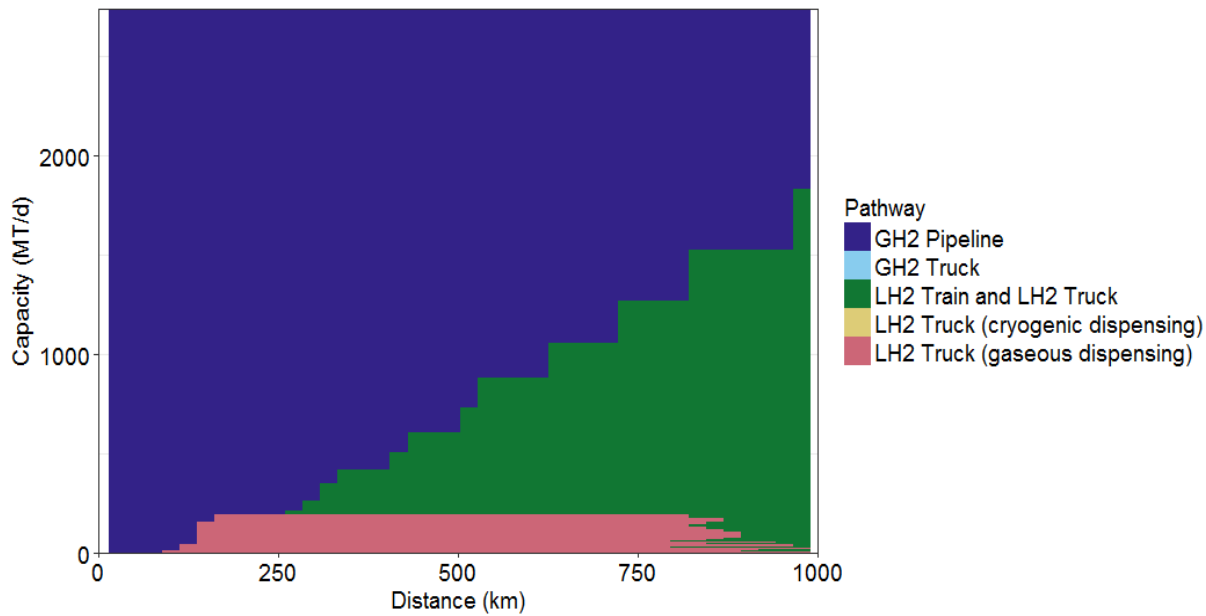

H2 Grid Projection Nationally

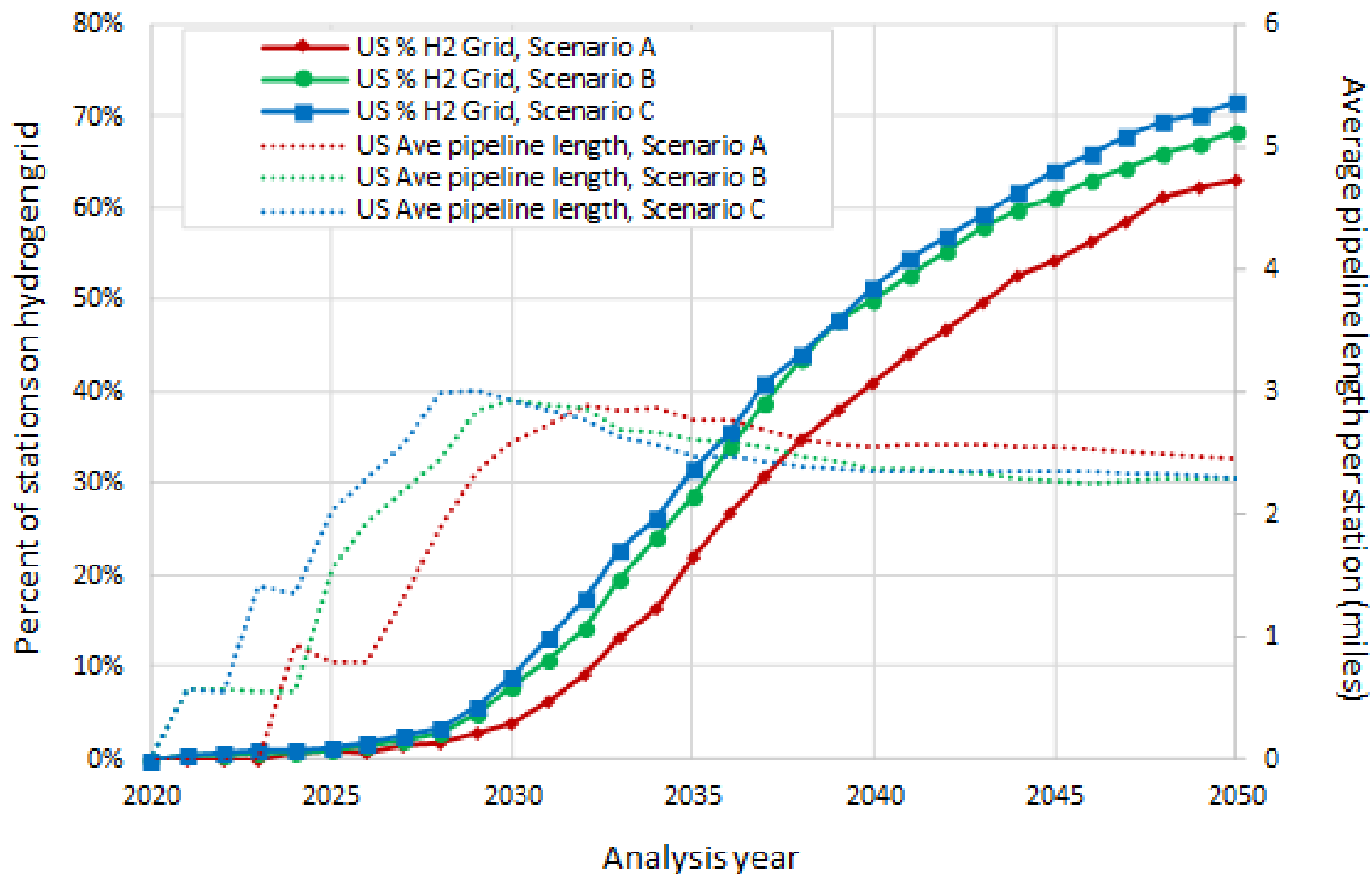

LDV Hydrogen Demand Relative to Supply by Census Division

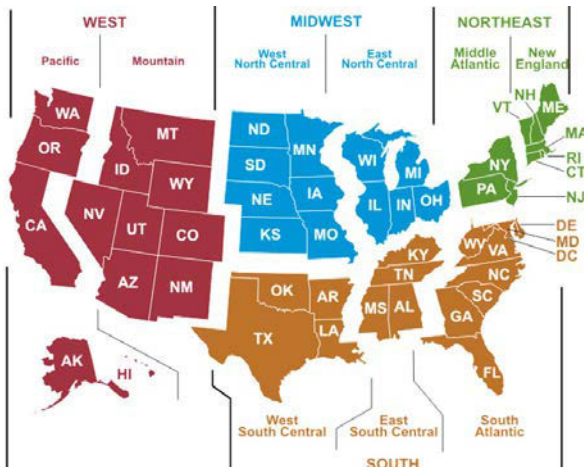
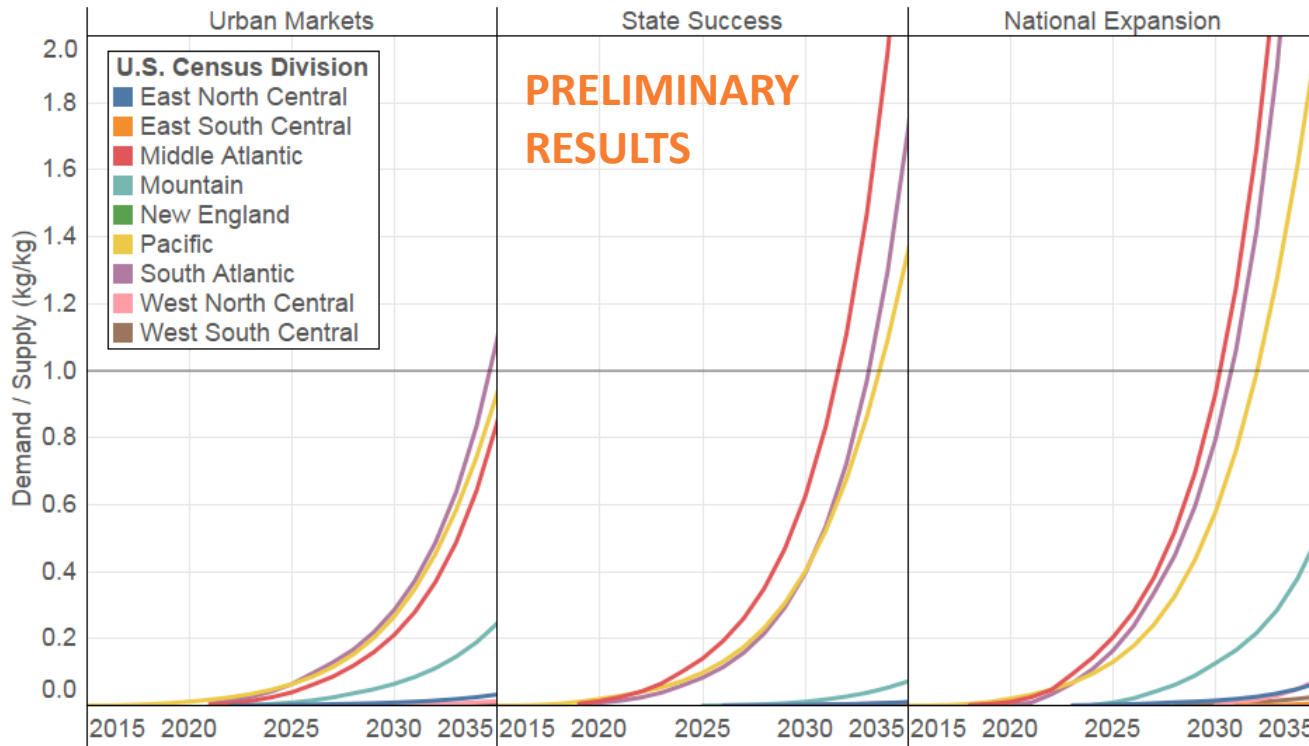

Approximate order of stress on regional capacities:

- New England
- Middle Atlantic
- South Atlantic
- Pacific

Supply Constraints Relative to Product Phase Were Evaluated

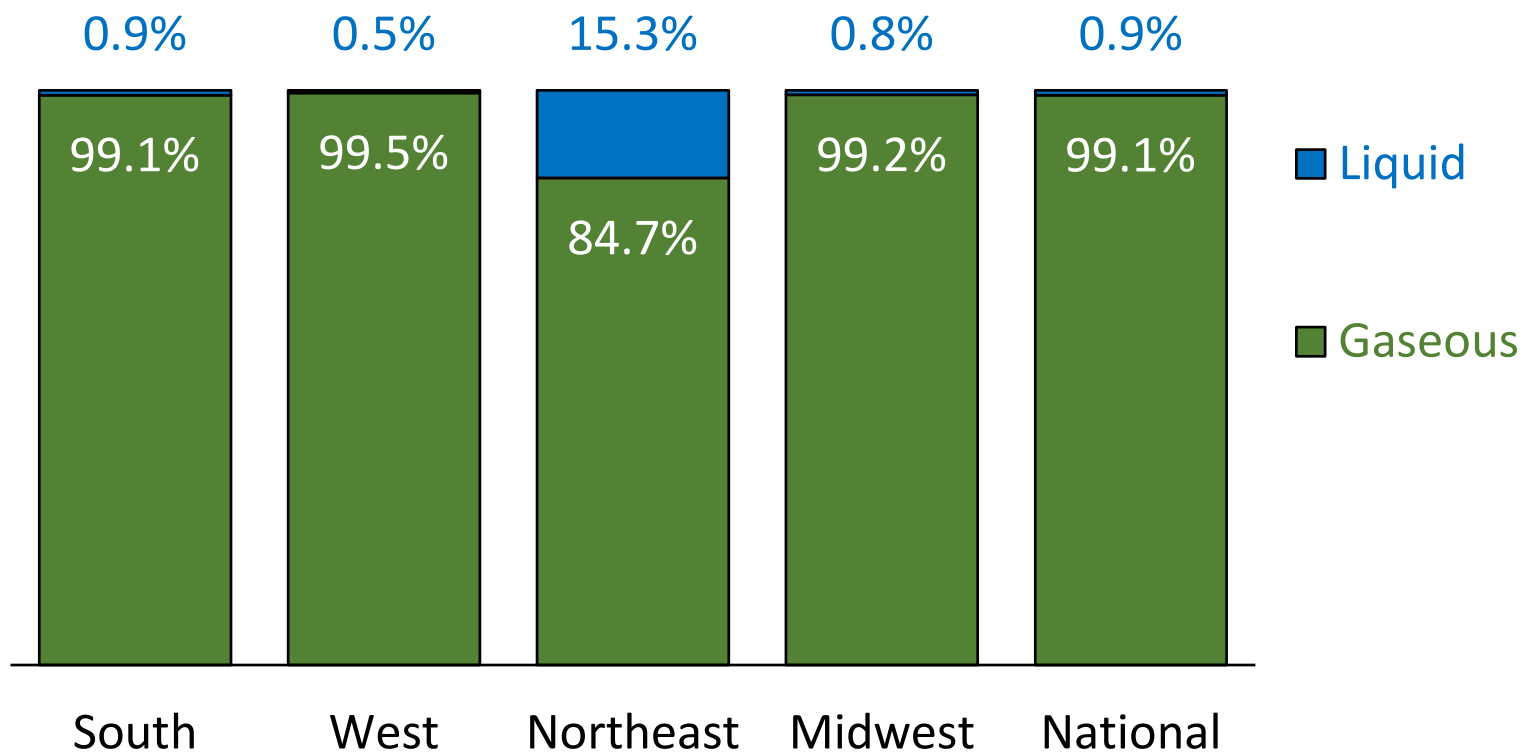

**East Coast likely to see first stresses in regional supply.
Liquid H₂ supply is limiting.**

SERA Results: Hydrogen Profited Cost by Technology (diagnostic scenarios)

US non-levelized cost of H₂ / demand H₂ (\$/kg)

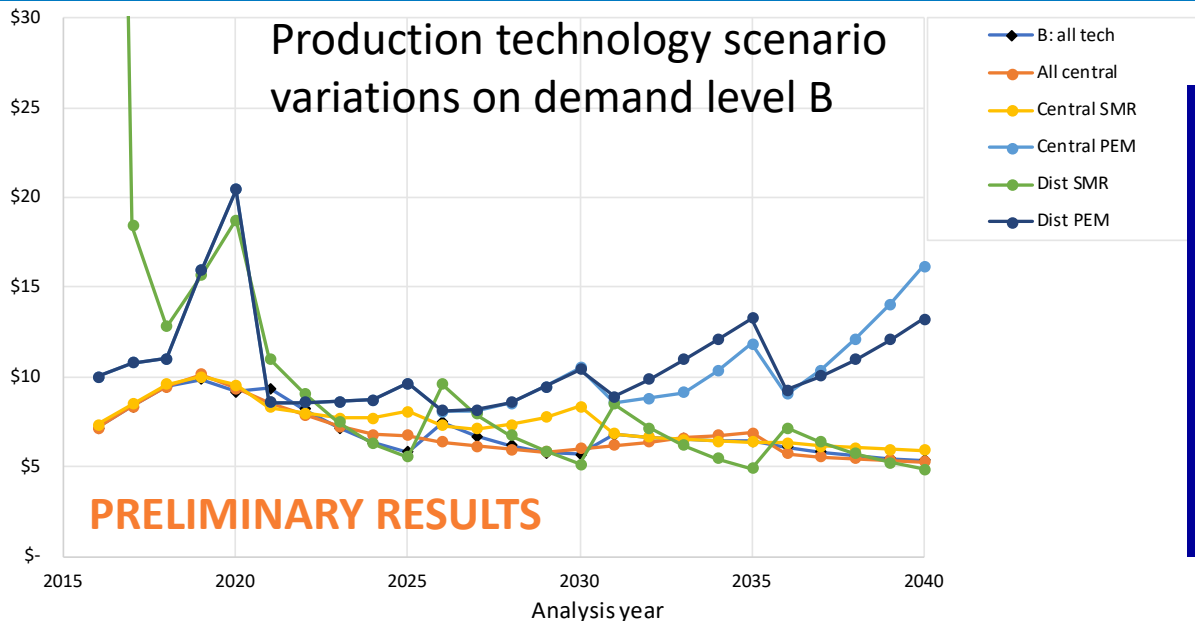

Scenarios reflect single pathways deployed through all the US. For example:

- All Central pathway allows model to build only central production.
- Central coal allows only coal pathway use for H₂ production
- All tech pathway allows all technologies to compete and yields lowest US market costs.

US non-levelized cost of H₂ / demand H₂ (\$/kg)

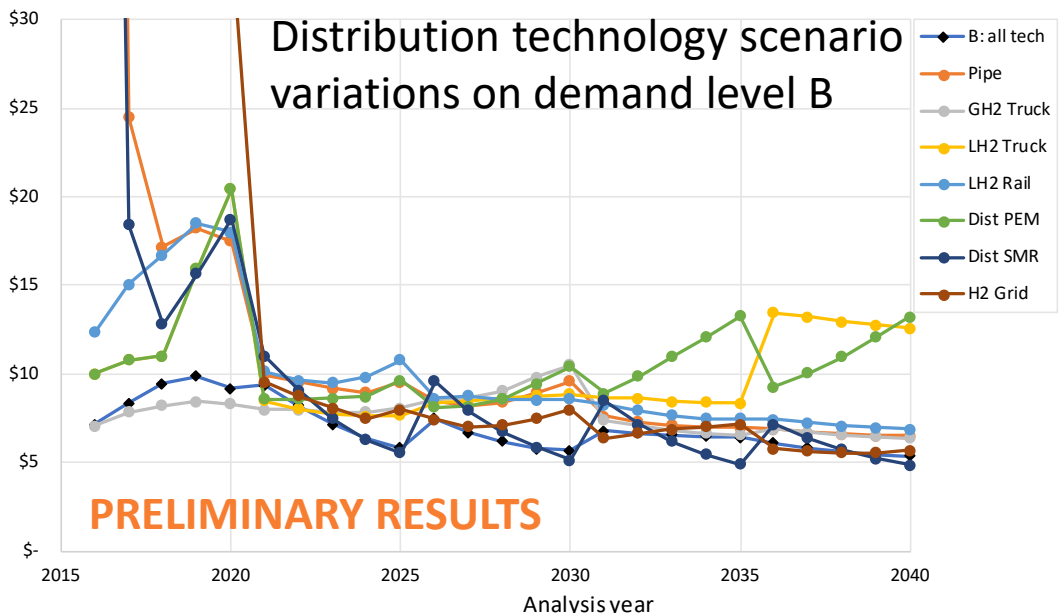

Note that single technology pathways individually yield higher cost than when utilizing technologies according to local conditions.

Tabulated Hydrogen Profited Cost vs. Demand, Technology and Delivery Scenarios (diagnostic scenarios)

PRELIMINARY RESULTS

Year	Demand scenario			Production scenario						Delivery scenario							
	A: all tech	B: all tech	C: all tech	B: all tech	All central	Central SMR	Central PEM	Dist SMR	Dist PEM	B: all tech	Pipe	GH2 Truck	LH2 Truck	LH2 Rail	Dist PEM	Dist SMR	H2 Grid
2016	\$58	\$7.16	>\$100	\$7.16	\$7.16	\$7.32	\$9.99	>\$100	\$9.99	\$7.16	>\$100	\$7.07	\$9.99	\$12.3	\$9.99	>\$100	>\$100
2017	\$13.1	\$8.36	\$18.0	\$8.36	\$8.36	\$8.48	\$10.8	\$18.4	\$10.8	\$8.36	\$24	\$7.84	\$10.8	\$15.1	\$10.8	\$18.4	\$38
2018	\$11.6	\$9.47	\$14.2	\$9.47	\$9.47	\$9.59	\$11.0	\$12.8	\$11.0	\$9.47	\$17.2	\$8.21	\$11.0	\$16.7	\$11.0	\$12.8	\$39
2019	\$11.0	\$9.84	\$9.91	\$9.84	\$10.1	\$10.0	\$15.9	\$15.6	\$15.9	\$9.84	\$18.2	\$8.45	\$15.9	\$18.5	\$15.9	\$15.6	\$39
2020	\$10.4	\$9.18	\$8.62	\$9.18	\$9.37	\$9.52	\$20	\$18.7	\$20	\$9.18	\$17.5	\$8.31	\$20	\$18.0	\$20	\$18.7	\$35
2021	\$10.3	\$9.35	\$9.25	\$9.35	\$8.56	\$8.30	\$8.57	\$11.0	\$8.57	\$9.35	\$9.97	\$7.99	\$8.51	\$10.1	\$8.57	\$11.0	\$9.54
2022	\$8.49	\$8.19	\$8.15	\$8.19	\$7.89	\$7.98	\$8.58	\$9.10	\$8.58	\$8.19	\$9.52	\$7.96	\$8.04	\$9.64	\$8.58	\$9.10	\$8.78
2023	\$7.38	\$7.15	\$7.16	\$7.15	\$7.24	\$7.69	\$8.61	\$7.48	\$8.61	\$7.15	\$9.15	\$7.86	\$7.77	\$9.51	\$8.61	\$7.48	\$8.09
2024	\$6.64	\$6.34	\$6.33	\$6.34	\$6.79	\$7.71	\$8.69	\$6.29	\$8.69	\$6.34	\$8.95	\$7.85	\$7.62	\$9.81	\$8.69	\$6.29	\$7.48
2025	\$6.12	\$5.83	\$5.88	\$5.83	\$6.76	\$8.07	\$9.63	\$5.54	\$9.63	\$5.83	\$9.54	\$8.05	\$7.65	\$10.8	\$9.63	\$5.54	\$7.99
2026	\$7.66	\$7.46	\$7.58	\$7.46	\$6.38	\$7.29	\$8.06	\$9.58	\$8.14	\$7.46	\$8.47	\$8.51	\$8.34	\$8.61	\$8.14	\$9.58	\$7.45
2027	\$6.79	\$6.71	\$6.80	\$6.71	\$6.13	\$7.13	\$8.08	\$7.93	\$8.14	\$6.71	\$8.19	\$8.65	\$8.49	\$8.78	\$8.14	\$7.93	\$6.99
2028	\$6.62	\$6.17	\$6.28	\$6.17	\$5.97	\$7.34	\$8.53	\$6.76	\$8.57	\$6.17	\$8.41	\$9.03	\$8.62	\$8.58	\$8.57	\$6.76	\$7.08
2029	\$6.53	\$5.77	\$6.10	\$5.77	\$5.83	\$7.75	\$9.46	\$5.85	\$9.45	\$5.77	\$8.97	\$9.81	\$8.75	\$8.53	\$9.45	\$5.85	\$7.46
2030	\$6.44	\$5.67	\$6.04	\$5.67	\$6.02	\$8.33	\$10.5	\$5.14	\$10.4	\$5.67	\$9.60	\$10.5	\$8.85	\$8.60	\$10.4	\$5.14	\$7.98
2031	\$6.56	\$6.77	\$6.68	\$6.77	\$6.17	\$6.81	\$8.56	\$8.47	\$8.90	\$6.77	\$7.60	\$7.40	\$8.63	\$8.28	\$8.90	\$8.47	\$6.38
2032	\$6.25	\$6.65	\$6.43	\$6.65	\$6.39	\$6.66	\$8.80	\$7.17	\$9.87	\$6.65	\$7.30	\$7.09	\$8.63	\$7.94	\$9.87	\$7.17	\$6.64
2033	\$6.20	\$6.56	\$6.31	\$6.56	\$6.59	\$6.53	\$9.12	\$6.19	\$10.9	\$6.56	\$7.09	\$6.84	\$8.45	\$7.66	\$10.9	\$6.19	\$6.86
2034	\$6.14	\$6.47	\$6.26	\$6.47	\$6.73	\$6.43	\$10.3	\$5.46	\$12.1	\$6.47	\$7.00	\$6.66	\$8.37	\$7.50	\$12.1	\$5.46	\$7.03
2035	\$6.07	\$6.41	\$6.21	\$6.41	\$6.89	\$6.37	\$11.8	\$4.92	\$13.3	\$6.41	\$6.95	\$6.55	\$8.34	\$7.45	\$13.3	\$4.92	\$7.15
2036	\$6.09	\$6.08	\$6.01	\$6.08	\$5.71	\$6.31	\$9.05	\$7.17	\$9.27	\$6.08	\$6.86	\$6.89	\$13.5	\$7.44	\$9.27	\$7.17	\$5.79
2037	\$5.83	\$5.81	\$5.76	\$5.81	\$5.55	\$6.16	\$10.4	\$6.35	\$10.1	\$5.81	\$6.70	\$6.71	\$13.2	\$7.22	\$10.1	\$6.35	\$5.64
2038	\$5.67	\$5.59	\$5.56	\$5.59	\$5.43	\$6.05	\$12.1	\$5.72	\$11.0	\$5.59	\$6.59	\$6.57	\$13.0	\$7.06	\$11.0	\$5.72	\$5.56
2039	\$5.56	\$5.45	\$5.39	\$5.45	\$5.35	\$5.97	\$14.1	\$5.22	\$12.1	\$5.45	\$6.52	\$6.46	\$12.8	\$6.95	\$12.1	\$5.22	\$5.56
2040	\$5.46	\$5.36	\$5.25	\$5.36	\$5.29	\$5.90	\$16.1	\$4.83	\$13.2	\$5.36	\$6.49	\$6.37	\$12.6	\$6.87	\$13.2	\$4.83	\$5.67

Note: Distributed SMR shows small advantage in some years, as emerging low-density come online. This technology is however outcompeted by other pathways after an introductory period.