

NREL Multiphysics Modeling Tools and ISC Device for Designing Safer Li-Ion Batteries

Advanced Vehicles & Fuels Research
Energy Storage

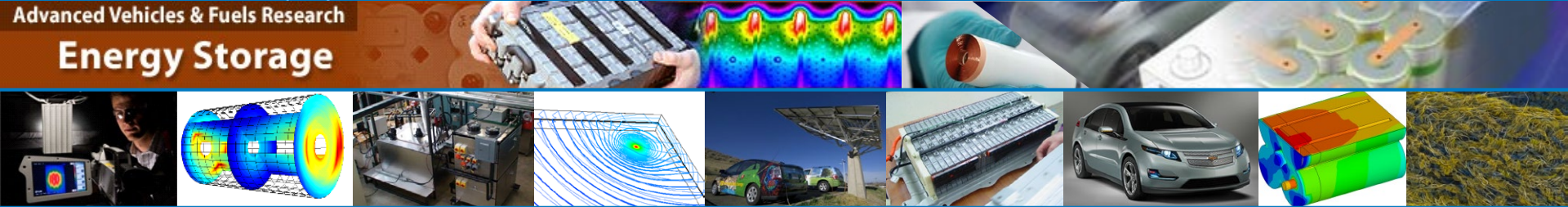

Ahmad A. Pesaran, Ph.D.
Chuanbo Yang
National Renewable Energy Laboratory
Golden, Colorado

March 24, 2016

BATTERY SAFETY

Innovations to Improve Lithium Battery Safety from Cell to Systems

NREL Lithium Ion Battery Safety Portfolio - 1

- Electrochemical-thermal (ETC) models

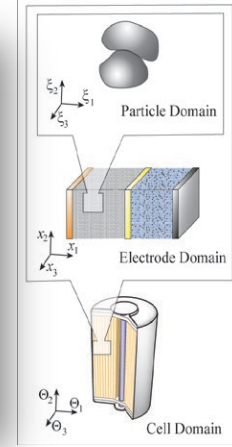
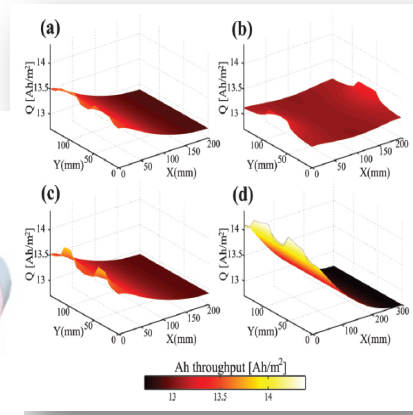
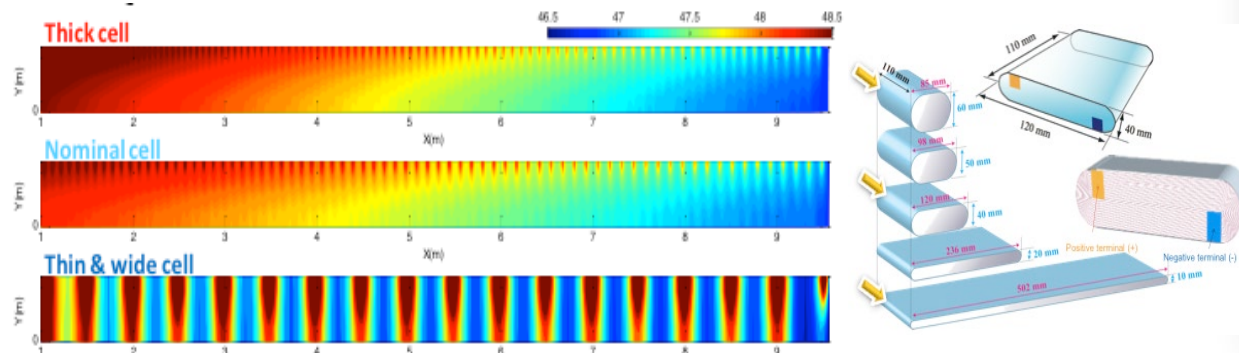

- Computer Aided Engineering for Batteries (CAEBAT)

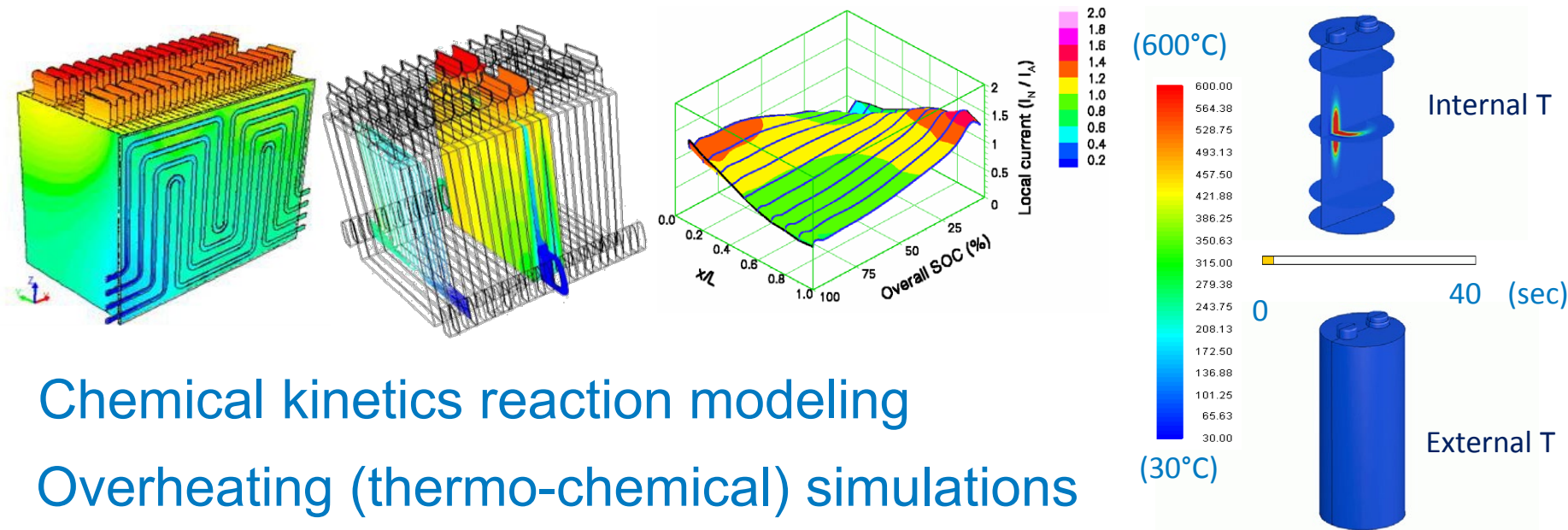

- Chemical kinetics reaction modeling
- Overheating (thermo-chemical) simulations

NREL Lithium Ion Battery Safety Portfolio - 2

- Internal short circuit modeling

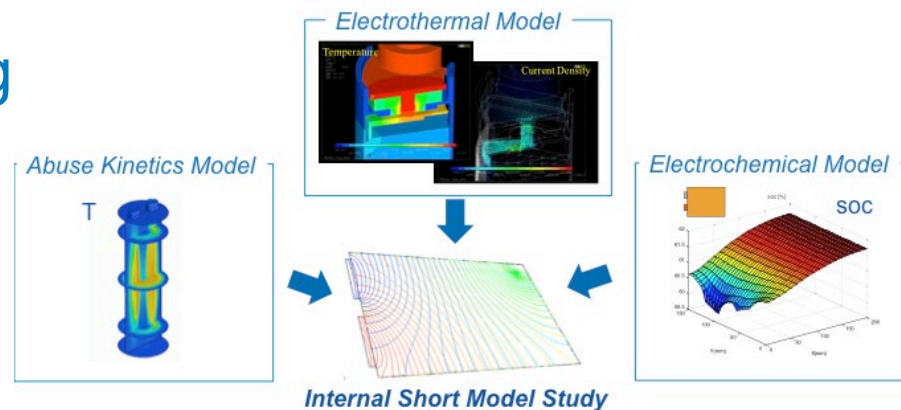

- Mechanical-ETC models for crush simulation

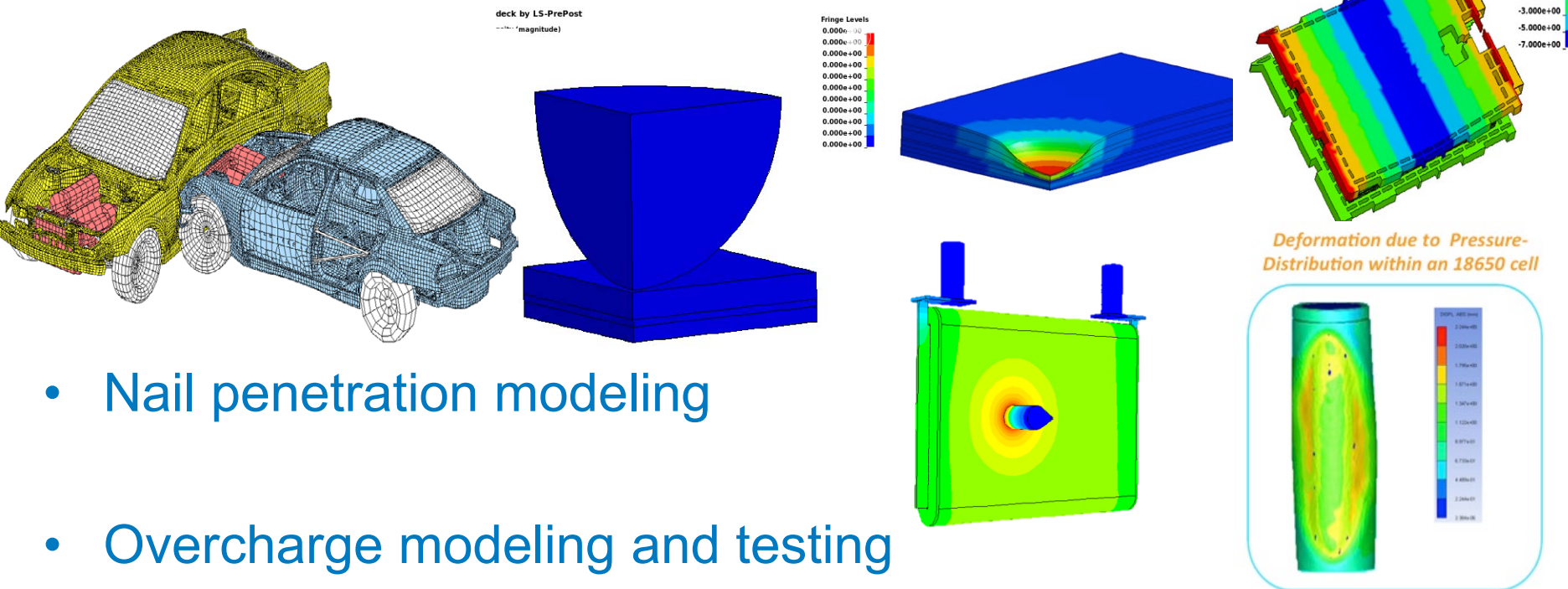

- Nail penetration modeling
- Overcharge modeling and testing

NREL Lithium Ion Battery Safety Portfolio - 3

- Cell-Cell thermal propagation modeling
- Accelerating rate calorimeter testing

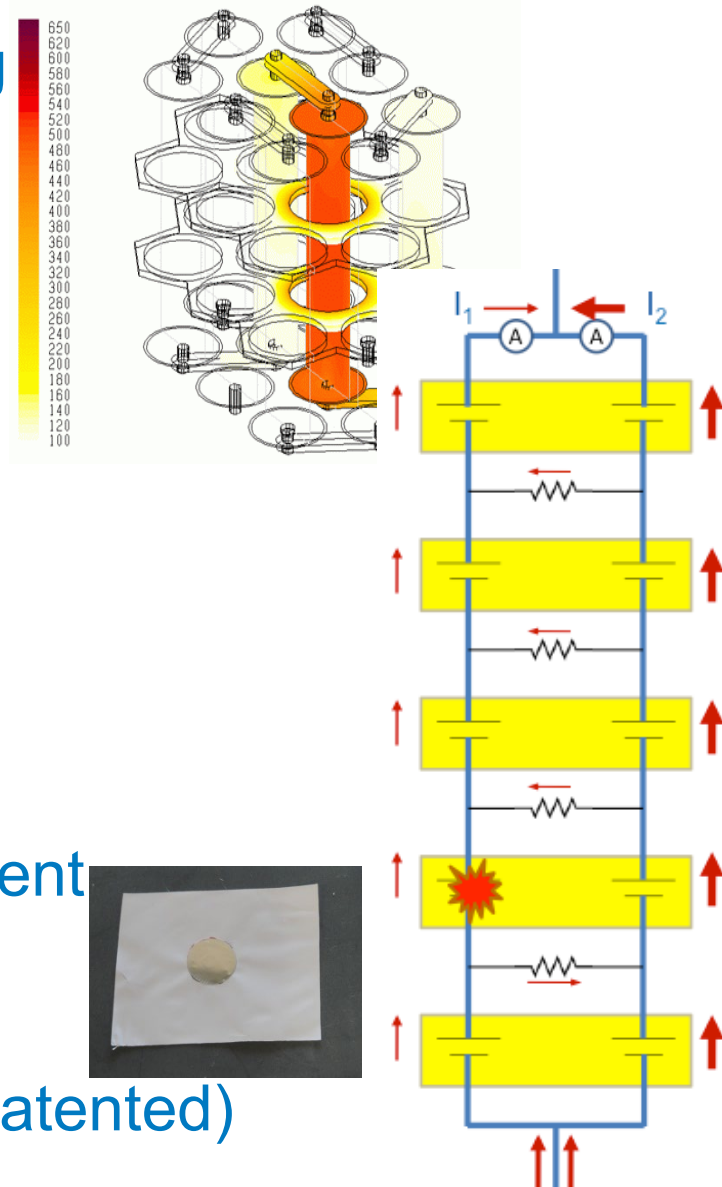
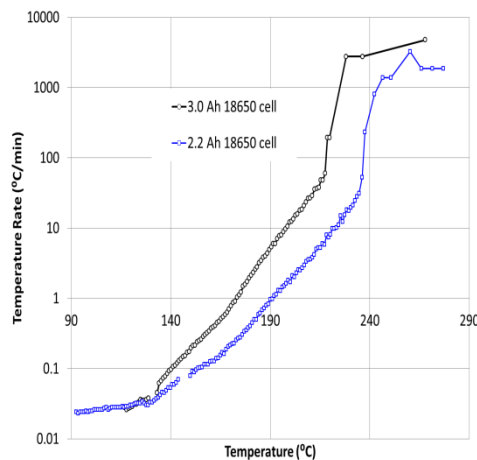

- Fail safe design architecture development

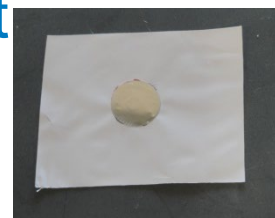

- Battery Internal Short Circuit Device (Patented)

Objective/Outline

- Show how NREL safety tools supported our industry partner, Cadenza Innovation LLC



- Provide further details on
 - NREL Battery ISC Device
- Discuss validation study with Cadenza
 - Introduce the novel Cadenza architecture
 - Cell-to-cell thermal propagation modeling
 - Comparison with abuse experimental data
 - Demonstrate safe behavior of the Cadenza cell

Motivation for Battery ISC Device

- One changing safety issue is internal short circuit (ISC)
- New designs/materials R&D underway to improve ISC safety
- The challenge is how to evaluate these improvements
- Existing methods to trigger ISC (penetration or crush) perceived by many to be deficient and not representative
- NREL/NASA developed a very thin, implantable “thermal switch” to emulate ISC
- Use the ISC emulator to evaluate cell and module safety improvements

Come up with a better way to evaluate the behavior of cells due to manufacturing defects and field failures

NREL Cell Internal Short Circuit Development

- Small, low-profile and implantable into Li-ion cells during assembly
- Key component is an electrolyte-compatible phase change material (PCM)
- The ISC device can be placed anywhere in a cell to create any of 4 types of ISC
- The ISC device is triggered by heating the cell above PCM's melting temperature (of about 40°C – 60°C)
- When PCM melts, a current path is created between positive and negative sides



Patented ISC Device

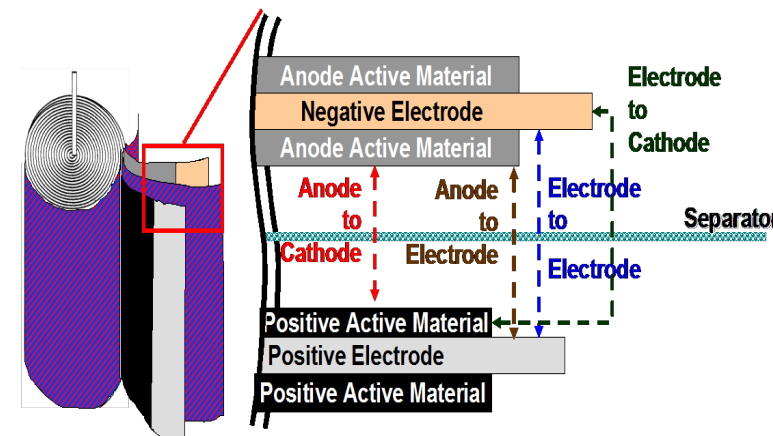
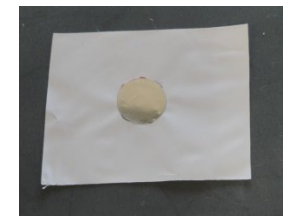

Spiral wound battery shown – can also be applied to prismatic batteries.

NREL/NASA ISC Device Design

Negative current collector (Cu)

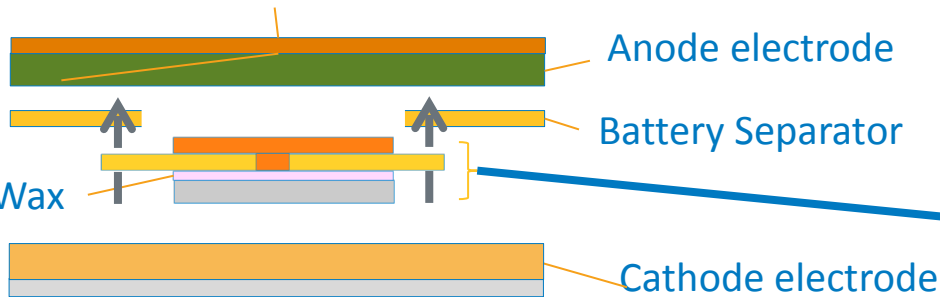

Positive current collector (Al)

Graphics are not to scale
and for illustration only

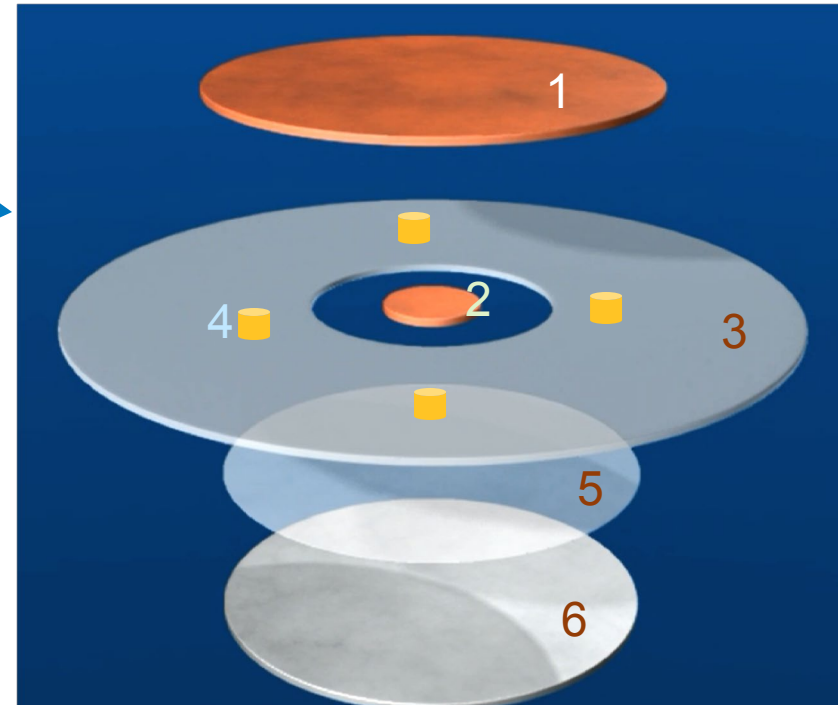
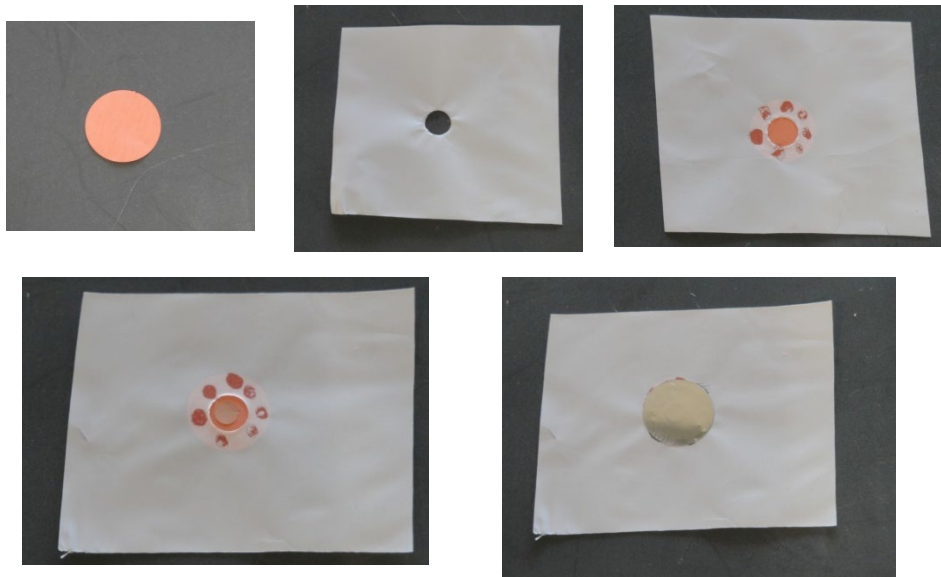

Top to Bottom:

1. Copper Disc
2. Copper Puck
3. Battery Separator
4. Adhesive/glue
5. Phase Change Material (wax)
6. Aluminum Disc

ISC Device Example for a Type 1 Short

Anode active material to Cathode active material Type 1

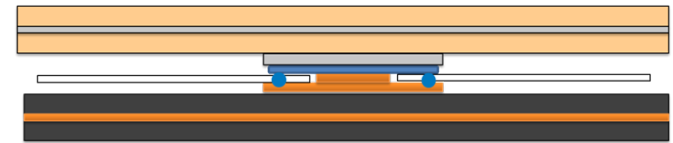

Cathode Active layer 37.0 microns



Cathode Active layer 37.0 microns

96.2 micron



Aluminum ISC disk 25.4 microns



Separator 20 microns



Wax layer ~20 microns

Cu Puck 25.4 microns

Copper ISC disk 25.4 microns



7/16" in Diameter

1/8" in Diameter

Anode Active Layer 41.7 microns



Anode Active Layer 41.7 microns

Patented

● Adhesive used to hold ISC together.

Other Types of ISC

Cathode Active layer 37.0 microns

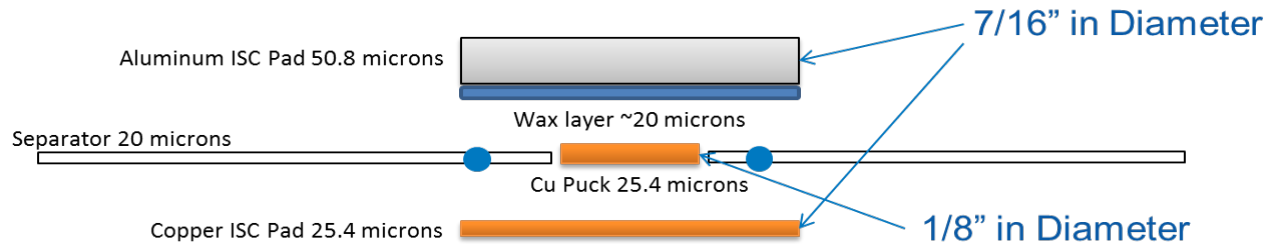
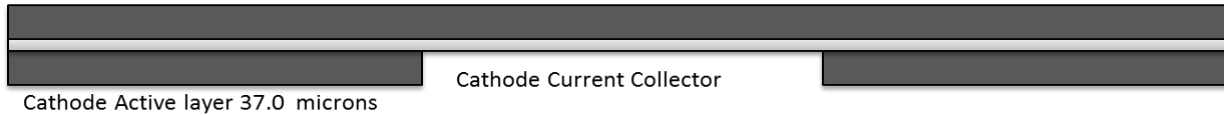

Anode Active Layer 41.7 microns

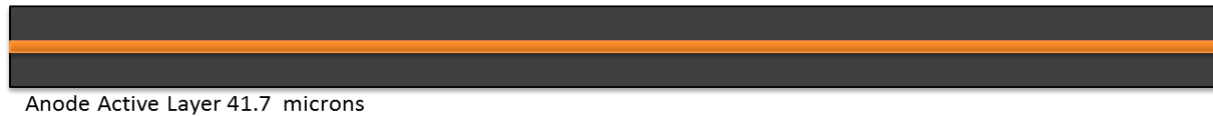

Collector to Collector ISC
Type 4

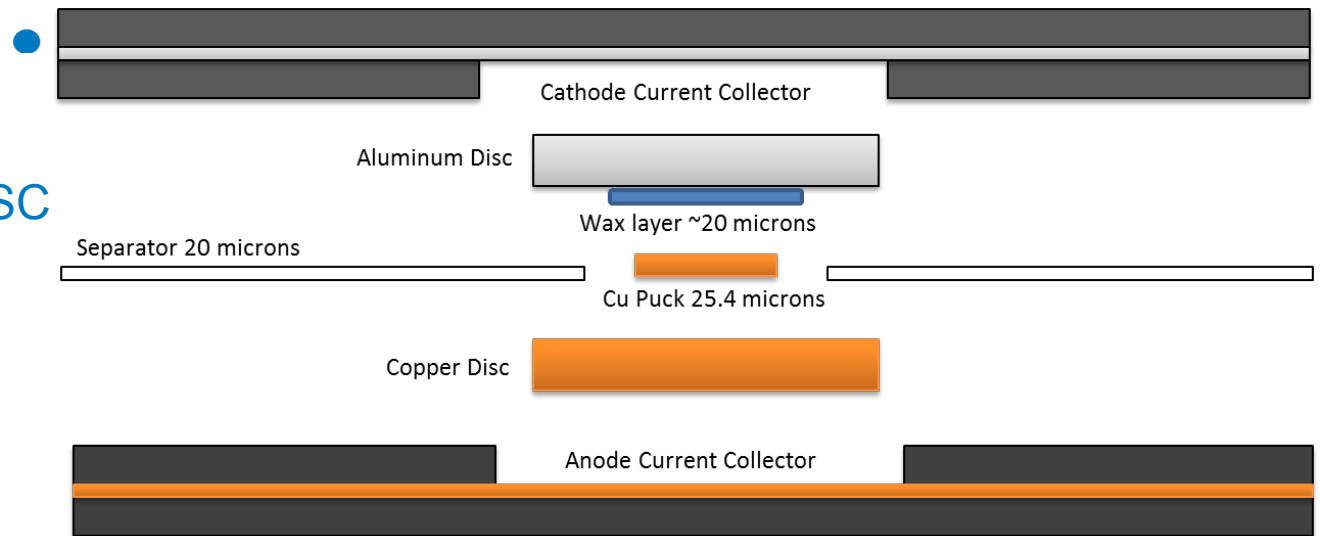

Testing Procedure for Cells with ISC Device

- NREL built ISC devices (in Golden, CO)
- Sent ISC device to E-one Moli (in Canada)
- E-one Moli implanted the ISC Device in 2.4Ah18650 Cylindrical Cell (NCA/graphite) during electrode winding
- E-one Moli assembled the cell and did formation
- Cell capacity did not change with ISC Device in them
- E-one Moli sent the modified cells to NASA (Houston, TX)
- NASA activated the ISC device by heating the cells to observe safety behavior

No Issues with Shipping of ISC Devices and Cells with ISC Device

ISC Implantation – in E-one Moli Cells 18650 NCA/graphite – 2.4 Ah

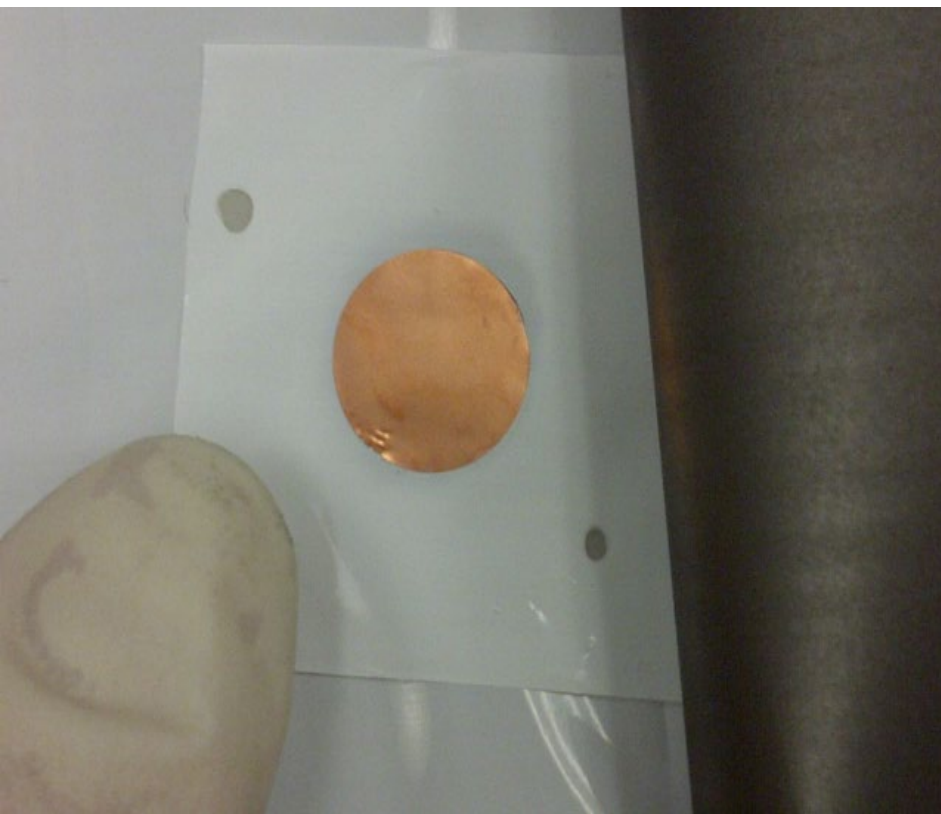
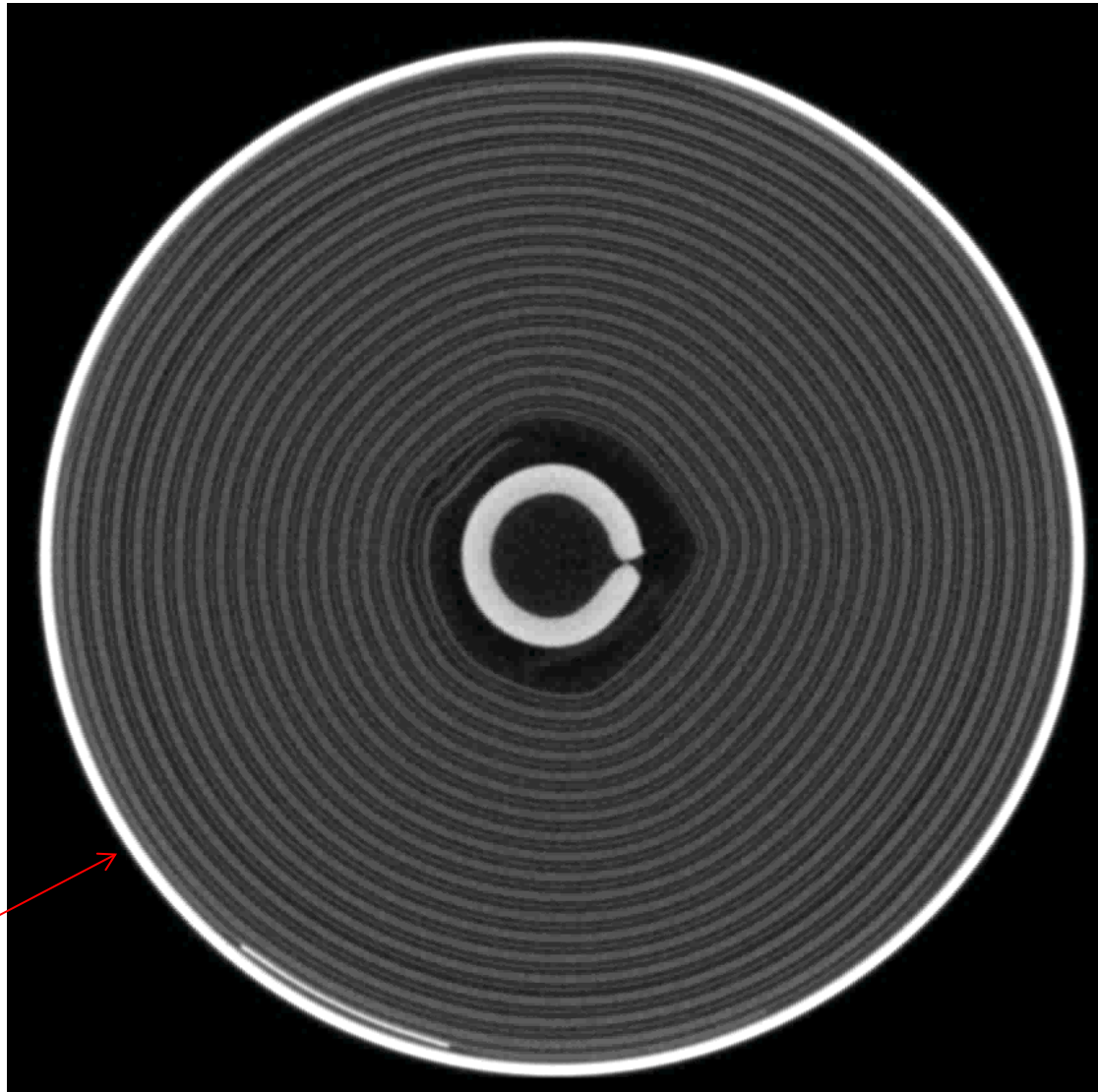

Photo Credits: Mark Shoesmith, E-One Moli

CT Scan of ISC in E-One Moli Cell

Click on Image to see video approximately 10 seconds into video the ISC will appear in the lower left hand corner of the cell.



ISC Device inserted

Photo Credits: Mark Shoesmith, E-One Moli

Type 2 (Al-Anode) Repeatability Study - 2014

Cell	Successful Formation	Successful Activation?	Thermal Runaway?
1	Yes	Yes	Yes
2	Yes	Yes	Yes
3	Yes	Yes	No
4	Yes	Yes	Yes
5	Yes	Yes	No
6	Yes	Yes	Yes
7	Yes	No	-
8	Yes	Yes	Yes
9	Yes	Yes	Yes
10	Yes	No	-

2 out of 10 ISCs did not activate (quality issues during fabrication)

6 out of 8 went to thermal runaway

Type 2 ISC – 75% Repeatable Results - 2014

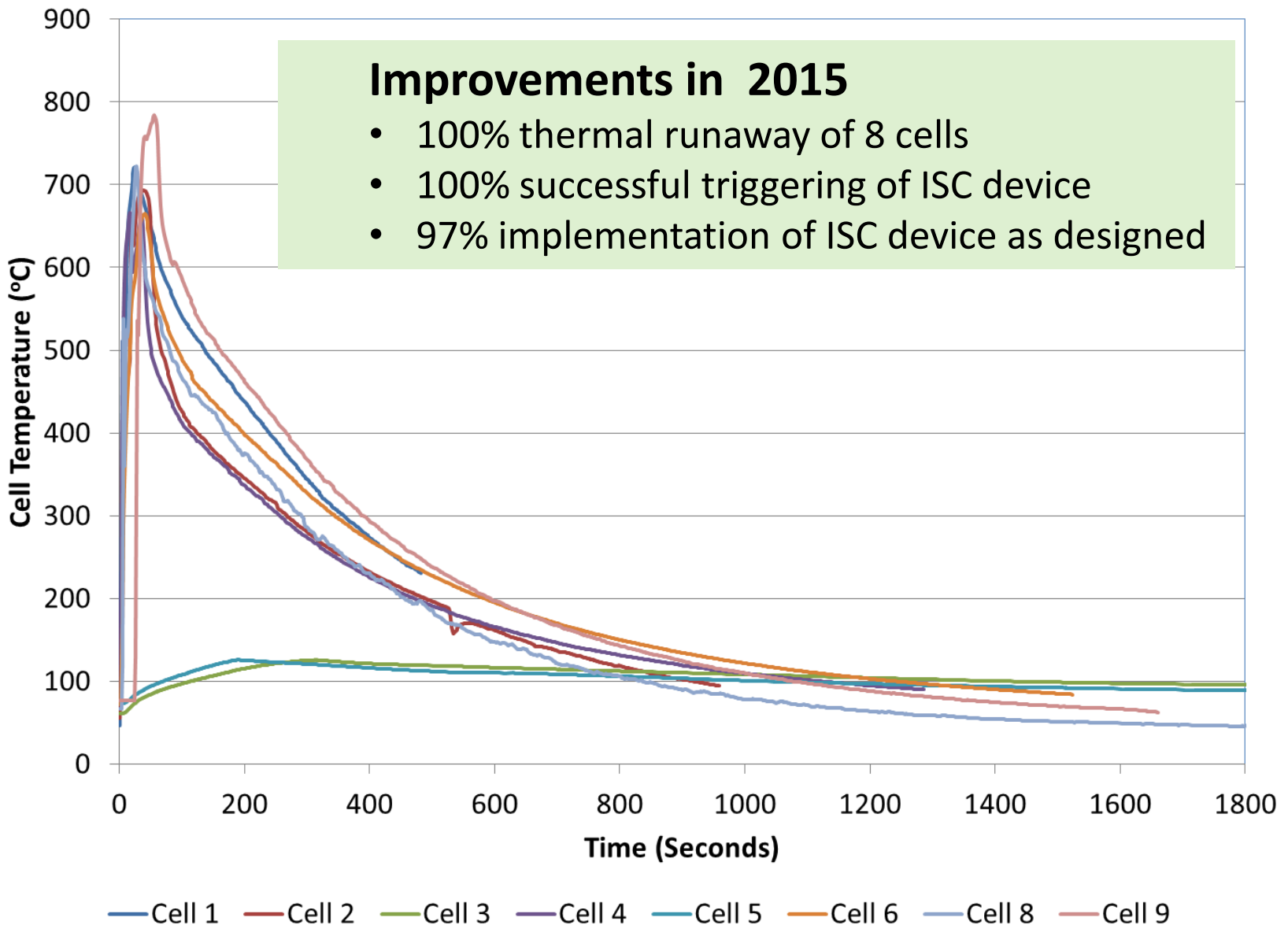

Al to Anode (2) ISC Activation

18650 Cell Activation – 100% SOC

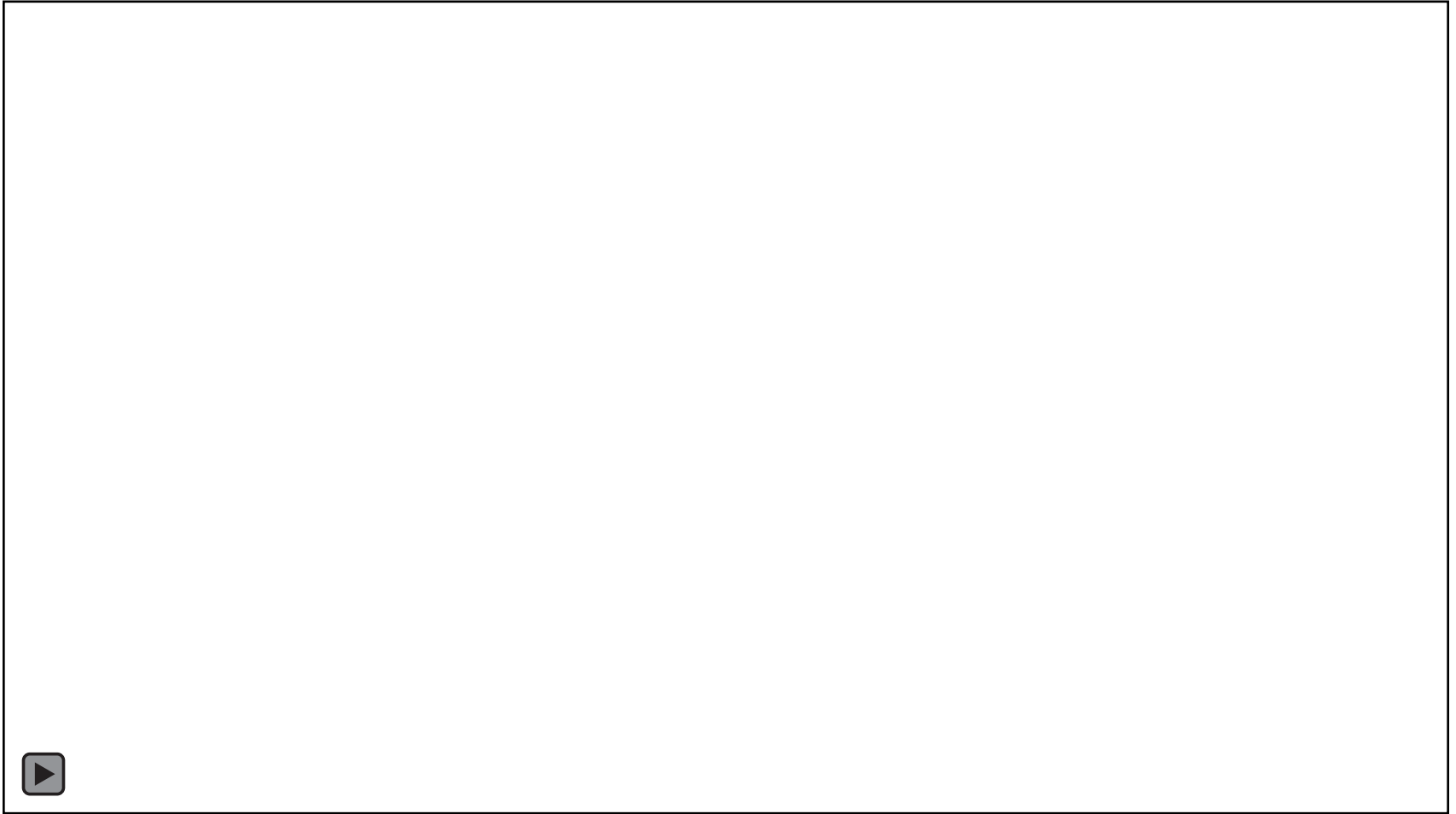

Photo Credit: Mark Shoesmith, E-One Moli

A Novel Li-ion Packaging Technology: High Energy, Low Cost, Safe



- **Cadenza's large prismatic cell technology for grid storage and PEV**

- Uses commoditized 26mm jelly rolls – “ease of supply”
- Proprietary housing material with thermal quenching ability developed by Morgan Advanced Materials
- Large cells ranging from 30Ah to 200Ah in development
- Low cost \$125/kWh
- Ability to survive internal short without cascading allows high energy density
- No expansion and contraction during cycling



110 Ah demo cell

- **US Department of Energy/ARPA-E Range Project Team**

- Cadenza Innovation LLC (Principal), Fiat Chrysler Automobiles, NREL, Samsung SDI NA, Morgan Advanced Materials, Magna Styer Battery Systems NA, Alcoa, Karotech LLC, and Impact Design LLC

Using NREL's ISC Device Has Shown Non-Cascading Feature of Cells

- **Intended application for ARPA-E project**
 - Fiat 500e (24kWh original battery)
 - DEMO battery project: 38kWh (in the same volume)
- **A Proof-of-concept cells to date**
 - Single row cell (Gen-0 cell): 30Ah (NCM) & 36Ah (NCA);
 - 23 x jellyroll array: 80Ah (NCM) & 90Ah (NCA)
 - 24 x jellyroll array: 110 Ah prototype cell currently in validation



110 Ah demo cell

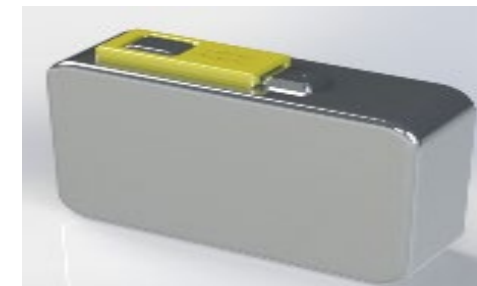

ISC Device in A 30Ah Gen-0 NCM Cell and a 90 Ah Gen-1 NCA

One Cell with internal short circuit device implanted jelly rolls

30Ah Gen-0 cell consisting of 6 x 5Ah NCM jelly rolls

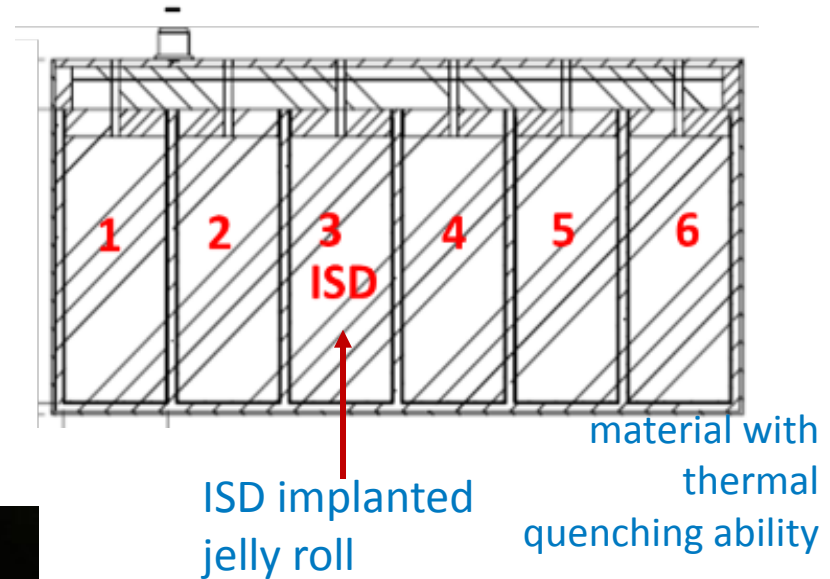
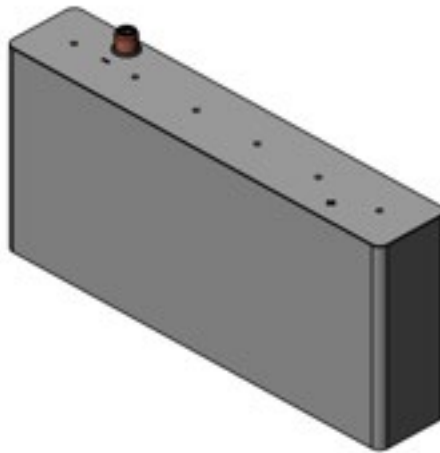

90 Ah Gen-1 cell consisting of 23 x 3.9Ah NCA jelly rolls

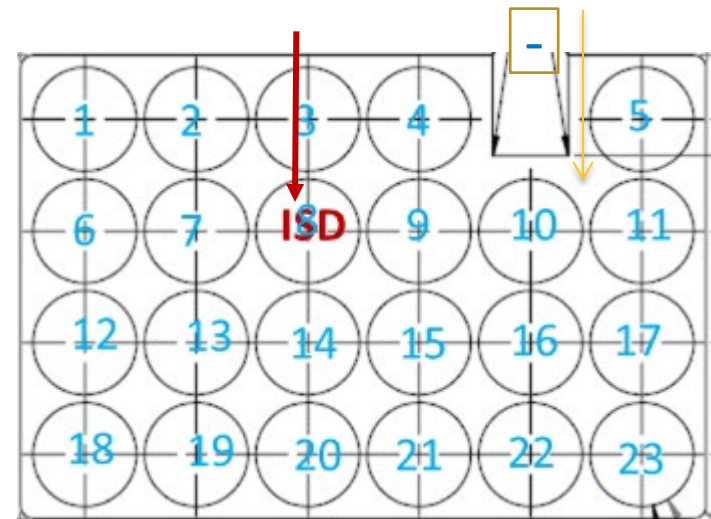
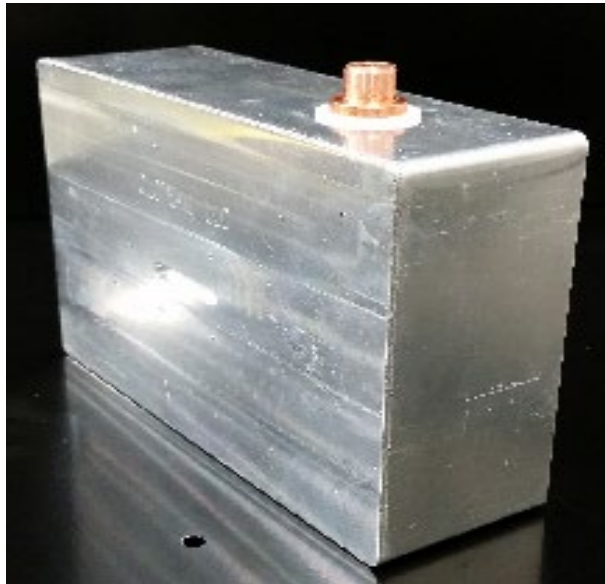

Modeled Thermal Behavior of Cell (ISC Triggered)

to see if housing material quenches a jelly roll under internal short

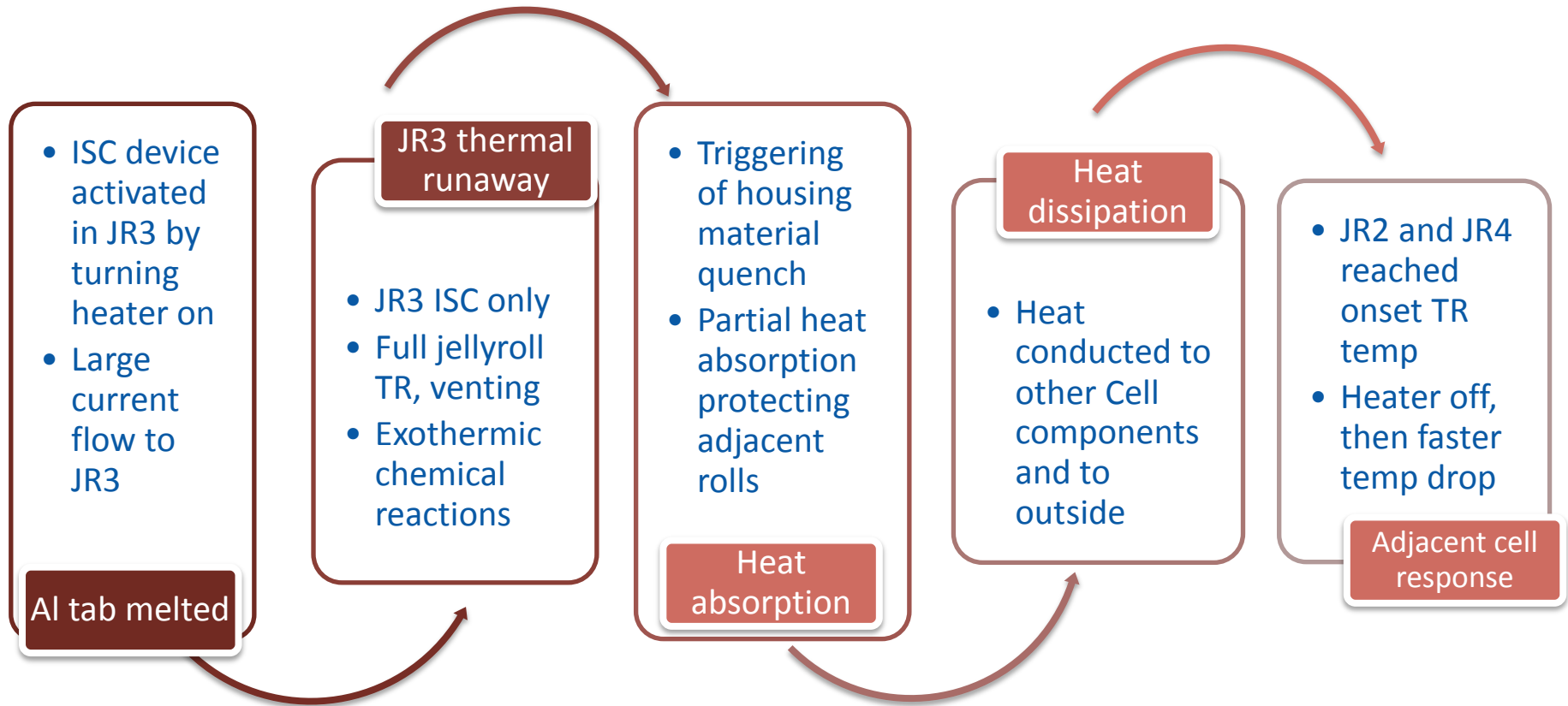

ARC Testing – TR Heat Measurement for Model



**NREL's THT EV
Accelerating Rate
Calorimeter**



**3 Ah jelly roll rapid thermal runaway (>10°C/min)
occurs 20°C lower than 2.2 Ah cell**

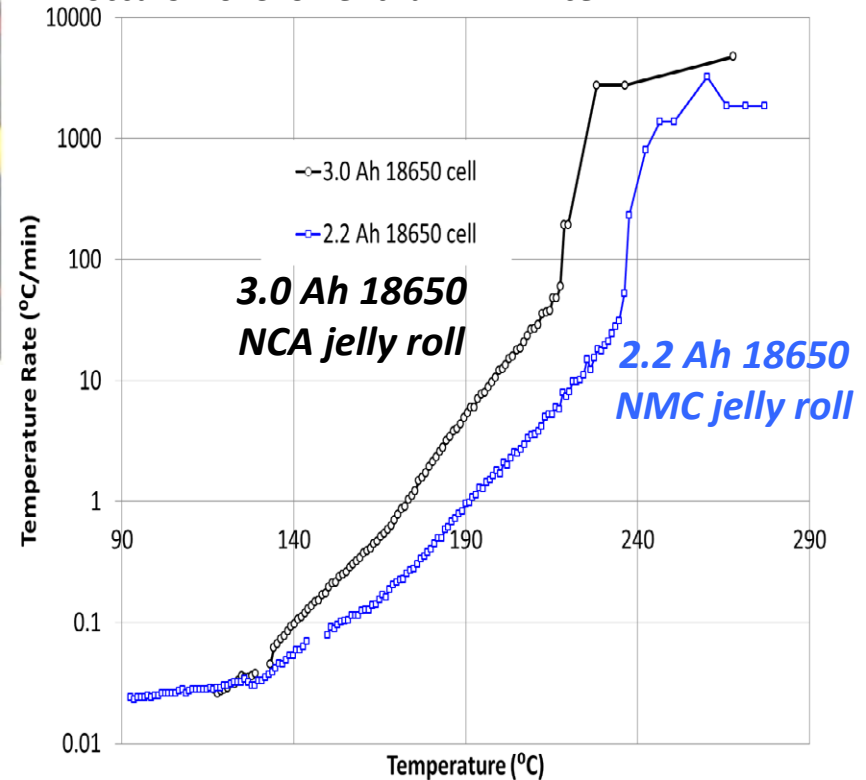

Jelly Roll	Weight (g)	Onset Temp (°C)	Peak Temp(°C)	Venting Temp(°C)	Total Heat Generation (J)	Runaway Enthalpy(kJ/Ah)	Mass Change (g)
18650 3.0 Ah	45.23	111.6	932.4	128.0	31,002.91	10.33	13.27 (29.3%)
18650 2.2 Ah	43.34	91.5	782.7	143.7	25,016.76	11.37	8.97 (20.1%)

Thermal Modeling Showed TR Was Not Cascaded

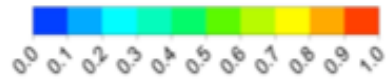

Quenching – phase 1

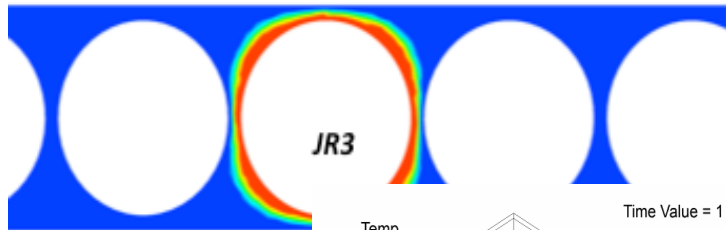

JR3

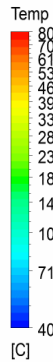

Time Value = 1 [s]

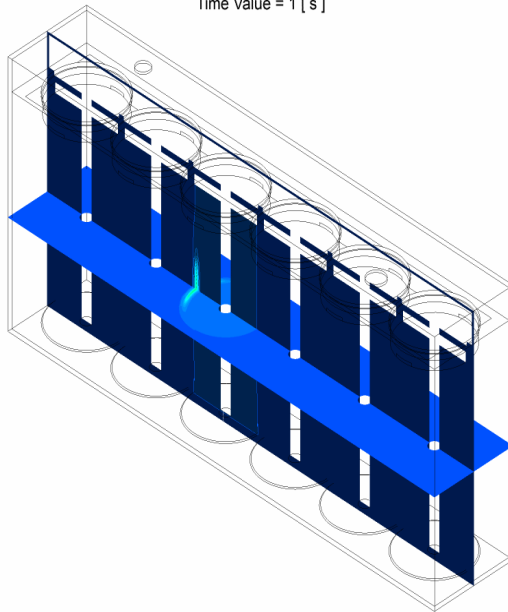

ANSYS
R15.0

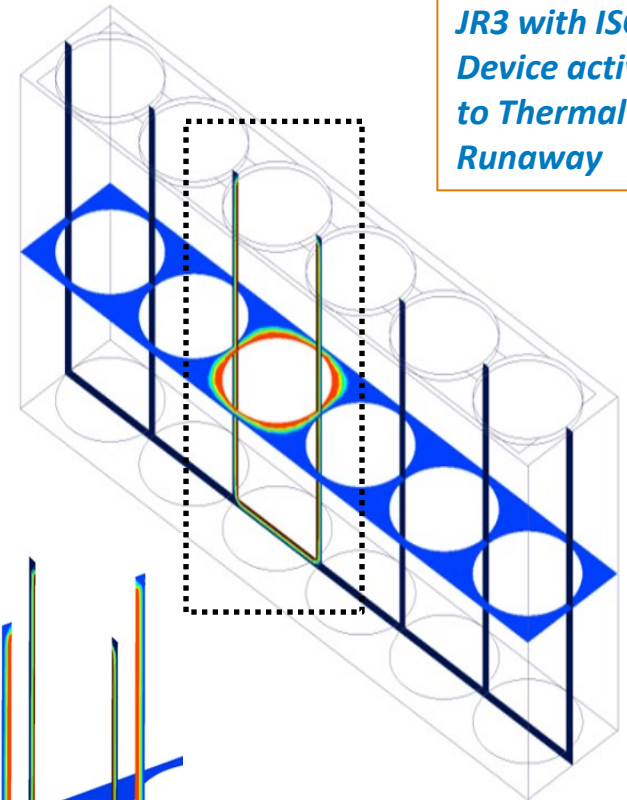
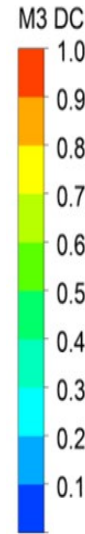

JR3 with ISC
Device activated
to Thermal
Runaway

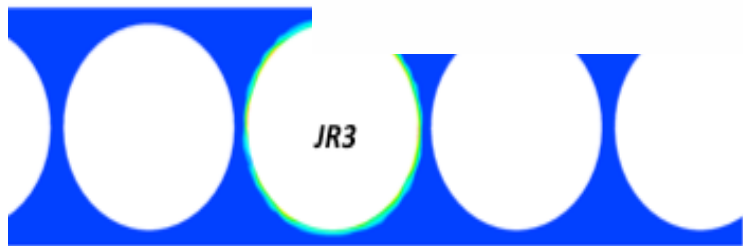
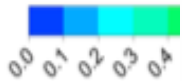

JR3

Quenching – phase 2

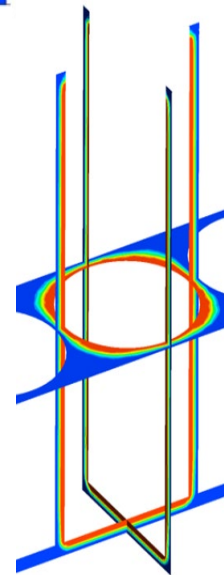

Uniform heat
absorption by
quenching
material

Experiments Showed No Cascading TR

for 30Ah Gen-0 NCM cell after initiating the ISC Device

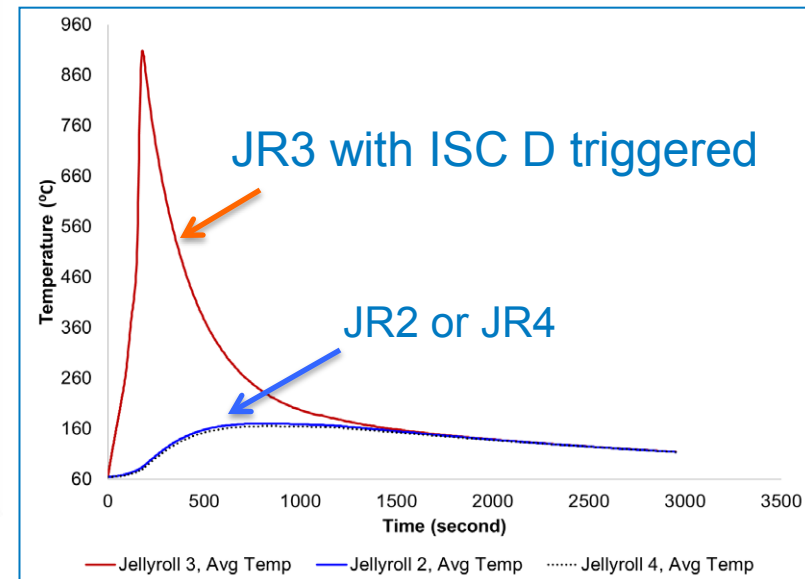
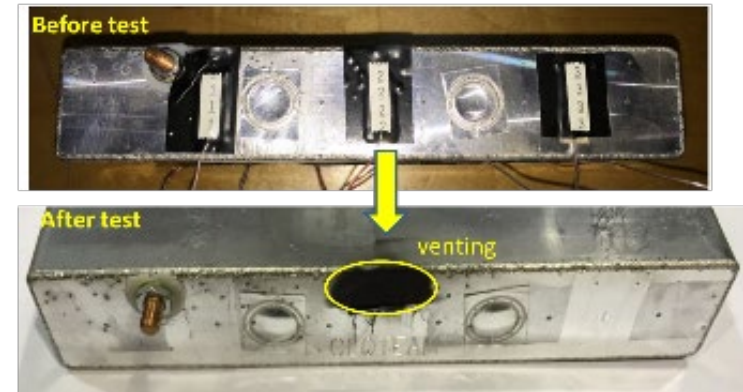
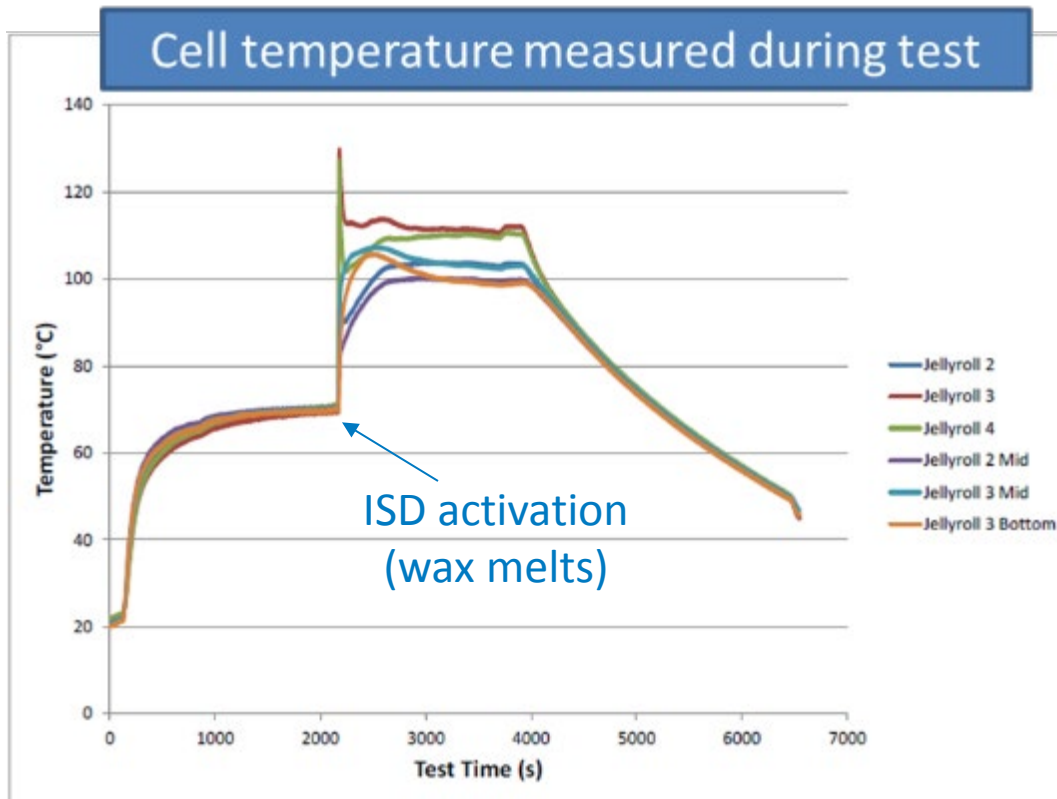

The cell only vented with a max measured cell surface temperature less than 138°C.

Experiments Showed No Cascading TR

in the 90 Ah (NCA) cell after initiating the ISC Device

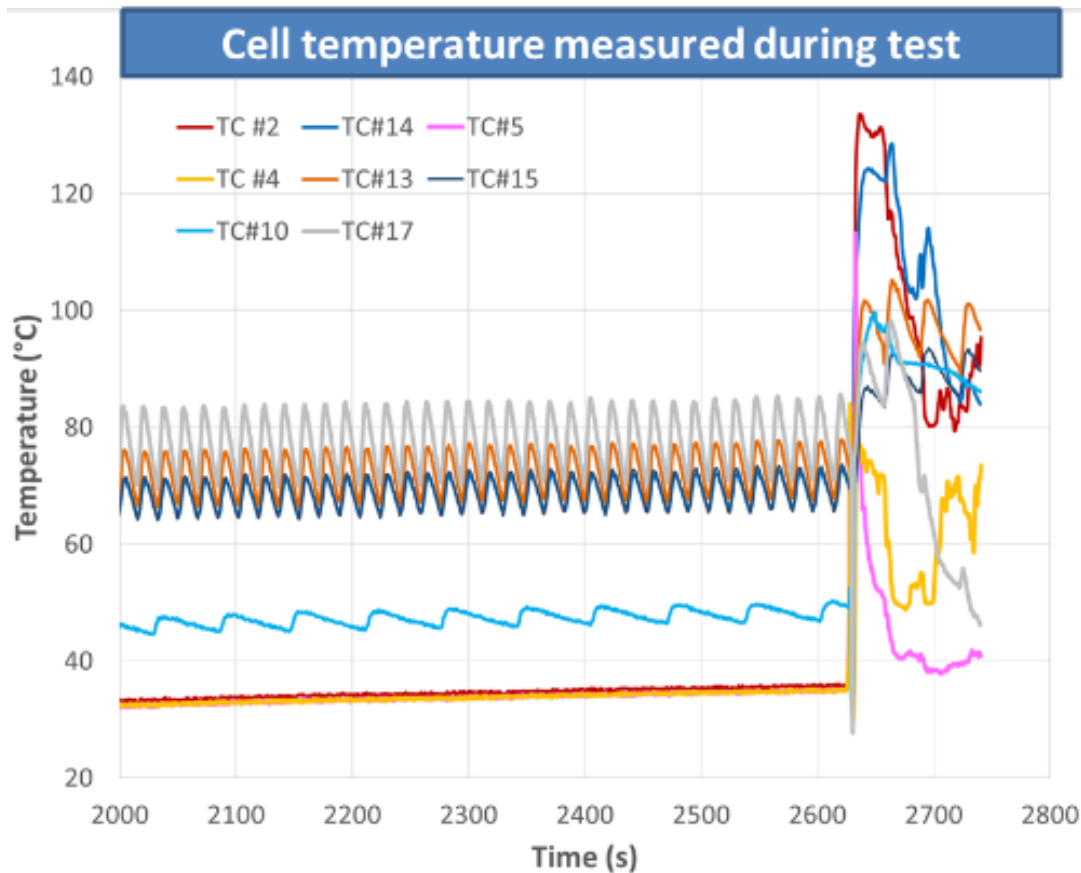

Front of cell after test

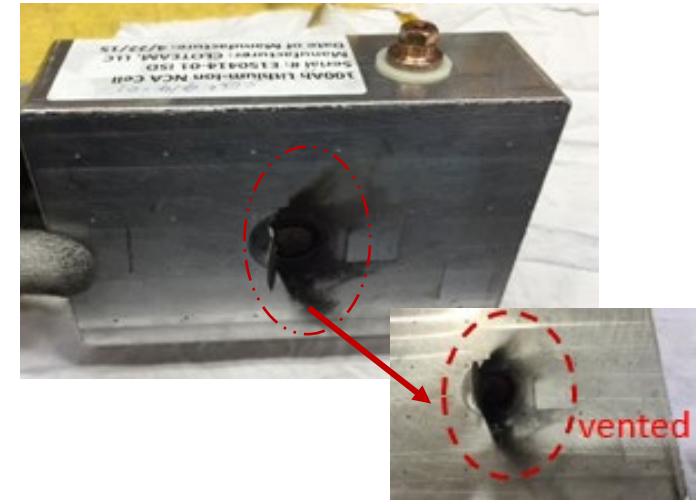

The cell only vented with a max measured cell surface temperature less than 138°C.

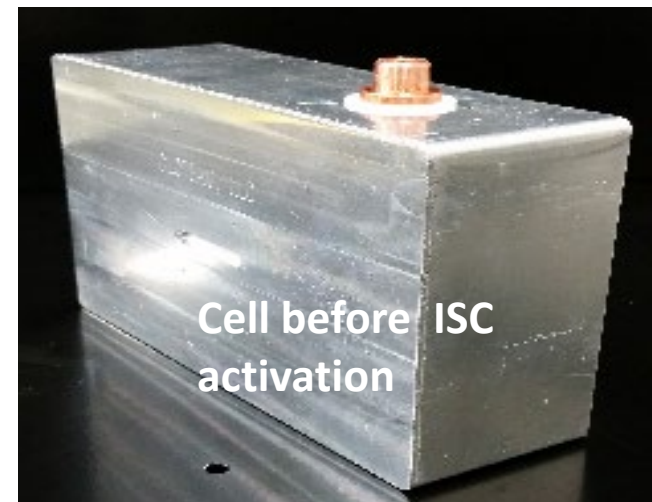

Summary

- **NREL has a portfolio of battery safety modeling to evaluate battery design ideas and propose safer designs**
- **NREL has developed an ISC Device to emulate internal short circuits in any cell format for four types of shorts**
- **ISC device is a research tool; repeatable and with consistent results**
 - Must be implanted when prototyping cells
 - Not suitable for post-production cells
 - Can be used for cell-to-cell thermal runaway propagation study
- **Our modeling showed non-cascading feature of a new cell uniquely packaged by Cadenza Innovation and ISC device has proven its safety**
- **NREL Battery ISC Device is available for use by new collaborators**

Thank You!

<http://www.nrel.gov/transportation/energystorage/>

- Funding for ISC Device and Model Development provided by DOE Vehicle Technologies Office

- Funding for project with Cadenza Innovation provided by DOE ARPA-E RANGE Program

- Appreciate the support and contributions by Cadenza Innovation

