

Thermal Performance Benchmarking



Gilbert Moreno
National Renewable Energy Laboratory

2015 Annual Merit Review and Peer Evaluation
Washington, D.C.
June 9, 2015

Project ID: EDT070

This presentation does not contain any proprietary, confidential, or otherwise restricted information.

Overview

Timeline

- **Project start date:** FY15
- **Project end date:** FY17
- **Percent complete:** 15%

Budget

- **Total project funding:** \$200K
 - DOE share: \$200K
- **Funding for FY15:** \$200K

Barriers

- **Weight**
- **Performance and Lifetime**
- **Efficiency**

Partners

- **Oak Ridge National Laboratory (ORNL)**
- **Argonne National Laboratory (ANL)**
- **National Renewable Energy Laboratory (NREL) – Project Lead**

Relevance: Objectives

Overall objective: To benchmark the thermal characteristics of the power electronics and electric motor thermal management systems

- Understand the current state-of-the-art (SOA) in thermal management systems and develop methods to improve on the SOA

FY15 objective: Evaluate the thermal management systems for the 2014 Honda Accord power electronics and the 2012 Nissan Leaf power electronics and electric motor

Relevance: Impact

The information collected from these benchmarking activities will:

- Evaluate advantages and disadvantages of different thermal management systems
- Identify areas of improvement to advance the SOA
- Establish baseline metrics for the thermal management systems
- Increase the publicly available information related to automotive traction-drive thermal management systems
- Help guide future Electric Drive Technologies (EDT) R&D efforts
- Help industry to reduce the weight, volume, and cost of vehicle traction-drive systems by providing information that may influence future product designs
- Determine the operating temperatures for the EDT components in real-world operation.

Milestones

Month/ Year	Milestone or Go/No-Go Decision	Status
December 2014	Milestone: Draft the test plan for characterizing the thermal performance for both the inverter and electric motor.	Met
March 2015	Milestone: Modify the test loops (e.g., water-ethylene glycol [WEG] loop, automatic transmission fluid test loops) to accommodate the inverter and electric motor. Design and fabricate parts as required.	Met
June 2015	Milestone: Calibrate the various sensors (e.g., thermocouples, pressure transducers). Instrument the test articles (e.g., power module in the inverter) with temperature and pressure sensors for the experiments.	In progress
September 2015	Milestone: Complete thermal characterization of a commercially-available inverter and electric motor and summarize results in a report.	Upcoming
September 2015	Go/No-Go: Make a decision on the future power electronics and electric motor systems to be benchmarked.	Upcoming

Approach/Strategy

Collaborate with industry and ORNL to identify the vehicle system to benchmark



Acquire the vehicle components



Measure the characteristics of the thermal management systems

- Experimentally measure thermal performance metrics
 - Utilize modeling, particle image velocimetry, high speed video, and infrared imaging to understand heat transfer mechanisms
- 

Analyze the data and calculate thermal performance metrics



Share results with industry and research institutions

Approach/Strategy: Thermal Measurements

Electric motor thermal management

- Winding-to-liquid thermal resistance
- Motor lamination and winding thermal properties
- Pressure drop through the heat exchanger
- Volume and weight of the heat exchanger

Power electronics thermal management

- Junction-to-liquid thermal resistance
- Interface material thermal resistance
- Capacitor thermal properties
- Thermal resistance and pressure drop through the heat exchanger
- Volume and weight of the heat exchanger

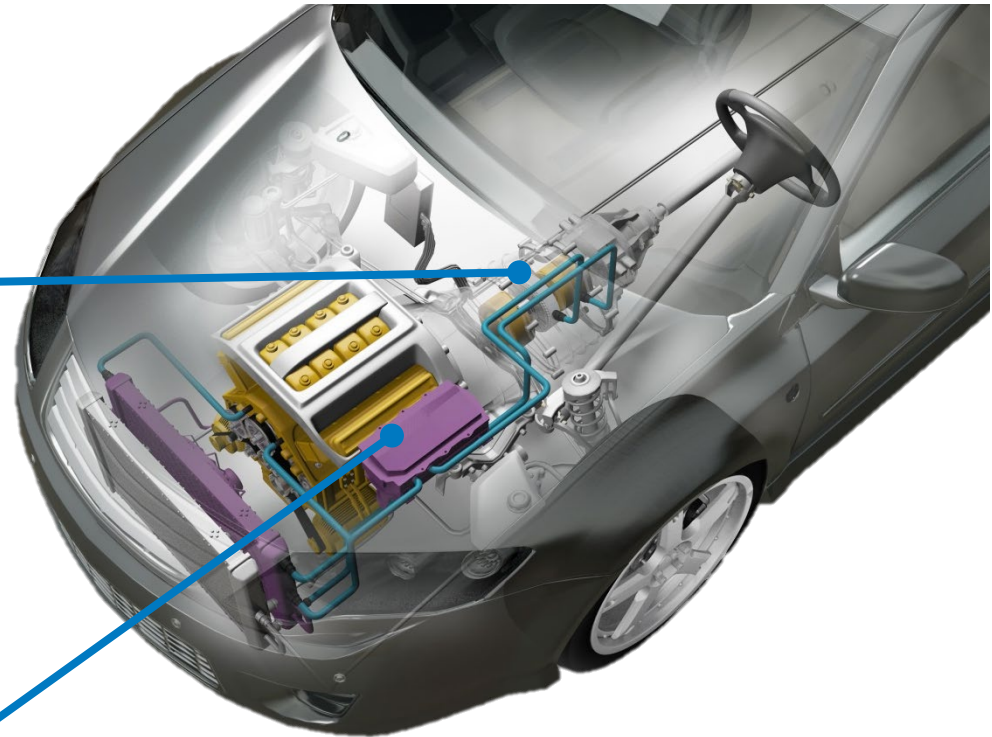

Thermal management components

- Pump pressure versus flow rate characteristics and efficiency

Approach/Strategy: Assumptions

- The experiments are designed to measure the performance of the motor and power electronic thermal management systems. This requires test procedures to accurately measure the heat dissipated by the components and the component temperatures. These test procedures do not replicate automotive environments or operating conditions. Strategies to improve thermal performance can then be deduced from these tests.

Approach/Strategy: FY15 Schedule

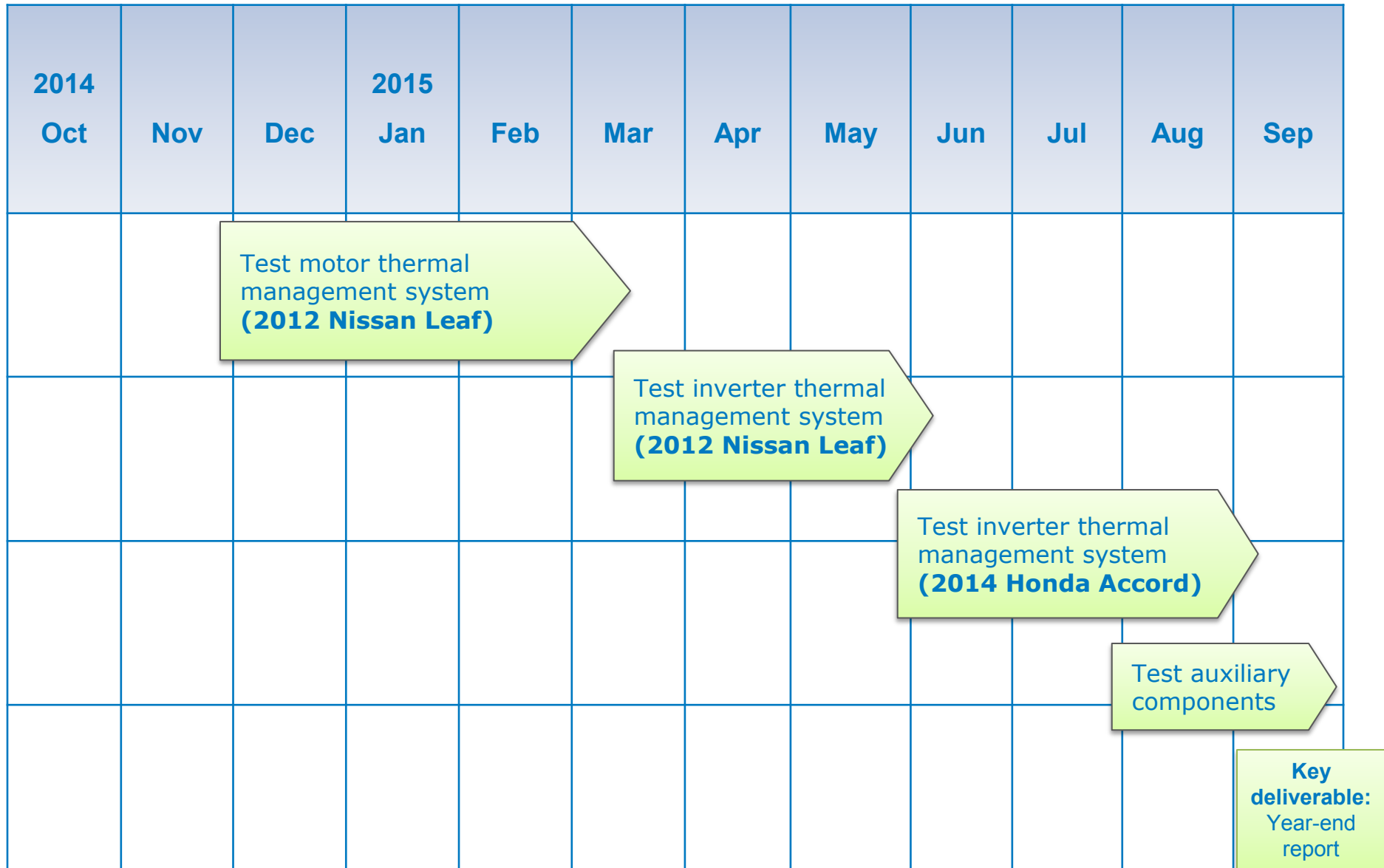

Technical Accomplishments: Motor Thermal Management System

- Cast aluminum cooling jacket pressed around the stator
- WEG circulated through three cooling channels within the cooling jacket

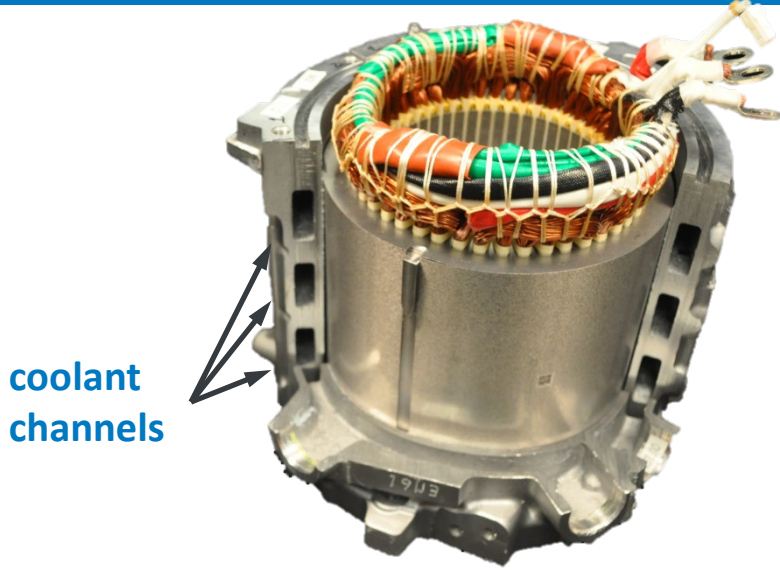

(Credit: Kevin Bennion, NREL)

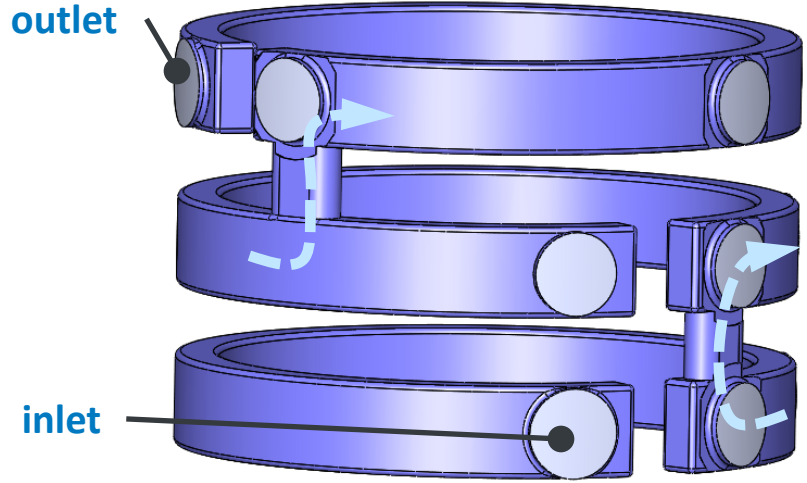

View of the cooling channels showing the WEG flow path

Technical Accomplishments: Test Procedures

- Connected the motor to the WEG test bench
- Circulated WEG (50/50) at 65°C through the cooling jacket at different flow rates [2, 4, 8, 10, and 12 liters per minute (lpm)]
- Heated the windings by running a high current (low voltage) through all phases
- Measured the motor temperature at various locations using thermocouples.

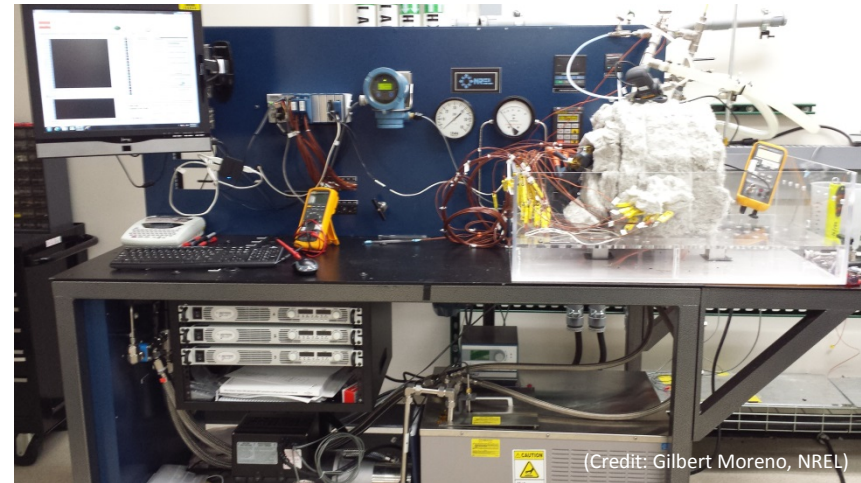

Motor (with insulation) connected to the WEG test bench

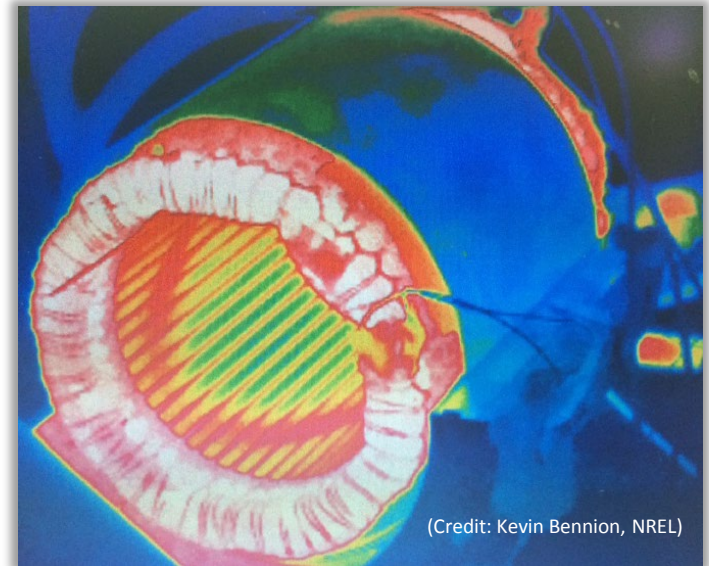

Thermal image of motor with all phases heated

Technical Accomplishments: Instrumented the Motor

Instrumented the motor with 40 thermocouples to measure temperatures and compute thermal resistances at various locations on the motor:

- Installed 20 thermocouples on end-winding surfaces
- Installed 10 thermocouples on the stator and slot liner
- Installed 10 thermocouples on the cooling jacket.

Technical Accomplishments: Instrumented the Motor

Installed 20 thermocouples on end-winding surfaces

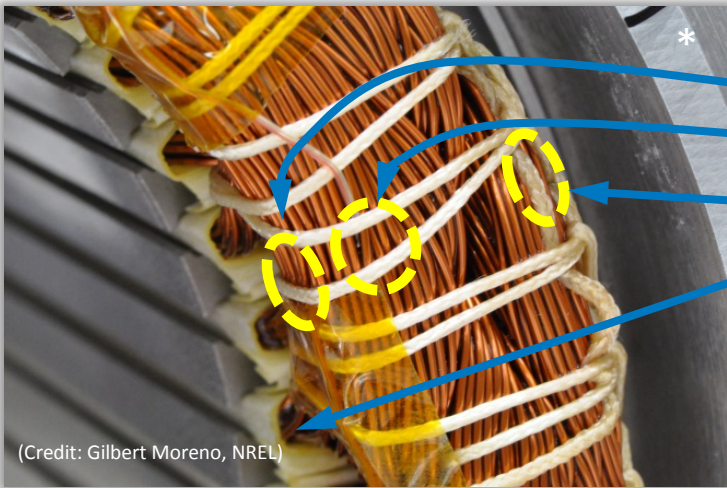

(Credit: Gilbert Moreno, NREL)

Thermocouples were installed on

- inside-winding surface
- top-winding surface
- outside-winding surface
- between end-winding and slot liner.

**Note: Image shows thermocouples prior to being bonded to the motor with thermally-conductive epoxy*

Thermocouples were installed at three locations equally spaced on the end windings (both sides).

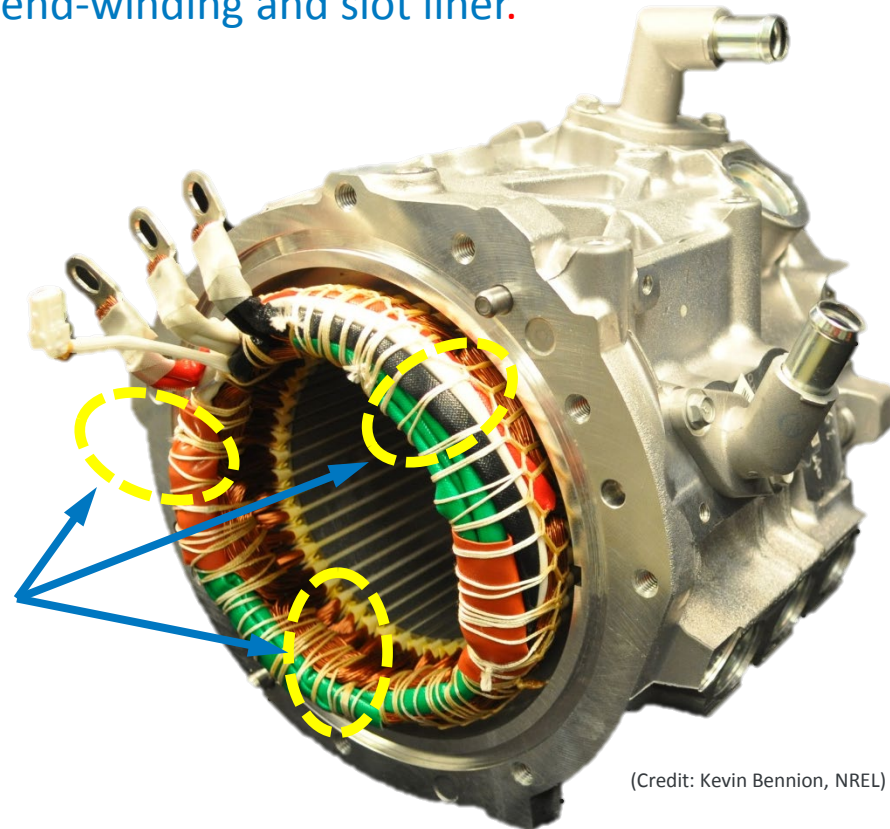

(Credit: Kevin Bennion, NREL)

Technical Accomplishments: Instrumented the Motor

Installed 10 thermocouples on the stator and slot-winding surfaces

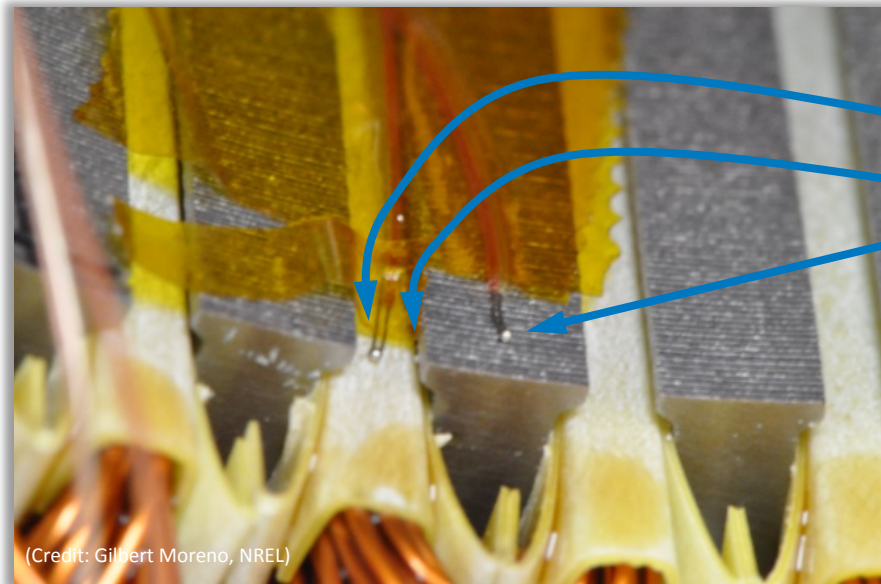

(Credit: Gilbert Moreno, NREL)

**Note: Image shows thermocouples prior to being bonded to the motor with thermally-conductive epoxy*

Thermocouples were installed on

- Slot-liner surface
- Between stator lamination and slot liner
- Stator-lamination inside surface.

Thermocouples were installed on both sides and midpoint of the motor to evaluate temperature variations in the axial direction.

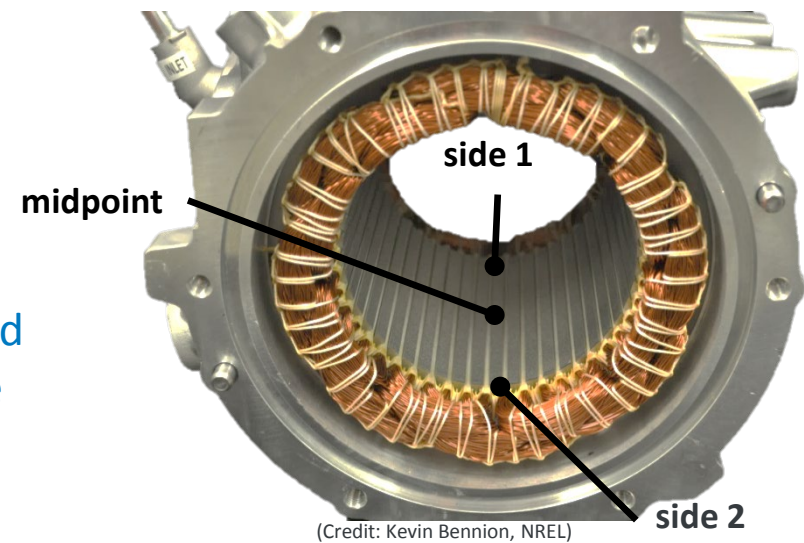

(Credit: Kevin Bennion, NREL)

Technical Accomplishments: Instrumented the Motor

Installed 10 thermocouples on the cooling jacket

Thermocouples installed on (bullet numbers coincide with numbers in figure below)

1. Drain ports and on the inlet and outlet (WEG temperatures)
2. Midpoint between coolant channels
3. Stator and cooling jacket interface
4. Cooling jacket, 2 mm above stator surface.

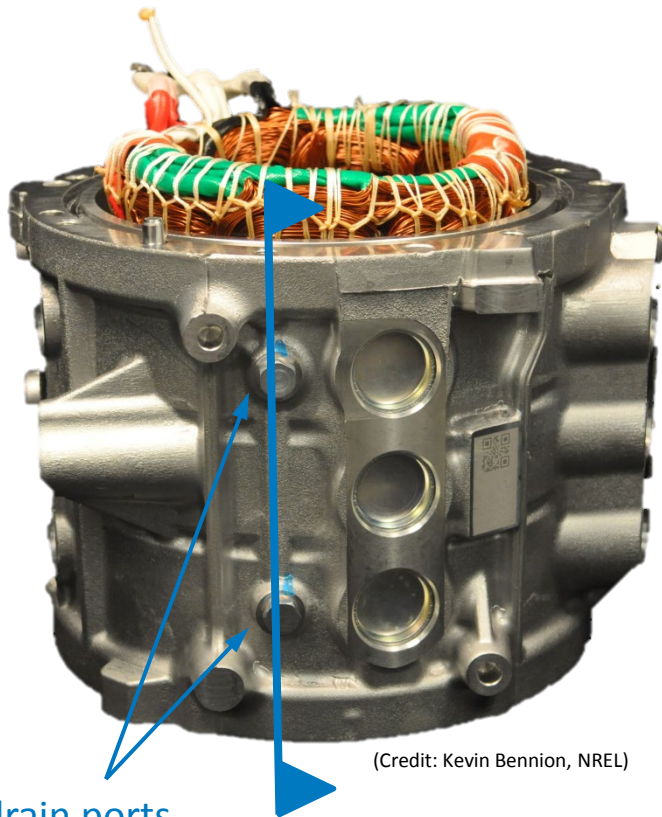

drain ports

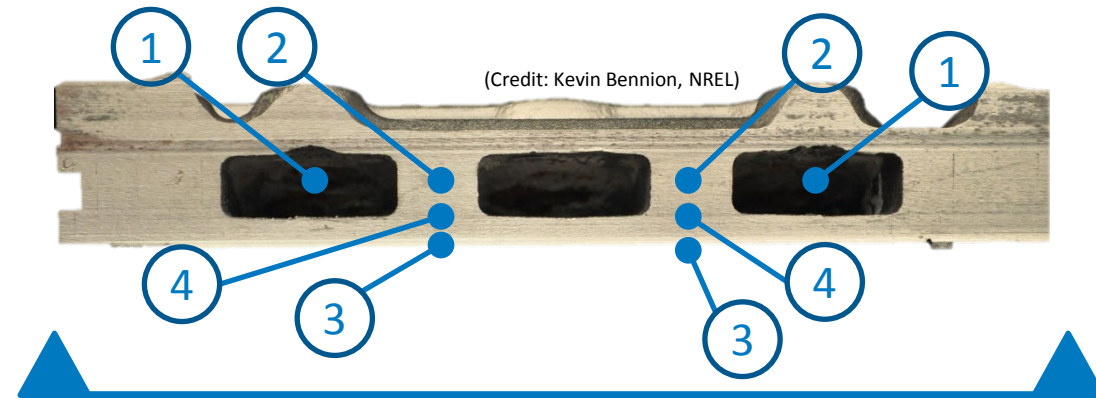

Cross-sectional view of the cooling jacket

Technical Accomplishments: Energy Balance

- Confirmed that the majority of the heat is absorbed by the WEG via the cooling jacket
- Used the heat absorbed by the WEG for the thermal resistance calculations.

$$Q = \dot{m} C_p (T_{out} - T_{in})$$

\dot{m} = mass flow rate

C_p = specific heat

Q = heat

T_{out} = outlet WEG temperature

T_{in} = inlet WEG temperature

WEG flow rate	Total heat input	Heat absorbed by WEG	Percent of total heat absorbed by WEG
lpm	watts	watts	%
1.8	564.7	508.8	90.1%
4.0	565.6	529.9	93.7%
8.1	566.8	536.9	94.7%
10.0	567.8	543.0	95.6%
12.0	567.3	542.4	95.6%

Technical Accomplishments: End-Winding Thermal Resistance

- Higher thermal resistance on the electrical-connection side (*side 1*) of the motor is a result of the heat generated by the electrical cables.
- Increasing the WEG flow rates has minimal effect on the thermal resistances. This behavior indicates that the passive stack thermal resistance is significantly greater than the convective thermal resistance.
- The high passive stack thermal resistance means that increasing the WEG flow rates beyond ~4 lpm has minimal effect on decreasing the thermal resistances. Improving the thermal performance of this WEG-cooled motor requires a significant reduction in the motor passive stack thermal resistance.

$$R_{th} = \frac{(T_{windings} - \overline{T_{WEG}})}{\text{total heat dissipated}}$$

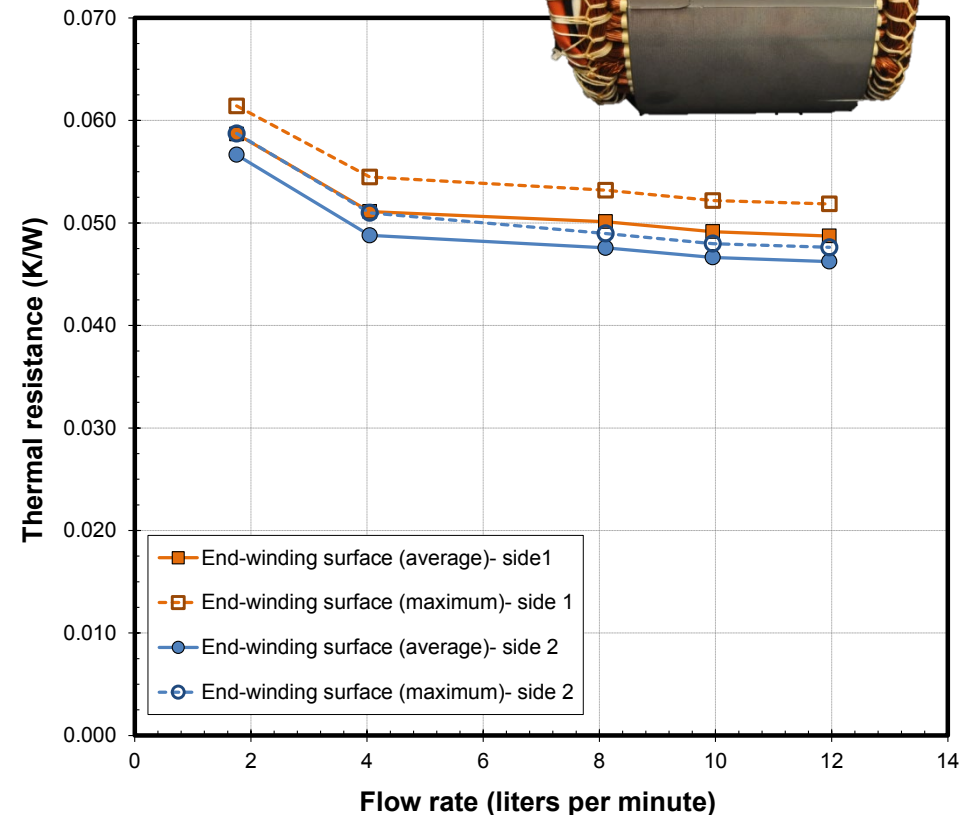
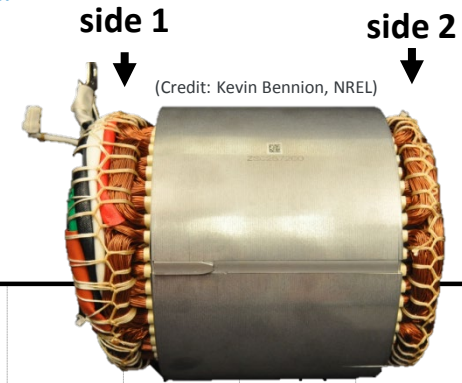

Technical Accomplishments: End-Winding Thermal Resistance

- Scaled the thermal resistances by the stator-to-cooling jacket contact area. Scaling the thermal resistances provides a metric that can be used when comparing the thermal performance of different motors
- The thermal resistance curve asymptotic lines indicate the point when $R_{th, passive\ stack} \gg R_{th, convective}$. Therefore, the thermal resistance asymptote lines can be used to estimate the passive stack thermal resistances.

$$R''_{th} = \frac{(T_{windings} - \overline{T_{WEG}})}{total\ heat\ dissipated} \times Area$$

Area = stator-to-cooling jacket contact area

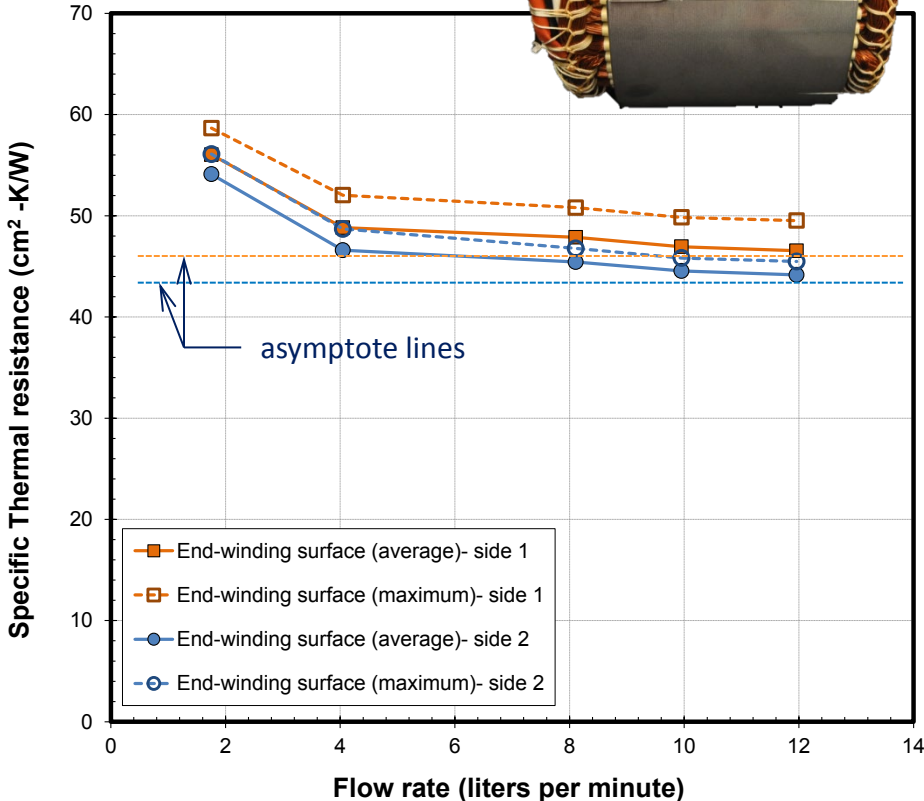
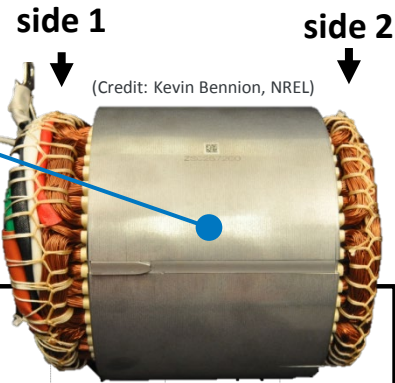

Technical Accomplishments: Stator Thermal Resistance

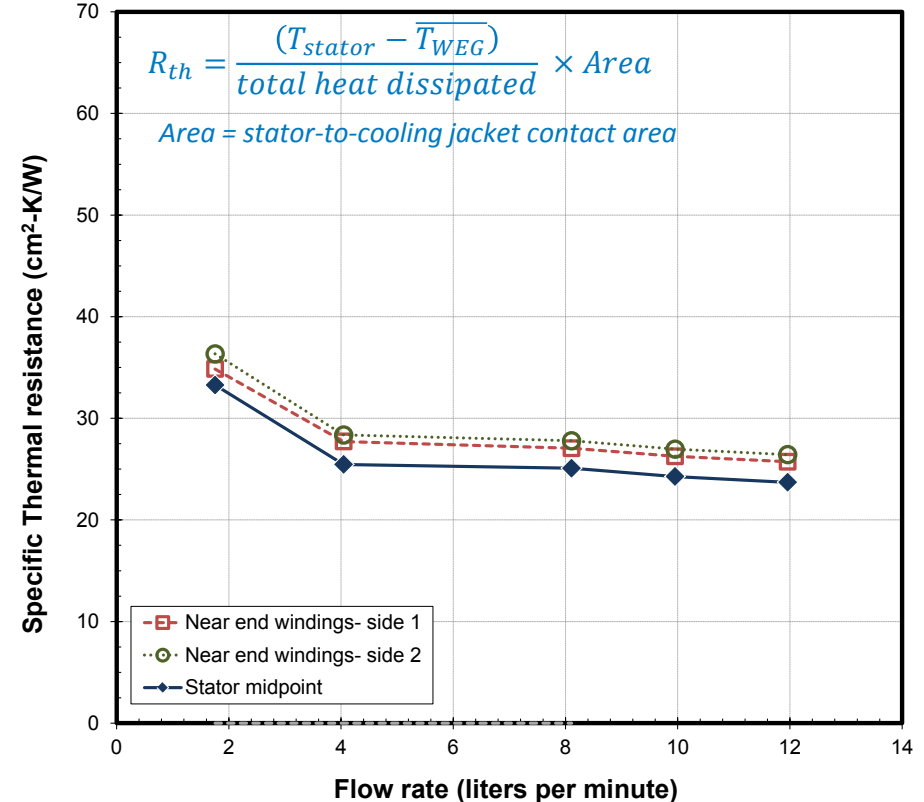
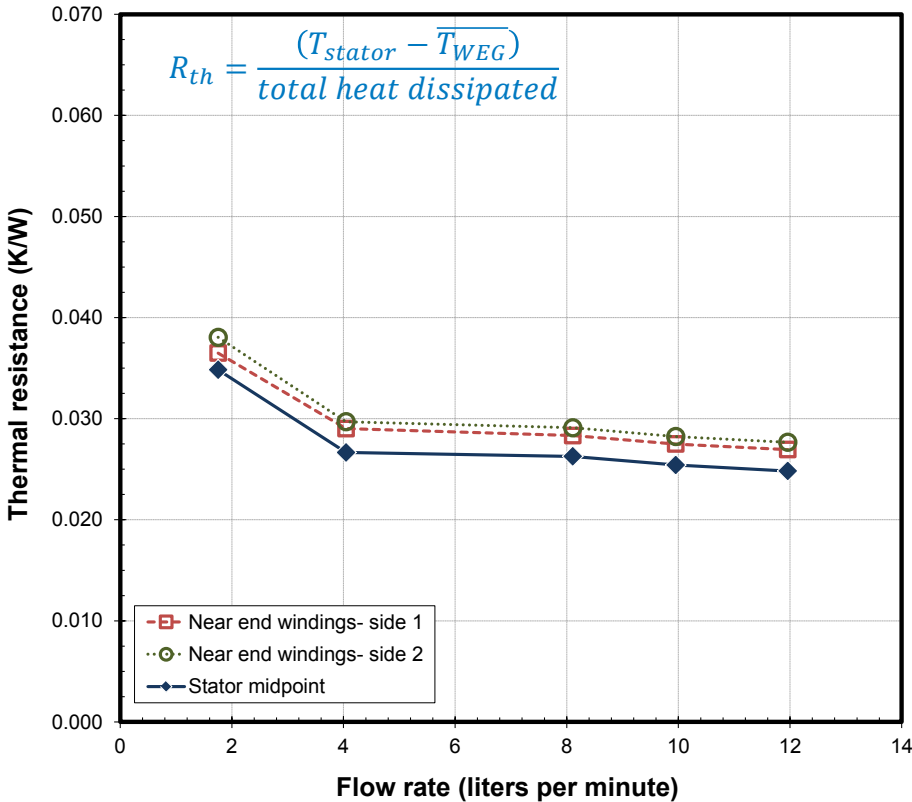

- Stator-to-liquid thermal resistances are essentially equal on both sides of the motor and are lowest at the motor midpoint
- Stator-to-liquid thermal resistances are lower than the winding-to-liquid (previous slides) thermal resistances. This effect is the results of a shorter heat-flow path from the inside of the stator to the coolant.

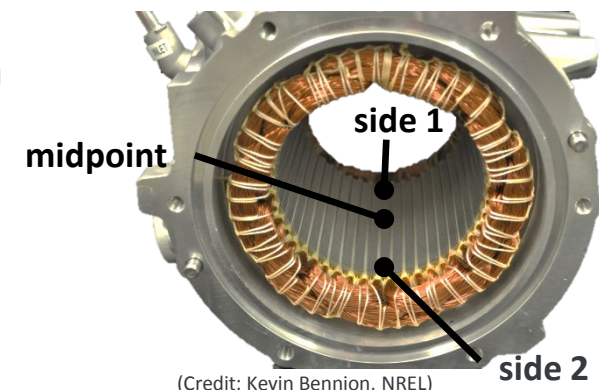

Technical Accomplishments: Pressure Drop and Parasitic Power

- Measured the pressure drop and computed the parasitic power through the cooling jacket
- Parasitic power will be used to compute the system efficiency (e.g., coefficient of performance) metrics.

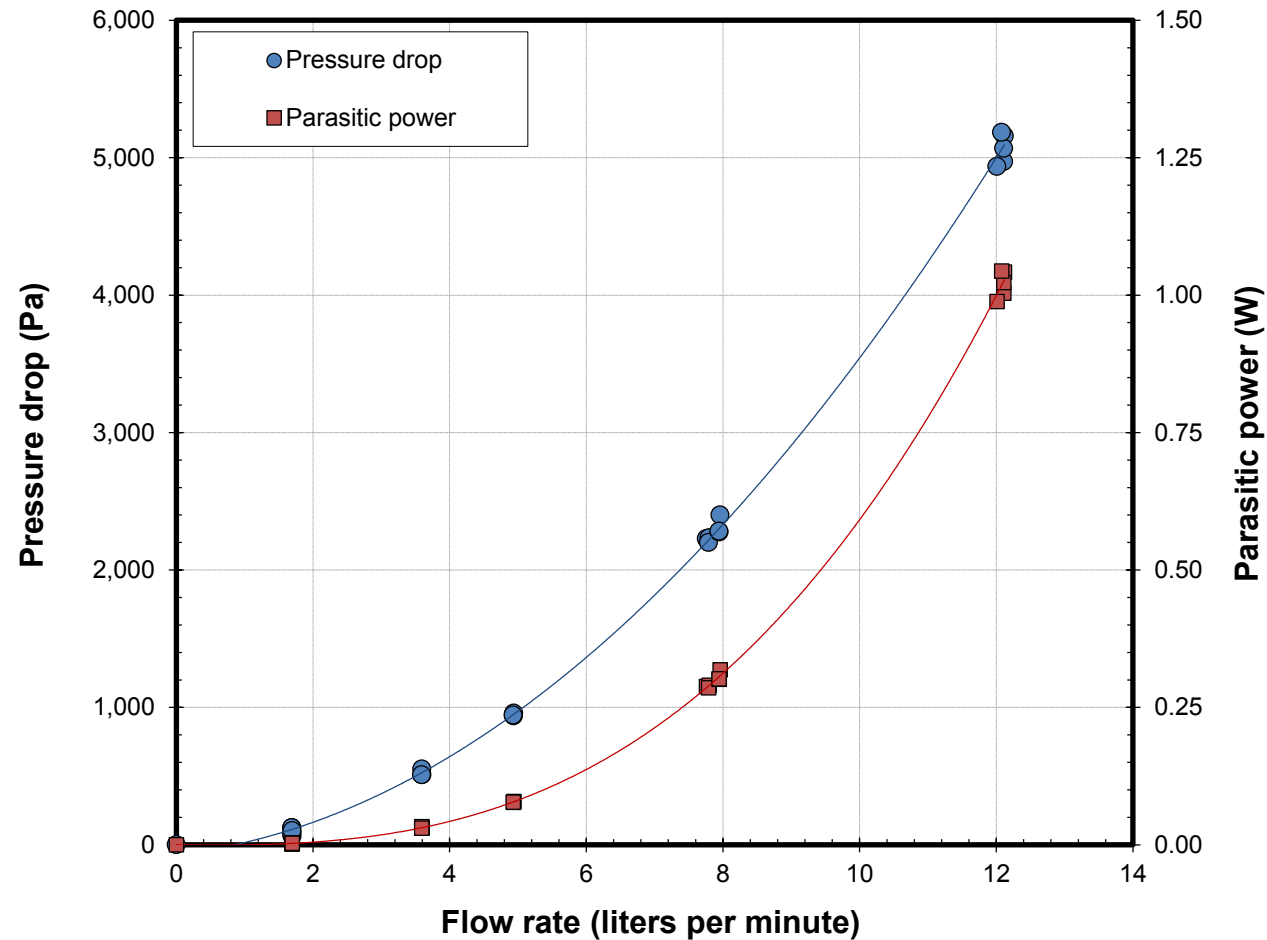

Technical Accomplishments: Motor CAD Drawing

- Generated computer-aided design (CAD) drawings of the motor
- Used for finite element (FE) and computational fluid dynamics (CFD) simulations
- FE and CFD analysis combined with experimental results will allow us to quantify the various thermal resistances within the motor (e.g., cooling jacket thermal resistance)

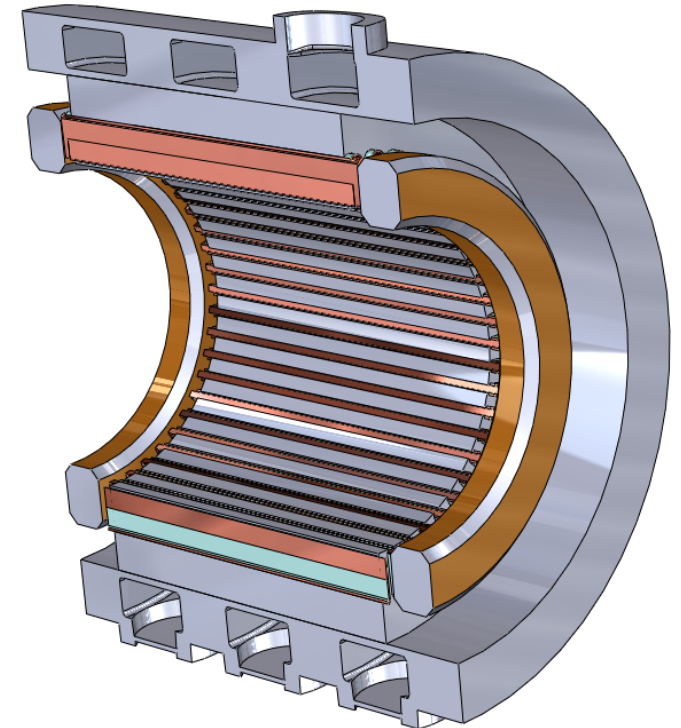
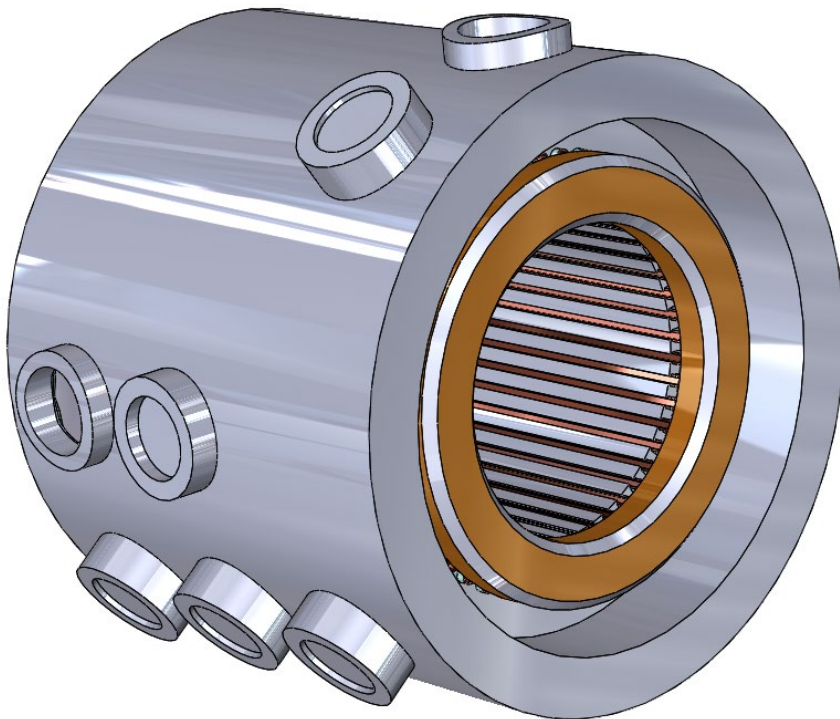

Responses to Previous Year Reviewers' Comments

This is a new project. It was not reviewed in FY14.

Government laboratories

- Oak Ridge National Laboratory
- Argonne National Laboratory

Remaining Challenges and Barriers

- Challenge: Use the data from these experiments to quantify/understand the temperatures experienced by these components during actual, on-the-road driving conditions.

Proposed Future Work

FY15

- Complete testing of the 2012 Nissan Leaf motor thermal management system.
- Characterize and identify methods to improve thermal performance of the 2012 Nissan Leaf and 2014 Honda Accord inverter thermal management systems.

FY16

- Characterize and identify methods to improve the thermal performance of the 2014 Honda Accord motor (oil-cooled system) and 2015 BMW i3 motor and power electronics thermal management systems.

Summary

Relevance

- This work will increase the understanding of the current SOA in motor and power electronics thermal management systems and develop methods to improve on the SOA.

Approach

- Collaborate with industry and ORNL to identify the appropriate vehicle to benchmark
- Characterize the thermal performance of the inverter and motor thermal management systems and share the results with industry
- Identify areas of improvement to advance the SOA and establish baseline metrics for the thermal management systems.

Accomplishments

- Initiated characterization of the 2012 Nissan Leaf motor thermal management system.

Collaborations

- Oak Ridge National Laboratory
- Argonne National Laboratory



Acknowledgment:

Susan Rogers and Steven Boyd,
U.S. Department of Energy

Team Members:

Kevin Bennion
Emily Cousineau
Charlie King
Scot Wayne

For more information contact:

Principal Investigator
Gilbert Moreno
Gilbert.Moreno@nrel.gov
Phone: (303) 275-4450

EDT Task Leader

Sreekant Narumanchi
Sreekant.Narumanchi@nrel.gov
Phone: (303) 275-4062

Reviewer-Only Slides

(Note: please include this “separator” slide between those to be presented and the “Reviewer-Only” slides. These slides will be removed from the presentation file and the DVD and Web PDF files.)

If you do not submit Reviewer-Only slides, your Merit Review score will likely be reduced.

If you have a poster presentation, submit the Reviewer-Only slides with your presentation to Alliance Technical Services but do not include them in your presented poster.

Publications and Presentations

- New project

Critical Assumptions and Issues

- The experiments are designed to measure the performance of the motor and power electronic thermal management systems. This requires test procedures to accurately measure the heat dissipated by the components and the component temperatures. These test procedures do not replicate automotive environments or operating conditions.
- Strategies to improve thermal performance can then be deduced from these measurements.