

Convective Cooling and Passive Stack Improvements in Motors



Kevin Bennion

Principal Investigator

National Renewable Energy Laboratory

Annual Merit Review and Peer Evaluation Meeting

June 18, 2014

Washington, D.C.

PR-5400-61360

Project ID: APE064

This presentation does not contain any proprietary, confidential, or otherwise restricted information.

Overview

Timeline

- Project Start Date: FY 2014
- Project End Date: FY2016
- Percent Complete: 15%

Budget

- Total Project Funding:
 - DOE Share: \$500K
- Funding for FY14: \$500K

Barriers

- Cost
- Performance (Power Density)
- Life

Partners

(Interactions/Collaborations)

- Motor Industry – R&D Input and Application of Research Results
 - Suppliers, end users, and researchers
- Oak Ridge National Laboratory (ORNL) – Motor R&D Lead
 - Tim Burrell (ORNL)
 - Andy Wereszczak (ORNL)
- National Renewable Energy Laboratory (NREL) – Thermal Project Lead

Relevance – Why Motor Cooling?

- **Current Density**
- **Magnet Cost**
 - Price variability
 - Rare-earth materials
- **Material Costs**
- **Reliability**
- **Efficiency**
- **Temperature Distribution**

ATF: Automatic Transmission Fluid

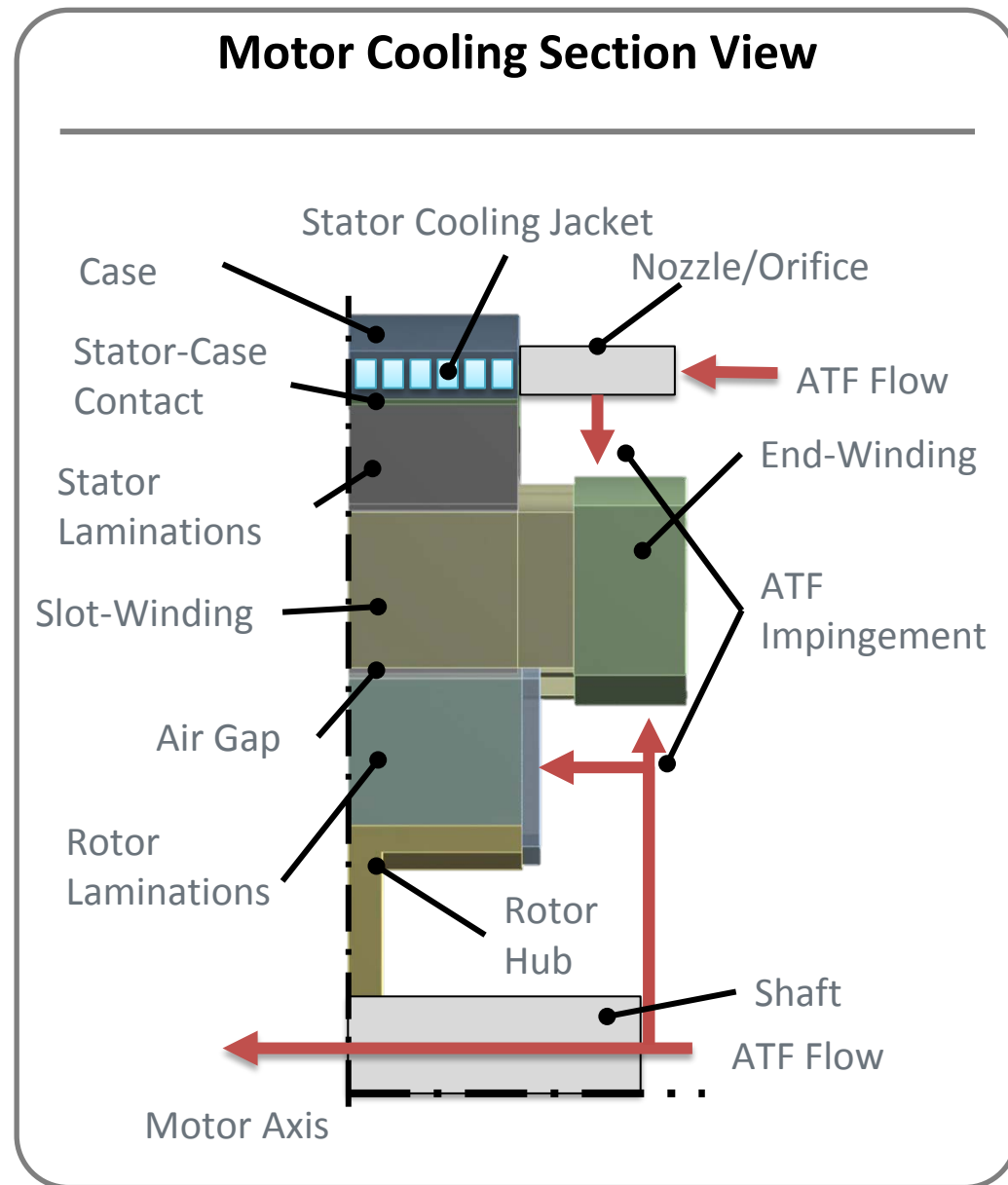

Relevance – Research Objective

Problem



Core Thermal Capabilities
and Research Tasks



Objective

Support broad industry demand for data, analysis methods, and experimental techniques to improve and better understand motor thermal management

Motor Cooling Section View

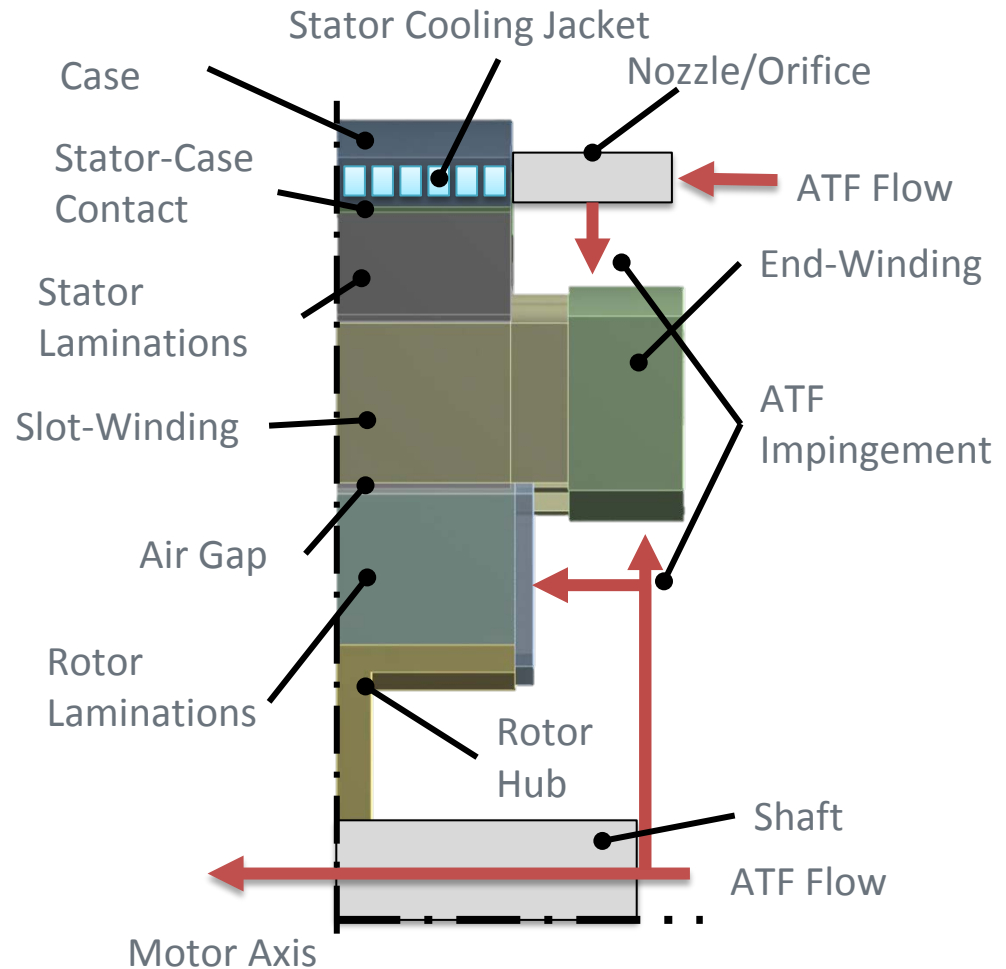

Approach/Strategy – Problem

Problem

- Extracting heat from within the motor to protect motor and enable high power density

Examples

1. Orthotropic (direction dependent) thermal conductivity of lamination stacks
2. Orthotropic thermal conductivity of slot-windings
3. Orthotropic thermal conductivity of end-windings
4. Convective heat transfer coefficients for ATF cooling
5. Thermal contact resistance of stator-case contact
6. Cooling jacket performance

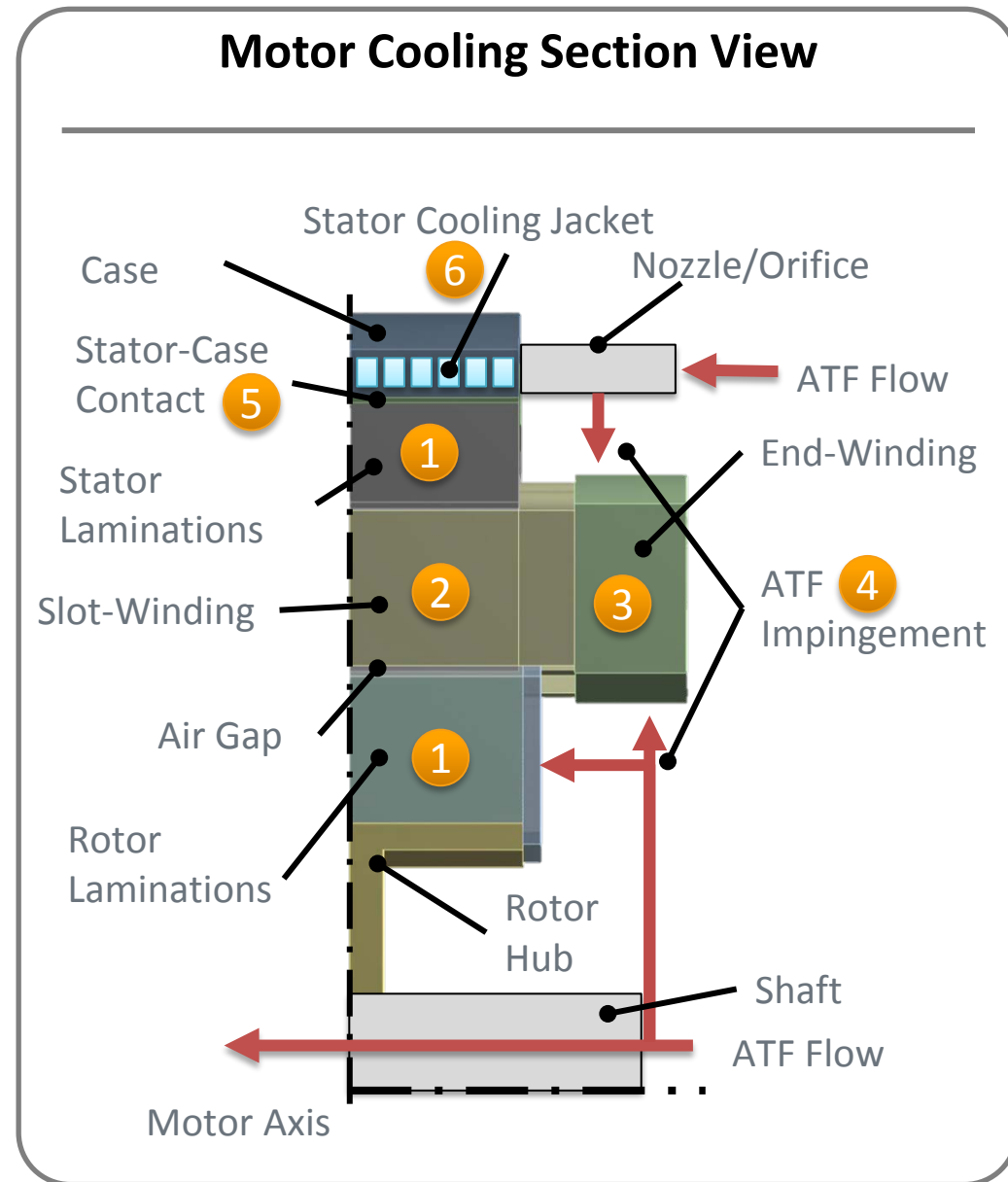

Approach/Strategy – Focus

Core Capabilities

Apply core thermal experimental and modeling capabilities

Tasks

- Measure convective heat transfer coefficients for ATF cooling of end-windings
- Develop computational fluid dynamics (CFD) models for ATF jet impingement
- Measure interface thermal resistances and orthotropic thermal conductivity of materials

Objective

Support broad industry demand for data to improve and better understand motor thermal management

Automatic Transmission Fluid Heat Transfer

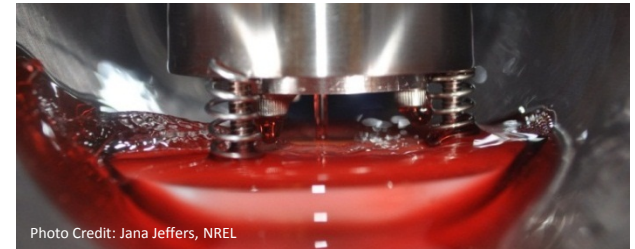

Computational Fluid Dynamics and Modeling

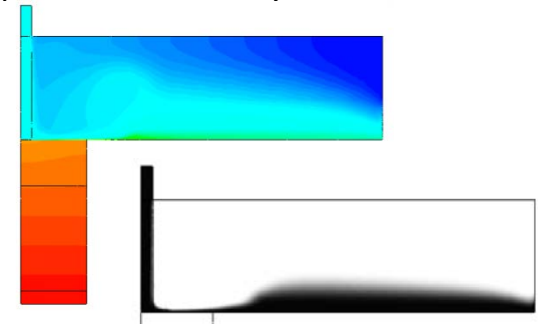

Material and Thermal Interface Testing

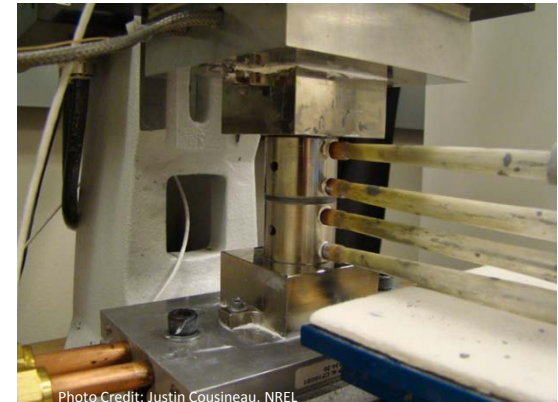

Approach/Strategy – Plan

2013			2014								
Oct	Nov	Dec	Jan	Feb	Mar	Apr	May	Jun	Jul	Aug	Sep

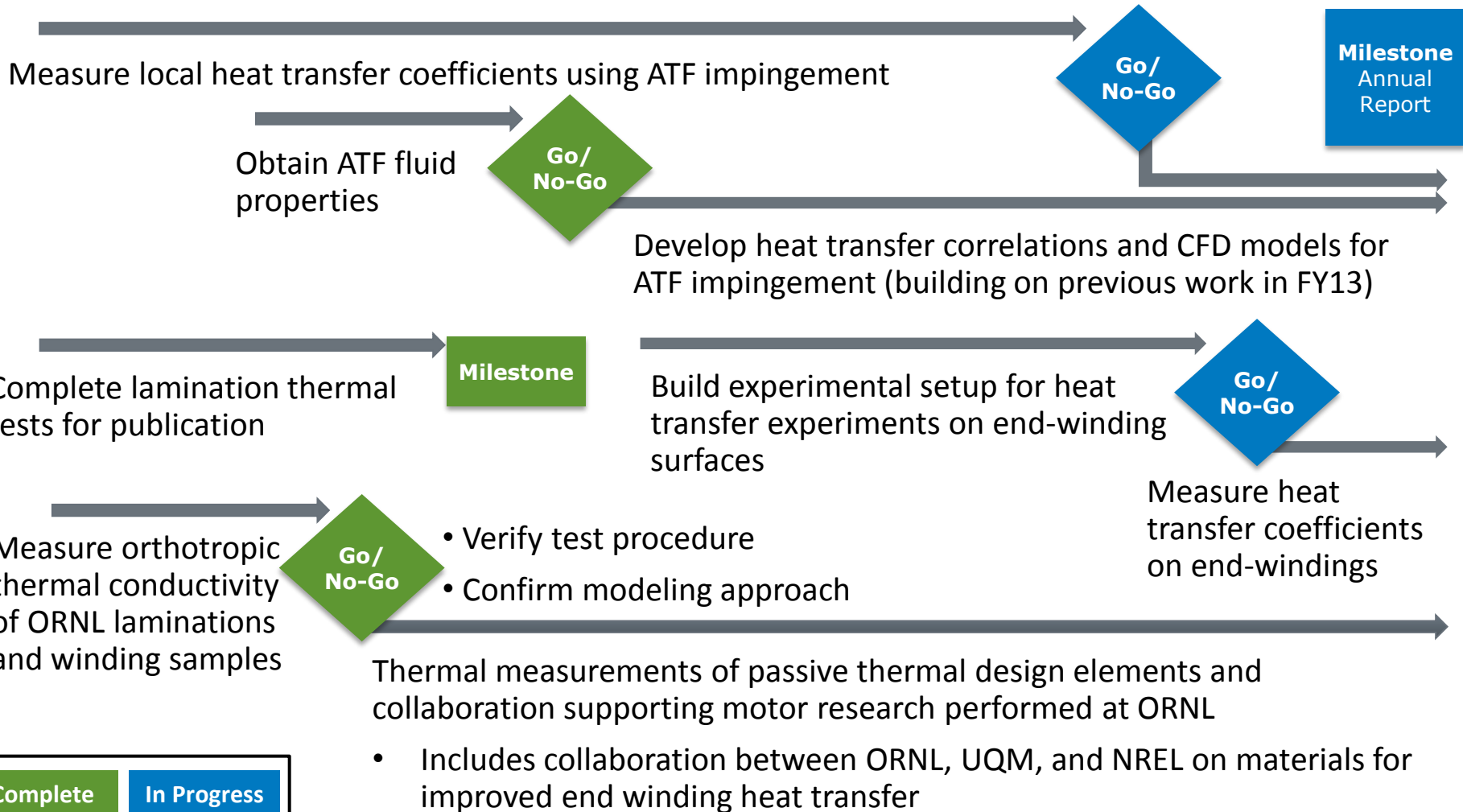

Milestones

Date	Description
December 2013	Go/No-Go <ul style="list-style-type: none">• Measure orthotropic thermal conductivity of ORNL laminations and winding samples• Verified experimental and modeling methods
January 2014	Milestone (internal) <ul style="list-style-type: none">• Completed lamination thermal tests for publication• Began preparation of publication
February 2014	Go/No-Go <ul style="list-style-type: none">• Received ATF fluid property data from Ford Motor Company• Supports future task to develop heat transfer correlations and CFD models
July 2014	Go/No-Go <ul style="list-style-type: none">• Measure local heat transfer coefficients using ATF impingement• Supports future task to develop heat transfer correlations and CFD models
August 2014	Go/No-Go <ul style="list-style-type: none">• Build experimental setup for heat transfer experiments on end-winding surfaces• Supports future task to measure heat transfer coefficients on end-windings
September 2014	Milestone report <ul style="list-style-type: none">• Project summary report for FY14

- ATF Impingement Test Section

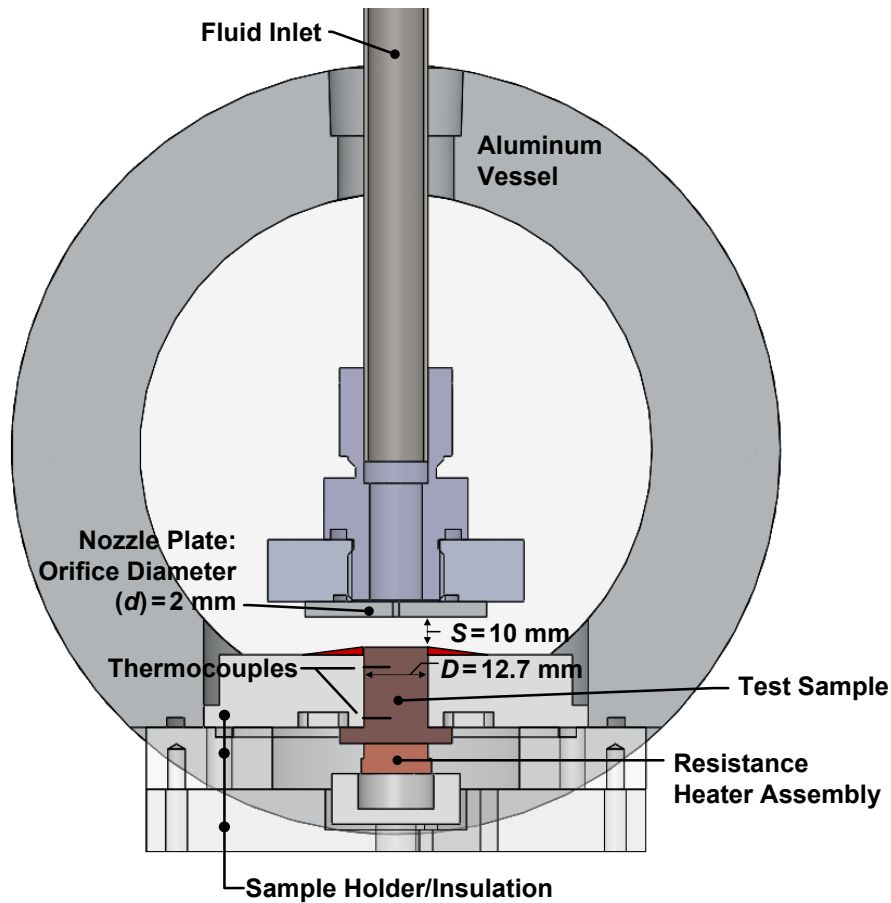

D (mm)	d (mm)	S (mm)	S/d	D/d
12.7	2.06	10	5	6.2

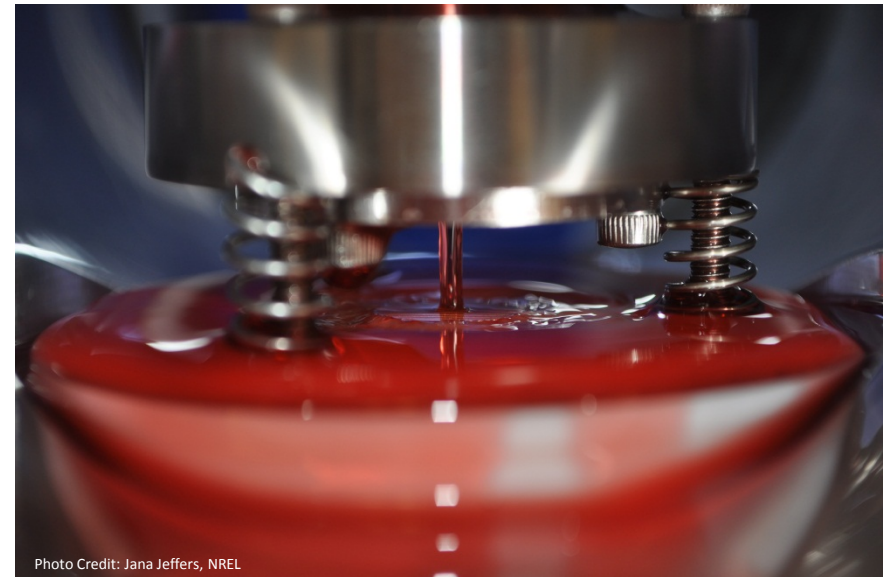

Oil Impingement Test Section Schematic (left). Photo During Operation (right).

Technical Accomplishments

- ATF impingement baseline target is flat polished copper with 600-grit sandpaper
- Additional targets mimic wire bundles with insulation (18, 22, and 26 AWG)

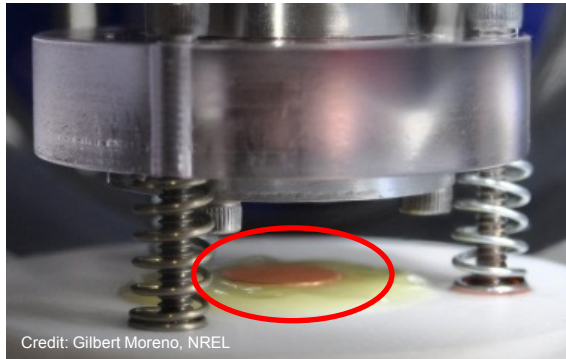

	Baseline	18 AWG	22 AWG	26 AWG
Radius (wire and insulation), mm	N/A	0.547	0.351	0.226
Total wetted surface area, mm ²	126.7	148.2	143.3	139.2

18 AWG

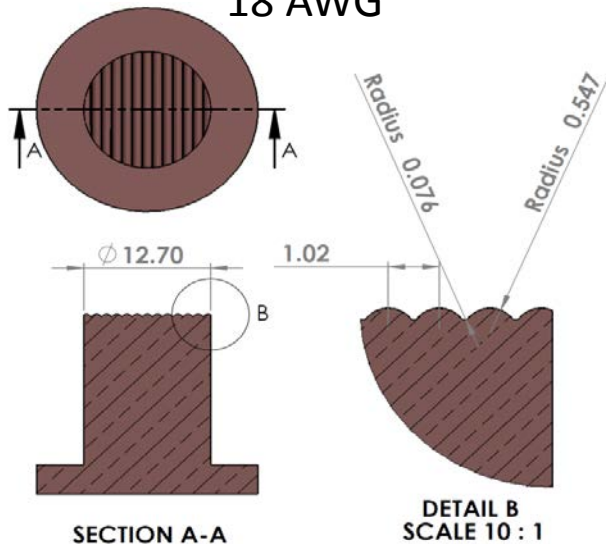

22 AWG

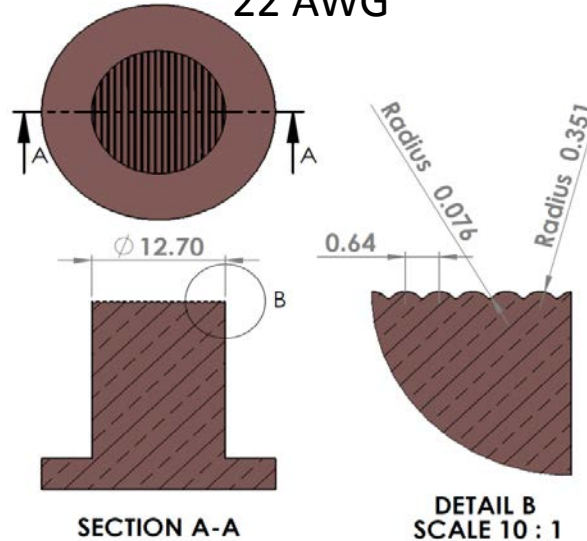

26 AWG

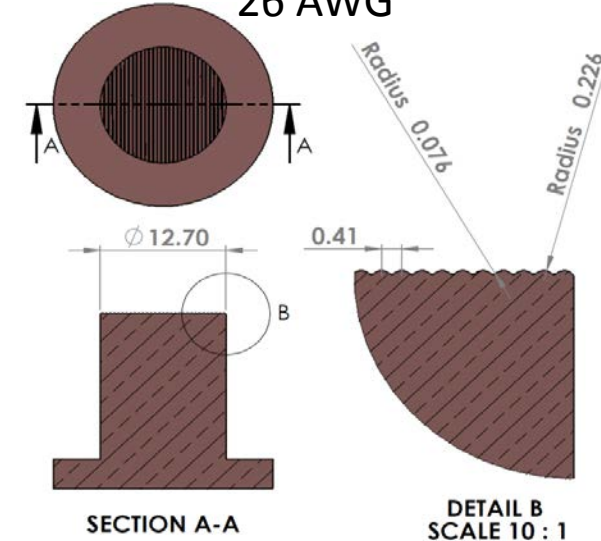

AWG = American Wire Gauge

Technical Accomplishments

50°C Inlet Temperature

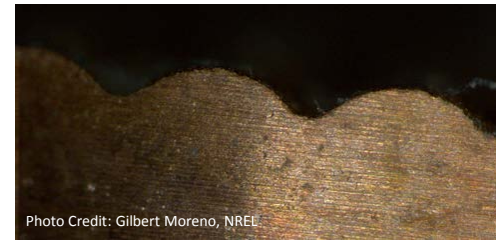
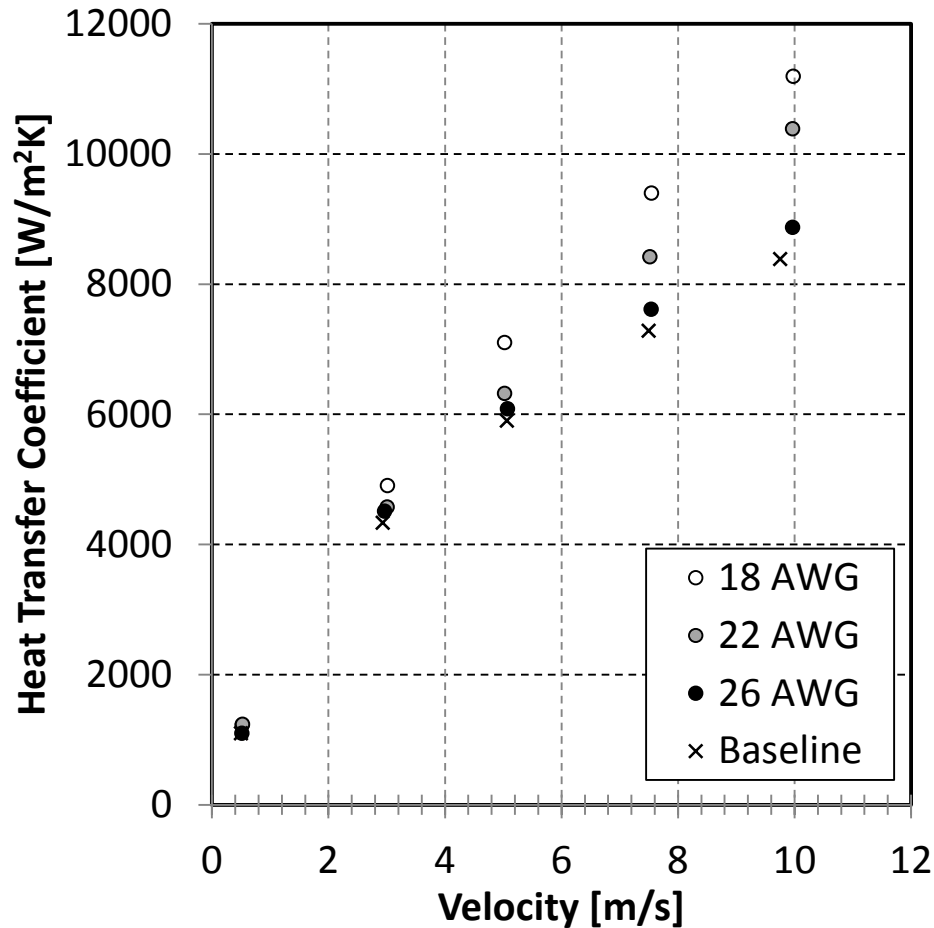

Side View

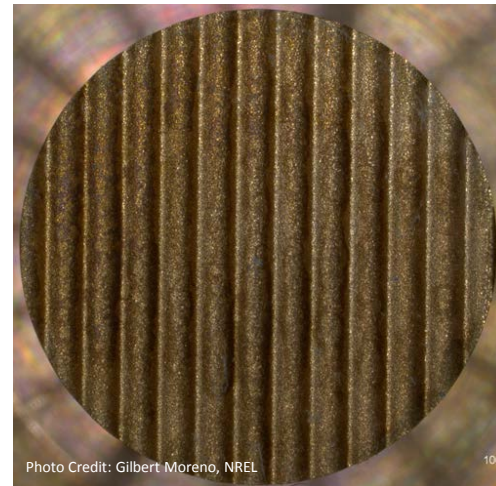

Top View

18 AWG surface target

Heat transfer coefficients of all target surfaces at 50°C inlet temperature

- At lower impingement velocities, all samples achieve similar heat transfer

Note: Heat transfer coefficient calculated from the base projected area (not wetted area)

Technical Accomplishments

- Fluid splatter observed at higher velocities for 70°C and 90°C inlet liquid temperatures
- Fluid splatter more prevalent at higher temperatures
- Splatter at 90°C occurred at lower velocity than at 70°C
- As temperature increases, it is expected that the fluid splatter will occur at lower velocities

18 AWG sample data for all inlet temperatures

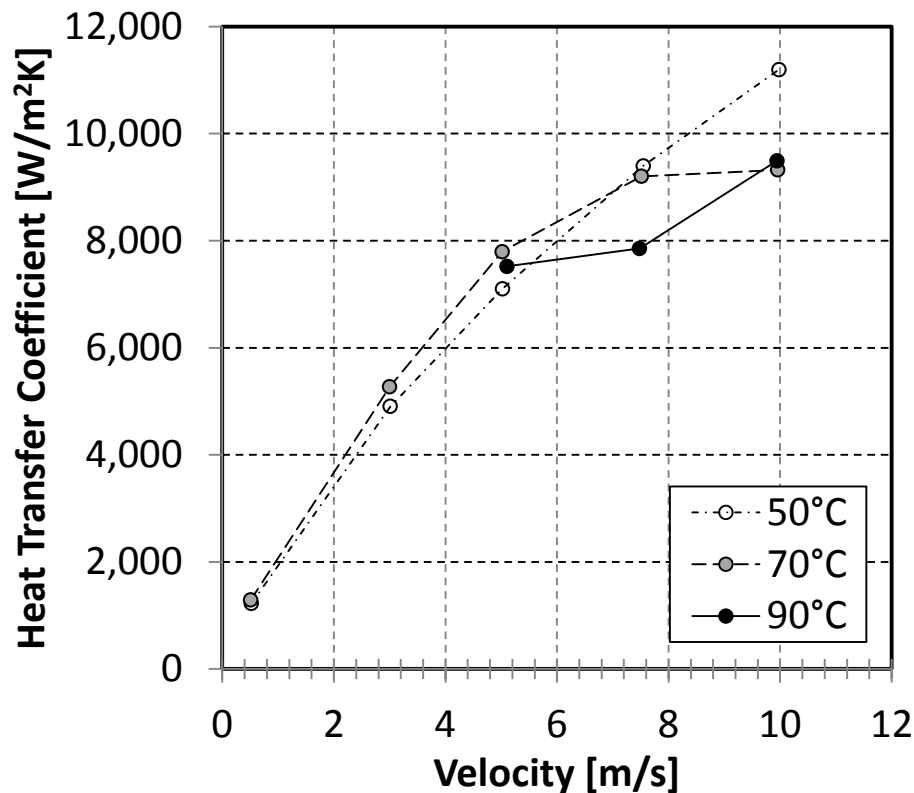

Note: ATF viscosity decreases as temperature increases

ATF flowing over surface

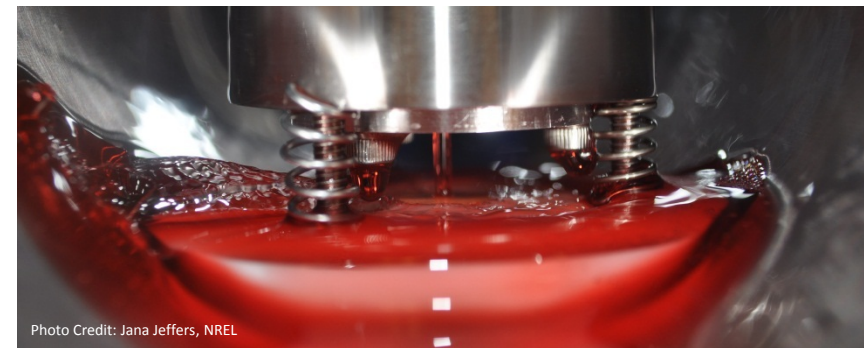

ATF deflecting off surface

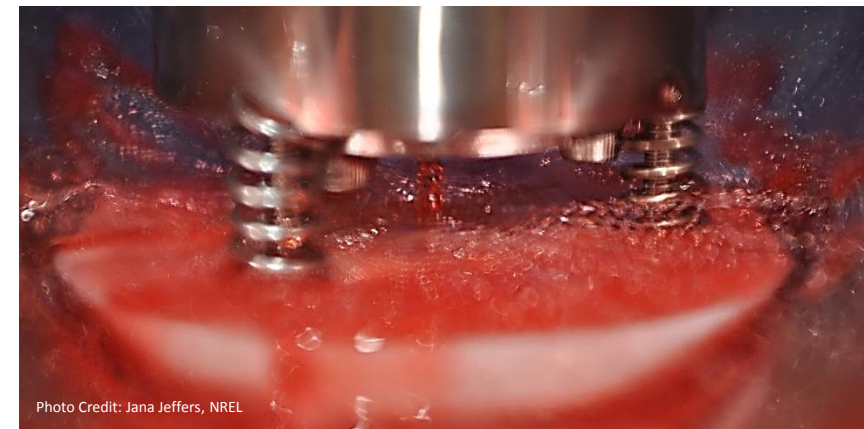

Technical Accomplishments

Measured Stack Thermal Resistance

Lamination-to-Lamination Thermal Contact Resistance

Effective Through-Stack Thermal Conductivity

M19 29 Gauge, 138 kPa Data

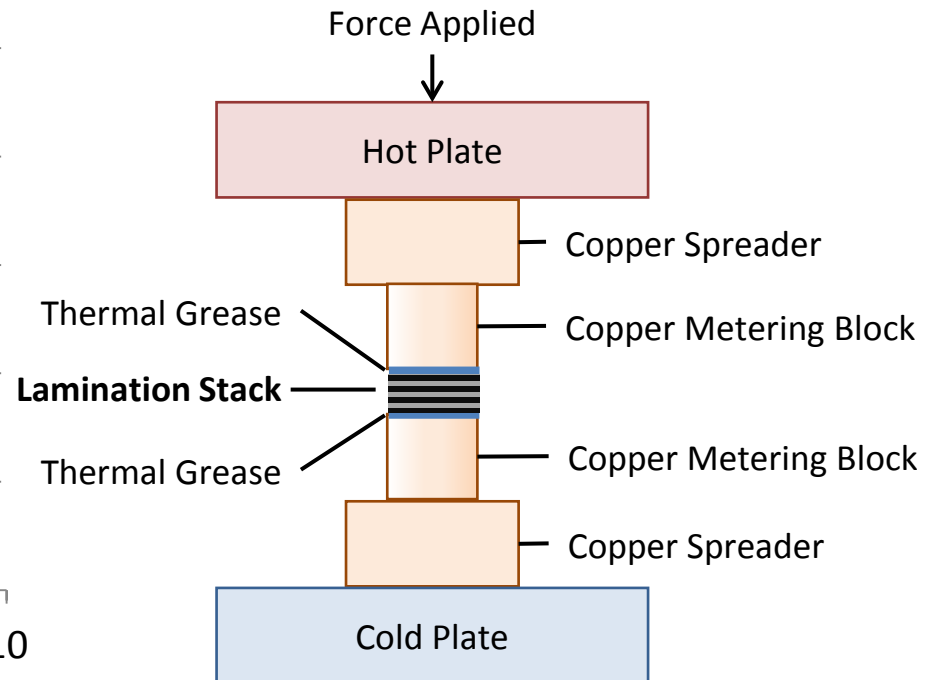
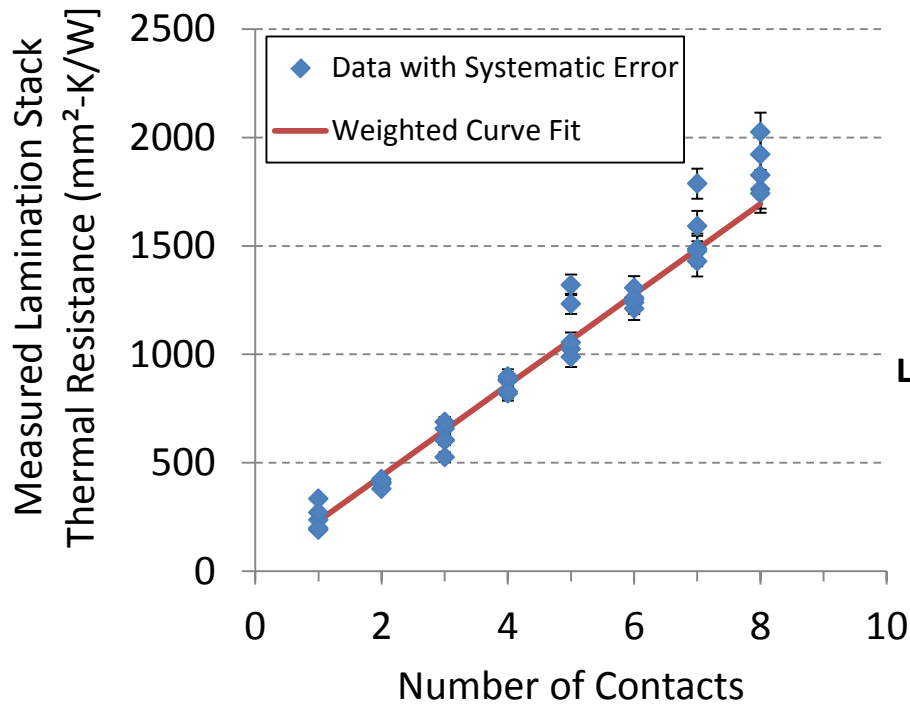

- Lamination-to-lamination thermal contact resistance calculated from slope of weighted curve fit

Error bars represent 95% confidence level

Technical Accomplishments

Measured Stack Thermal Resistance

Lamination-to-Lamination Thermal Contact Resistance

Effective Through-Stack Thermal Conductivity

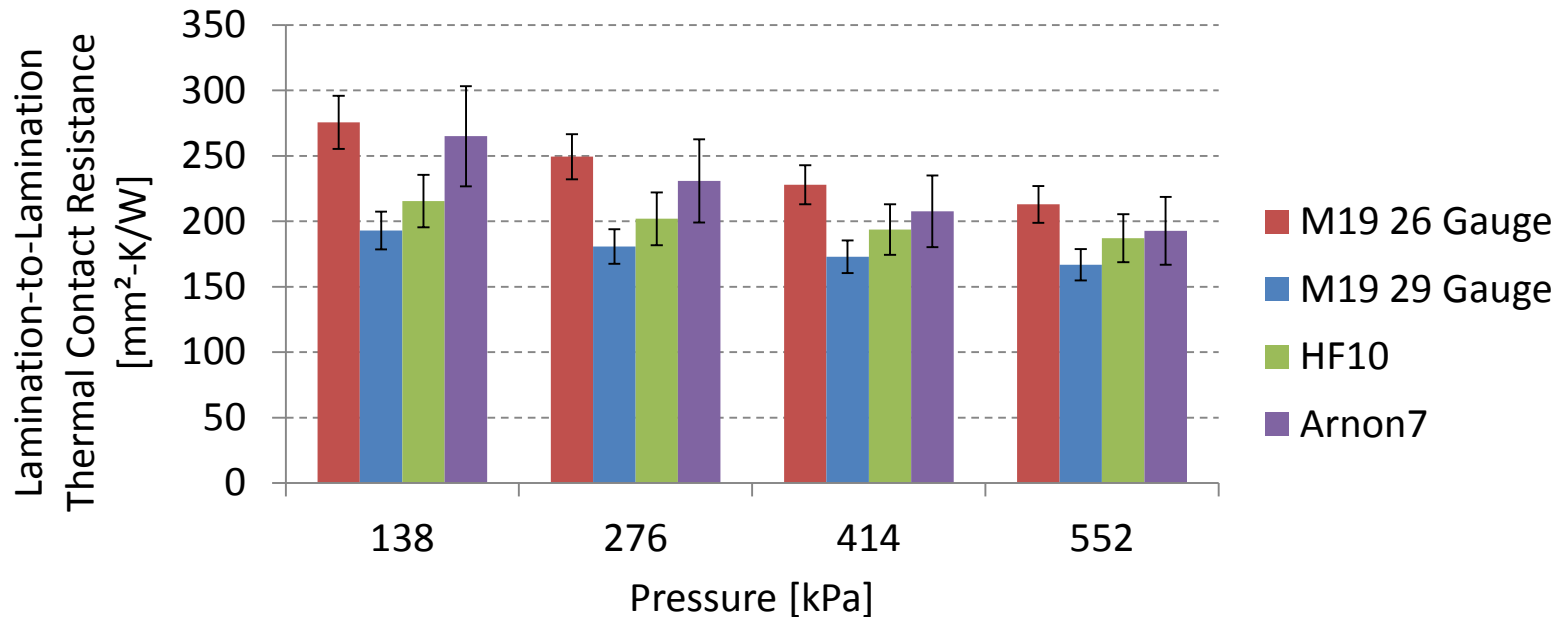

- The lamination-to-lamination thermal contact resistance appears to be affected by the surface roughness
- The effective through-stack thermal conductivity is calculated from:
 - Lamination-to-lamination thermal contact resistance
 - Bulk lamination material thermal resistance
 - Number of laminations

Error bars represent 95% confidence level

Technical Accomplishments

Measured Stack Thermal Resistance

Lamination-to-Lamination Thermal Contact Resistance

Effective Through-Stack Thermal Conductivity

M19 29 Gauge, 138 kPa Example

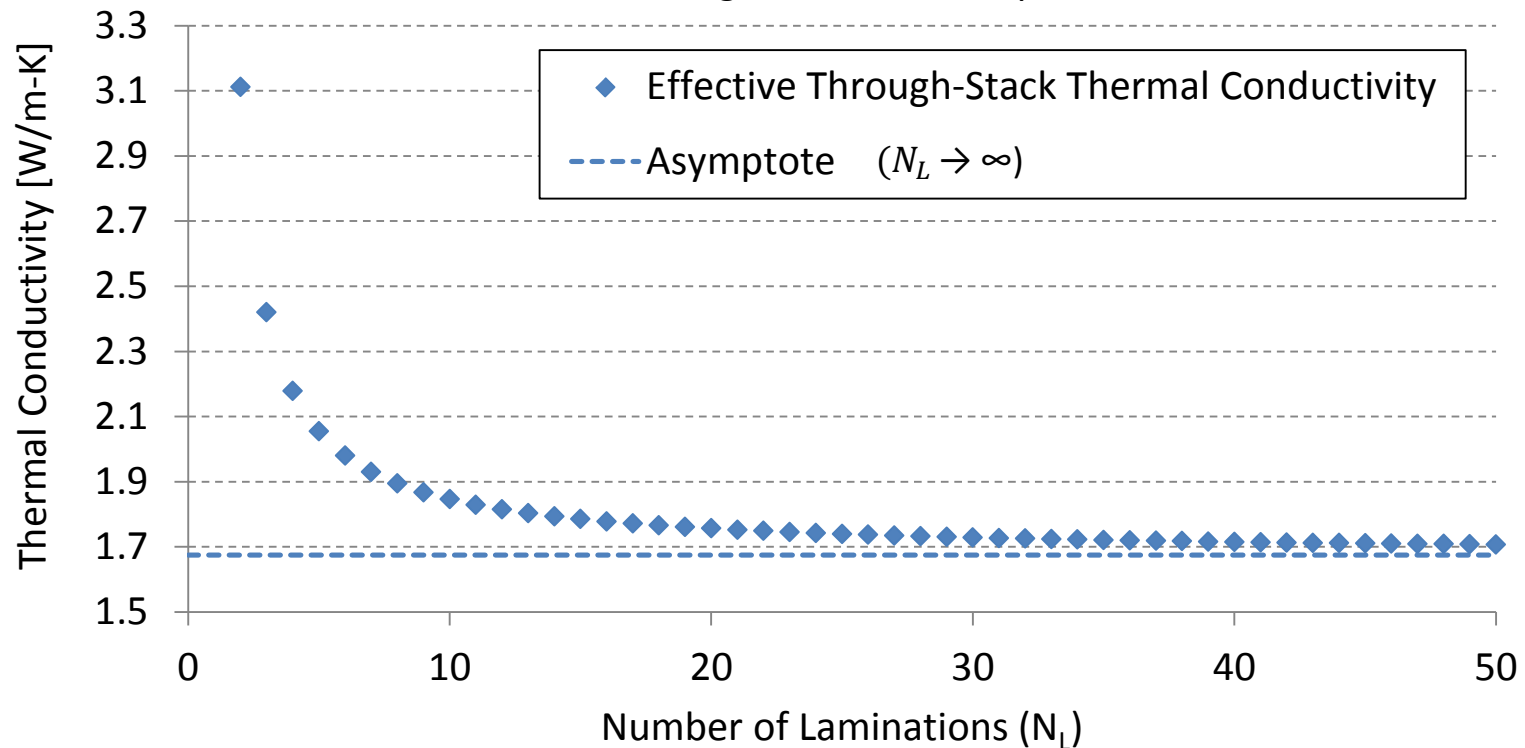

- The effective through-stack thermal conductivity approaches the asymptote within 30–50 laminations

Technical Accomplishments

Measured Stack Thermal Resistance

Lamination-to-Lamination Thermal Contact Resistance

Effective Through-Stack Thermal Conductivity

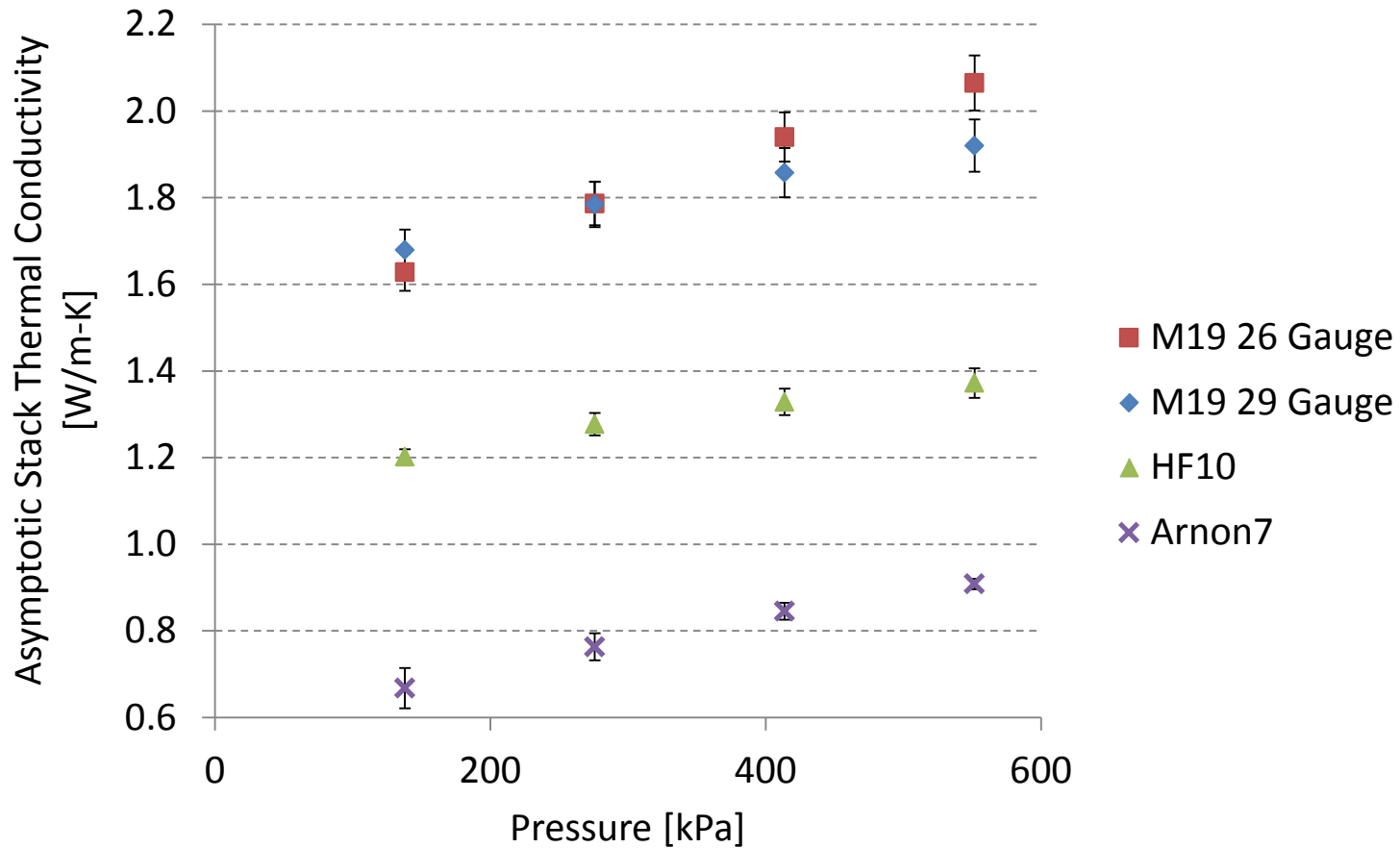

Error bars represent 95% confidence level

Technical Accomplishments

- Measured in-plane thermal conductivity of lamination stacks provided by ORNL

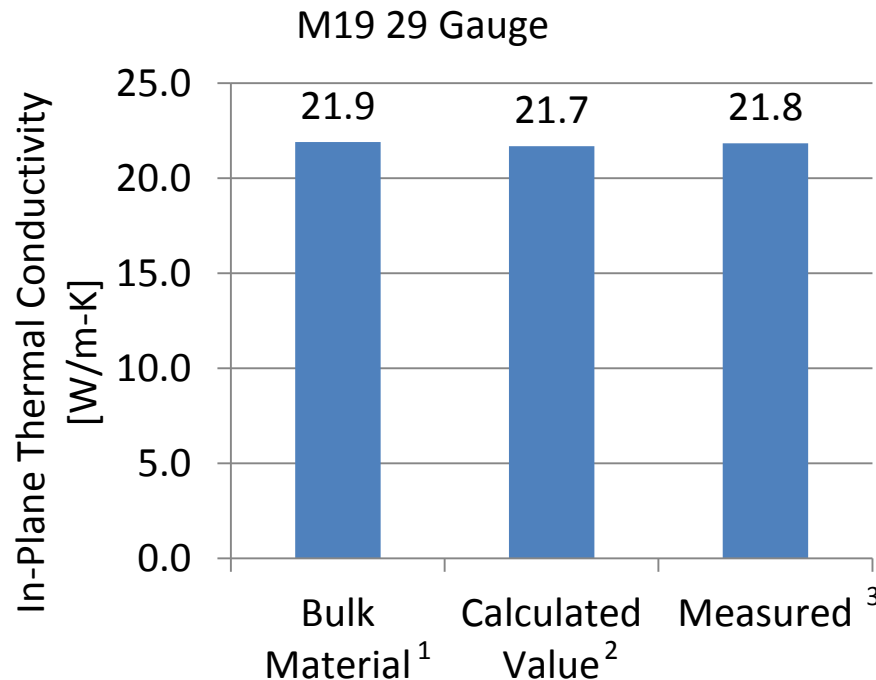

- Confirmed in-plane thermal conductivity is close to bulk material thermal conductivity

- Based on measured thermal conductivity of similar material
- Calculated assuming 99% stacking factor
- Average of measured orthotropic property in setup shown in figure

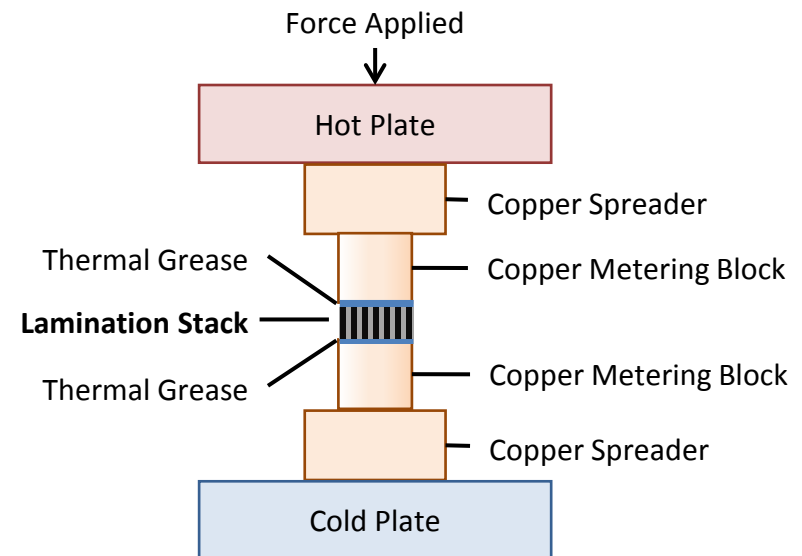
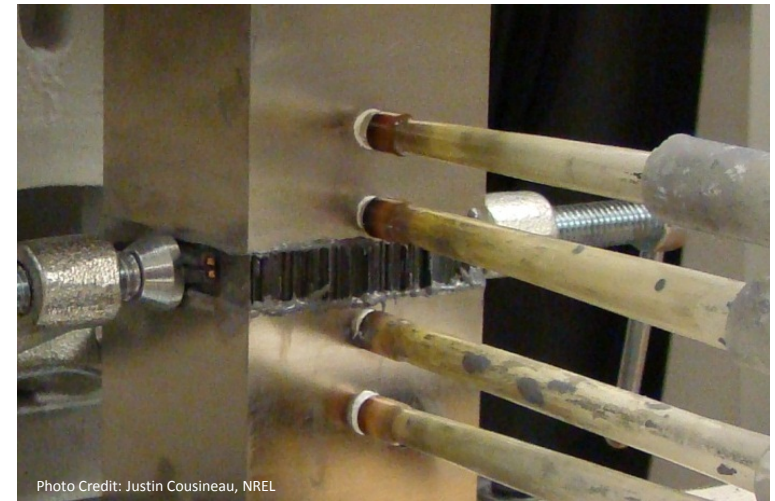

Technical Accomplishments

- Measured cross-slot thermal conductivity of wire bundles prepared and provided by ORNL



Photo Credits: Justin Cousineau, NREL

Note: Wire fill factor includes copper and insulation

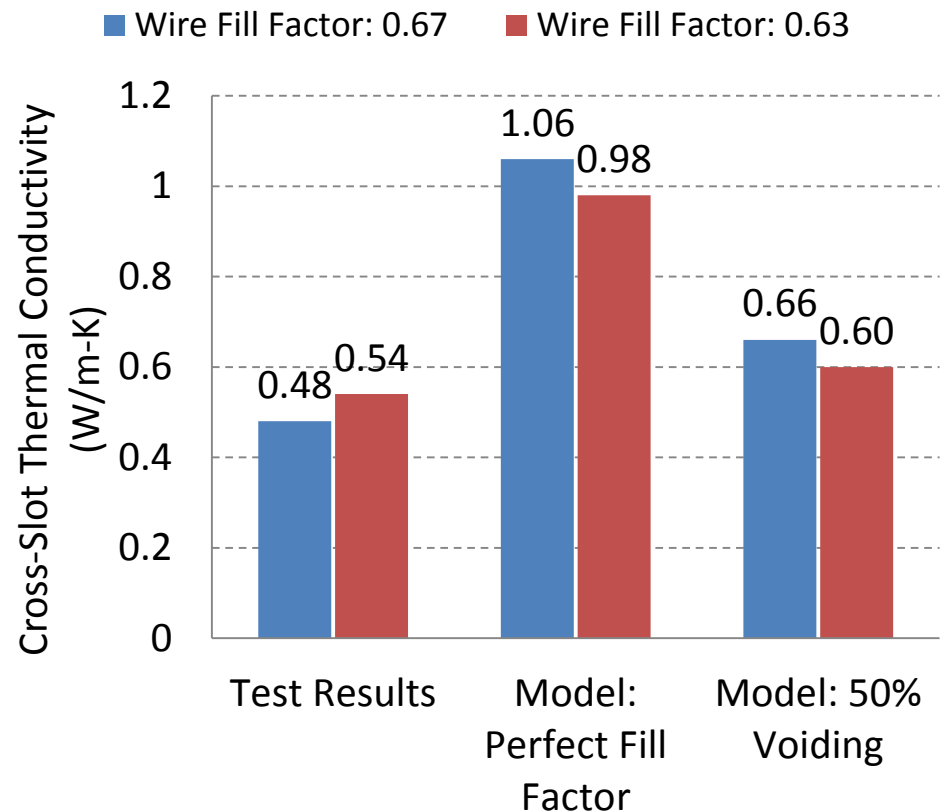

- The agreement between model and experimental results depend on assumptions for fill factor and voiding
- Modeling approach appears to match but additional testing is needed

Response to Previous Year Reviewers' Comments

This project is a new project for FY14 but reviewer input from previous motor thermal research efforts have guided the focus of the current project.

- **Reviewers mentioned oil impingement cooling is an effective method for cooling and a better understanding of this cooling technique is of high interest for automotive applications.**
 - *A focus of this new project includes experimental methods to measure and understand oil impingement cooling.*
- **It was mentioned of past work that “passive thermal design elements are a unique enabler.”**
 - *The second focus area of this project is to work with partners to experimentally characterize passive thermal design elements, which include thermal properties of interfaces and materials for motor applications.*

Collaboration and Coordination with Other Institutions

- **Industry**

- Motor industry suppliers, end users, and researchers
 - Input on research and test plans
 - Sharing of experimental data, modeling results, and analysis methods
 - Companies providing research input, requesting data, or supplying data include: Ford, Chrysler, Tesla, UQM Technologies, Remy, Magna

- **Other Government Laboratories**

- ORNL
 - Support from benchmarking activities
 - Collaboration on motor designs to reduce or eliminate rare-earth materials
 - Collaboration on materials with improved thermal properties
 - Potting materials for end windings for improved heat transfer
 - Slot winding materials

Remaining Challenges and Barriers

Cooling Technology Development

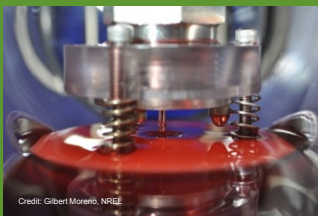

- Correlations of ATF impingement cooling on motor windings
- CFD simulation of ATF impingement cooling
- Variation in local heat transfer coefficients of ATF impingement
- Effective convective heat transfer coefficients for representative end-windings

Passive Thermal Stack and Reliability



- Thermal tests of interfaces and materials for motor cooling
 - Slot-windings
 - End-windings
- In-situ thermal resistance measurements

Proposed Future Work

Ongoing

- Continue ongoing collaboration with ORNL material developments and motor research
- Measurements of thermal interfaces and effective orthotropic thermal properties of materials (windings and potting materials)

FY14

- Develop convection coefficient heat transfer correlations using ATF fluid property information provided by Ford
- Develop methods for simulating impinging ATF fluid jets validated against experimental data
- Utilize infrared imaging and thermochromic liquid crystal (TLC) technology to measure local heat transfer coefficients of impinging ATF fluid jets
- Develop test methods and begin heat transfer measurements on representative end-winding features

FY15

- Measure effective heat transfer coefficients for representative end-windings
- Measure in-situ thermal resistances

Sample TLC Color Representations for Surface Temperature

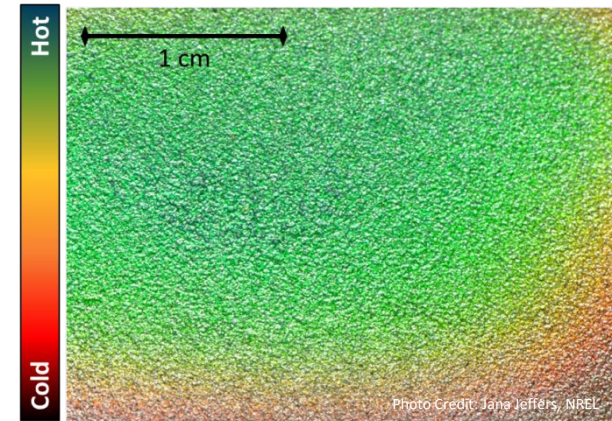

ATF Cooling of Representative Motor End-Winding

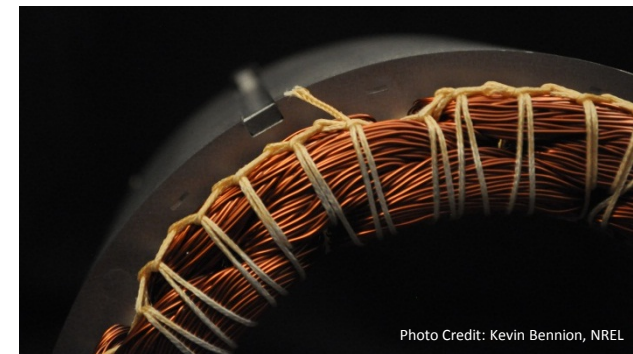

Summary

Relevance

- Supports transition to more electric-drive vehicles with higher continuous power requirements
- Enables improved performance of non-rare earth motors and supports lower cost through reduction of rare earth materials used to meet temperature requirements (dysprosium)

Approach/Strategy

- Engage in collaborations with motor design experts within industry
- Collaborate with ORNL to provide motor thermal analysis support on related motor research at ORNL
- Perform in-house thermal characterization of materials, interface thermal properties, and cooling techniques

Technical Accomplishments

- Measured ATF heat transfer convection coefficients on target surfaces
- Received materials from ORNL and measured orthotropic thermal conductivity
- Completed expanded lamination thermal tests for publication
- Received ATF fluid property data from Ford Motor Company to support future work to develop correlations and CFD models

Collaborations

- Motor industry representatives: manufacturers, researchers, and end users (light-duty and medium/heavy-duty applications)
- Oak Ridge National Laboratory

Acknowledgments:

Susan Rogers and Steven Boyd,
U.S. Department of Energy

Team Members:

Justin Cousineau (NREL)
Jana Jeffers (NREL)
Charlie King (NREL)
Gilbert Moreno (NREL)
Tim Burrell (ORNL)
Andy Wereszczak (ORNL)

For more information, contact:

Principal Investigator
Kevin Bennion
Kevin.Bennion@nrel.gov
Phone: (303)-275-4447

APEEM Task Leader:

Sreekant Narumanchi
Sreekant.Narumanchi@nrel.gov
Phone: (303)-275-4062

Technical Back-Up Slides

Lamination Stacking Factor and Pressure

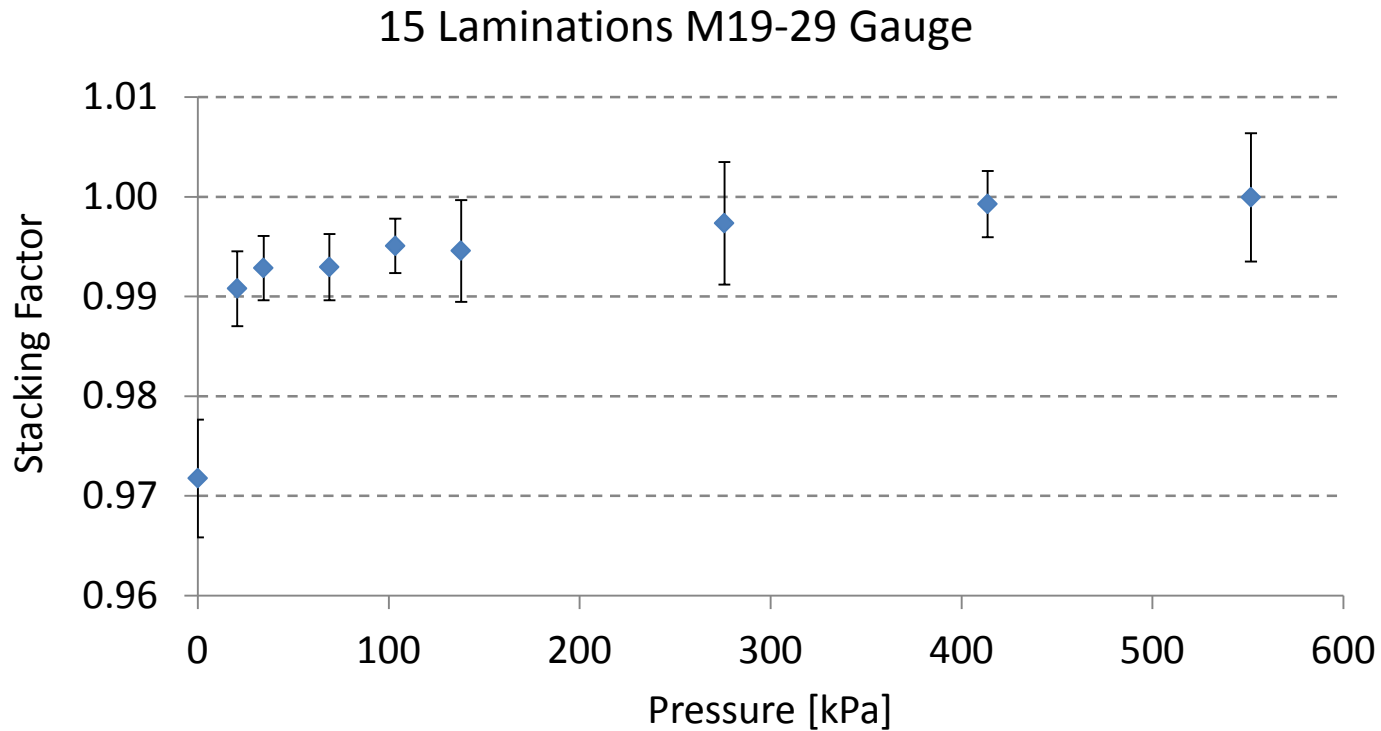

- Graph shows relationship between stacking factor and the applied pressure on the stack of laminations

Error bars represent $\pm U_{95}$ uncertainty