

Two-Phase Cooling of Power Electronics



Gilbert Moreno
National Renewable Energy Laboratory

Vehicle Technologies Program Annual Merit Review
May 14, 2013
Arlington, Virginia

NREL/PR-5400-58171

Project #: APE037

This presentation does not contain any proprietary, confidential, or otherwise restricted information.

Overview

Timeline

Project Start Date: FY11

Project End Date: FY13

Percent Complete: 70%

Budget

Total Project Funding: \$1,500K

DOE Share: \$1,500K

Funding Received in FY12: \$550K

Funding for FY13: \$400K

Barriers

- Weight, cost, and efficiency

Partners

- Delphi
- 3M
- DuPont
- University of Colorado-Boulder
- Project lead: National Renewable Energy Laboratory

Relevance

Project Objective

- Significantly improve thermal management of automotive power electronics by utilizing the high heat transfer rates of two-phase cooling
 - Design a passive, two-phase cooling system for automotive power modules (cool six Delphi discrete power switches)
 - Demonstrate improved thermal performance over existing state-of-the-art automotive cooling systems
 - Demonstrate system can dissipate automotive power electronics heat loads
 - Quantify key program metrics (power density and specific power)

Relevance

- Improved thermal management is an enabler to achieving the DOE APEEM targets
 - Reduce **cost** and increase **power density, specific power, and efficiency**

Milestones

Month / Year	Milestone or Go/No-Go Decision
July 2012	Milestone: Characterized the pool boiling performance of R-245fa. Submitted a conference paper (2013 ASME Heat Transfer Conference) that reported the results
September 2012	Milestone: Designed and fabricated a prototype/proof-of-concept passive two-phase cooling system
February 2013	Go/No-Go Decision: Demonstrated that the passive two-phase cooling system can dissipate at least 2.5 kW of heat using 250 ml of refrigerant
February 2013	Milestone: Identified techniques to improve cooling system performance; submitted a record of invention (ROI)
March 2013	Milestone: Initiated experiments to evaluate the long-term reliability of boiling enhancement coatings

Approach/Strategy

Characterize performance of new, candidate refrigerants

- Heat transfer coefficients
- Critical heat flux
- Temperature effect on performance
- **Complete**

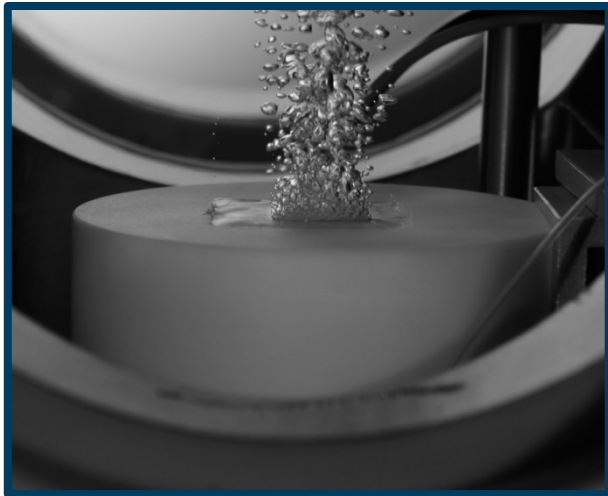

Credit: Gilbert Moreno, NREL

Two-phase heat transfer enhancement

- Microporous coatings
- Nano-structured surfaces
- **Complete**

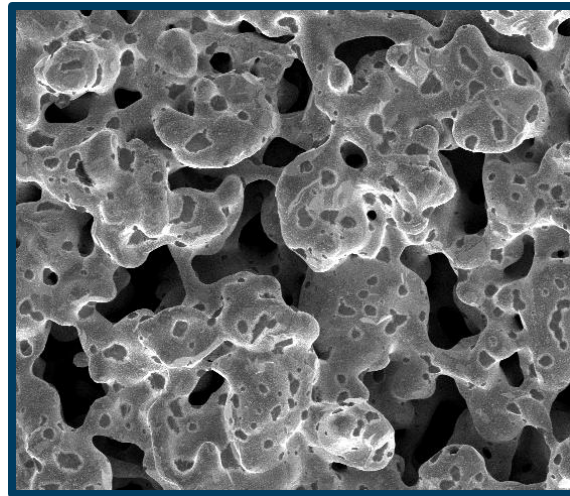

Credit: Bobby To, NREL

Develop passive, two-phase cooling system for automotive power electronics

- Demonstrate improved thermal performance via passive, two-phase cooling

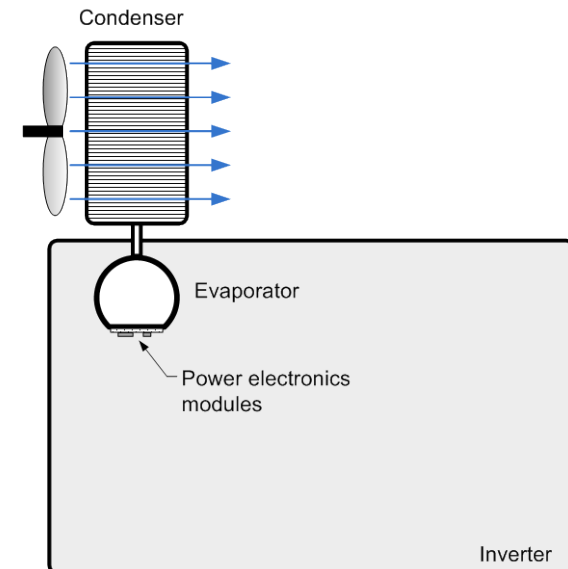

Approach/Strategy

Impacts

The high heat-transfer rates and isothermal characteristics of two-phase cooling can:

- Allow for a reduction in the insulated gate bipolar transistor (IGBT) device count and/or size (cost and size reduction) through an increase in power density
- Increase efficiency through a passive (no pumping requirement) two-phase cooling approach

Uniqueness

- New refrigerants: HFO-1234yf is a new, environmentally friendly refrigerant that may replace R-134a in automotive air conditioning systems
- New boiling enhancement techniques

Technical Accomplishments and Progress

Characterized the pool boiling performance of refrigerant R-245fa

- Measured heat transfer coefficients and critical heat flux at various temperatures
- Compared its performance with other viable refrigerants

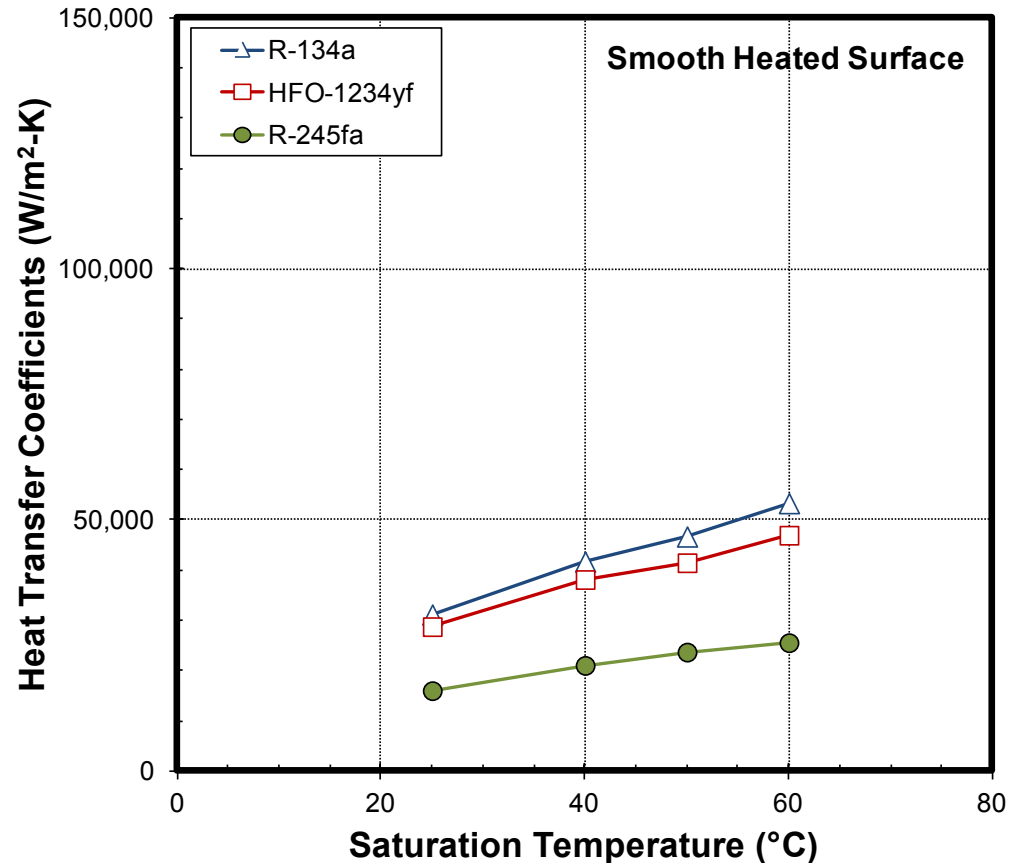

Heat transfer coefficients at $\sim 20 \text{ W/cm}^2$

Technical Accomplishments and Progress

Characterized the pool boiling performance of refrigerant R-245fa

- Enhanced R-245fa heat transfer coefficients by as much as 500% and critical heat flux by 50% using the 3M microporous coating
- Higher heat transfer allows for greater power density
- Less variation in performance using the microporous coating

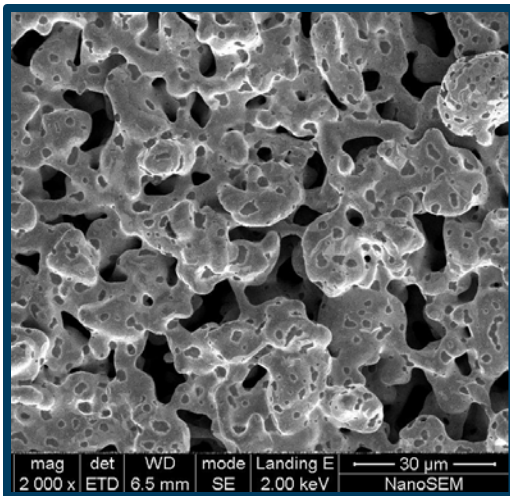

Credit: Bobby To, NREL

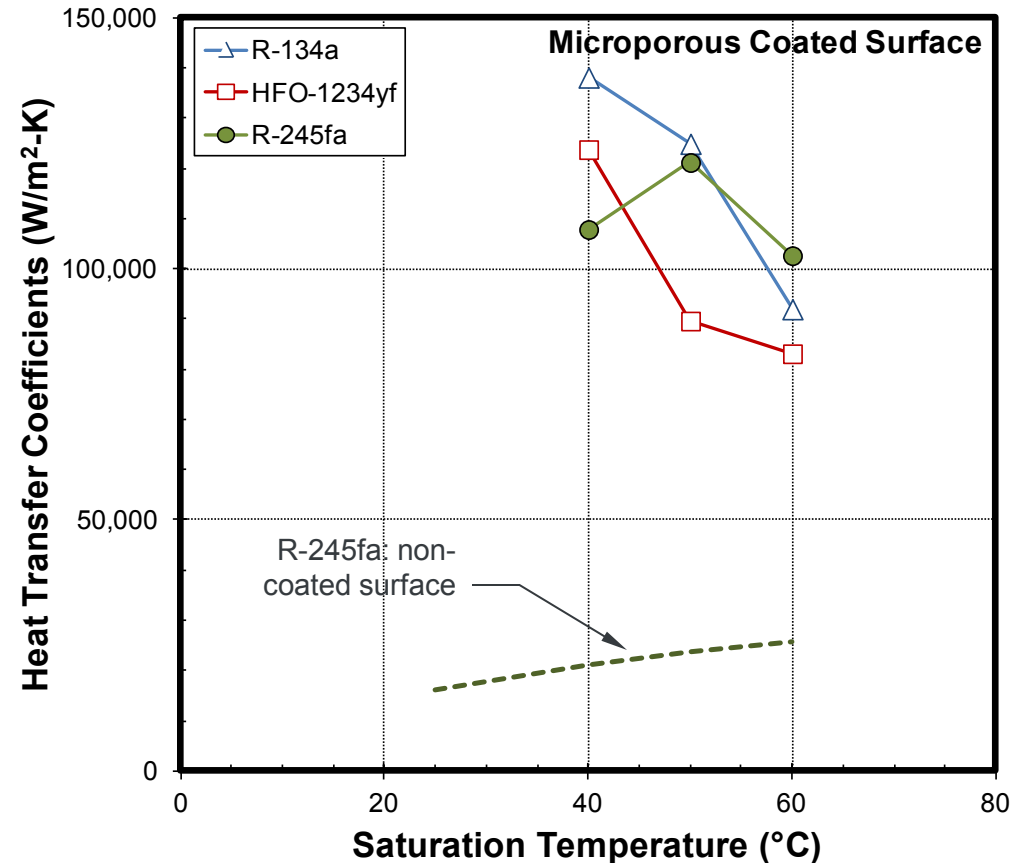

Heat transfer coefficients at ~20 W/cm²

Technical Accomplishments and Progress

Reliability of boiling enhancement coatings

- Initiated experiments to evaluate the long-term reliability of boiling enhancement coatings
- System will thermally stress coated samples by subjecting them to power/temperature (~50% CHF) cycling for a year
- System will characterize the thermal performance over time and evaluate for changes in performance

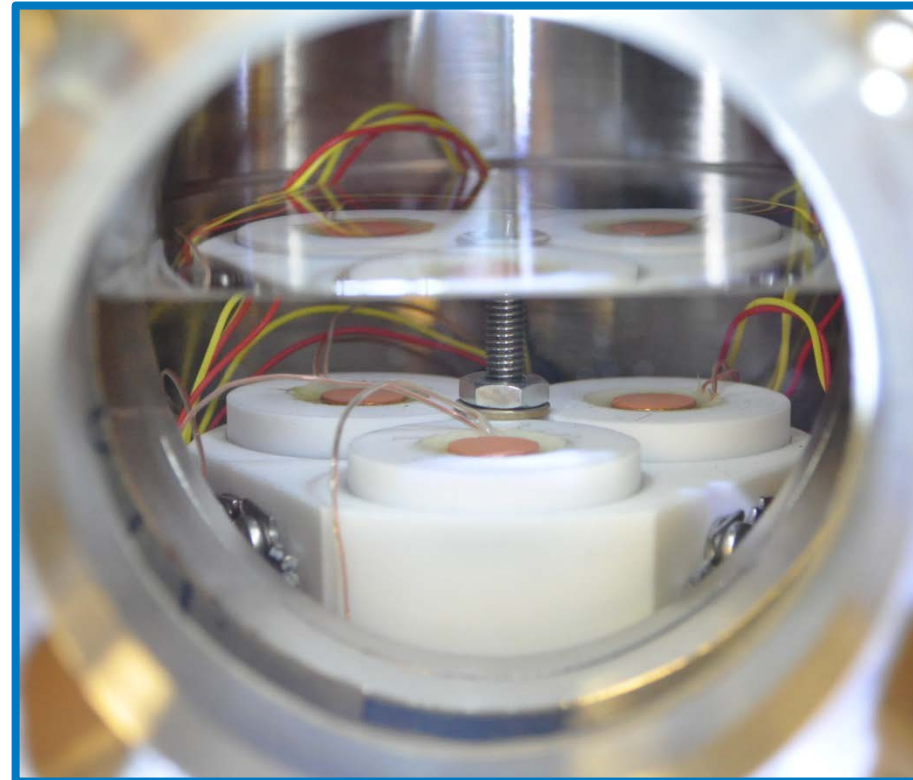

Test samples within the reliability vessel

Credit: Gilbert Moreno, NREL

Technical Accomplishments and Progress

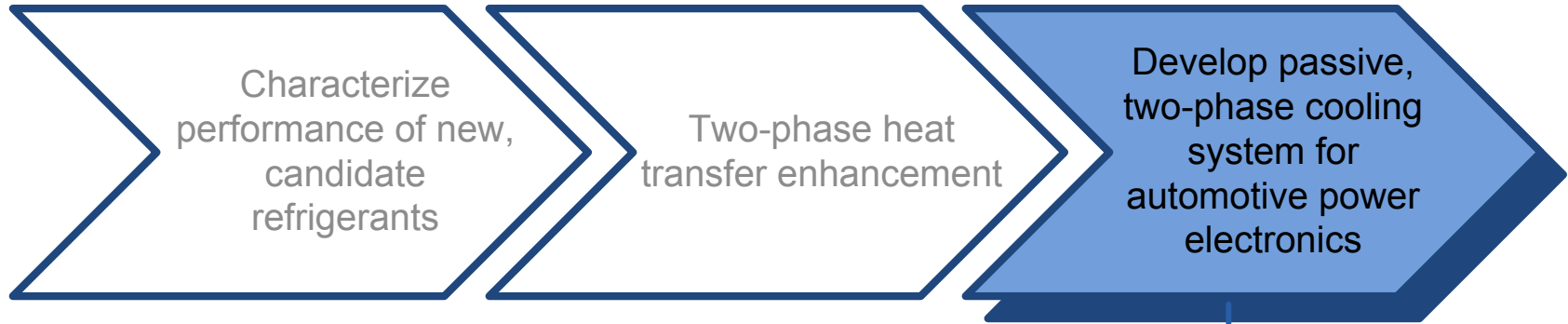

Phase I

Small-scale passive two-phase cooling system experiments

- Focus on improving evaporator performance: finned structures and boiling enhancement coatings
- Define refrigerant quantity requirements

Phase II

Inverter-scale two-phase cooling system experiments

- Cooling system design: evaporator and air-cooled condenser
- Designed to cool automotive power modules (six Delphi discrete power switches)
- Demonstrate systems can dissipate power electronic heat loads
- Quantify performance metrics and compare to state-of-the-art cooling systems

Technical Accomplishments and Progress

Phase I

Fabricated a compact two-phase cooling system

- Indirect cooling (ease of implementation)
- Passive (increase efficiency)

Experiments conducted to:

- Improve evaporator performance: finned structures and boiling enhancement coatings
- Define refrigerant quantity requirements: how much fluid is required to dissipate automotive power electronic heat loads
- Implications for using two-phase heat transfer for power electronics cooling

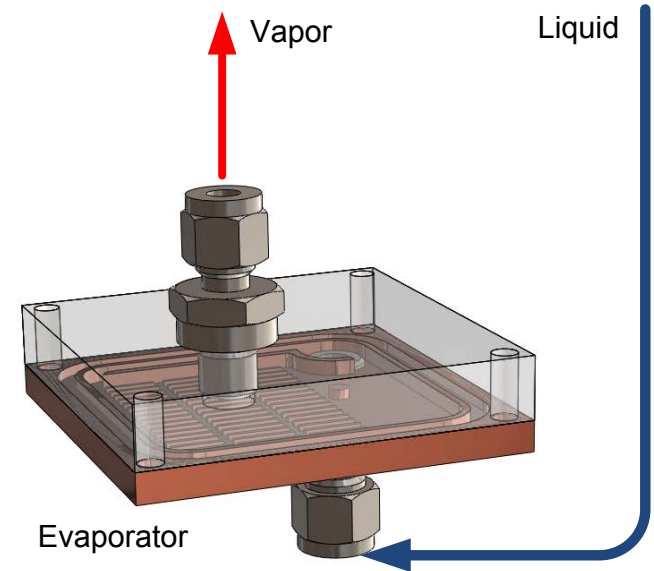

Technical Accomplishments and Progress

Phase I (cont'd)

- Reduced evaporator thermal resistance by about 60% using boiling enhancement coatings
- Estimate it would require ≤ 250 ml of refrigerant (HFO-1234yf or R-245fa) to dissipate 3.5 kW of heat with a passive two-phase configuration

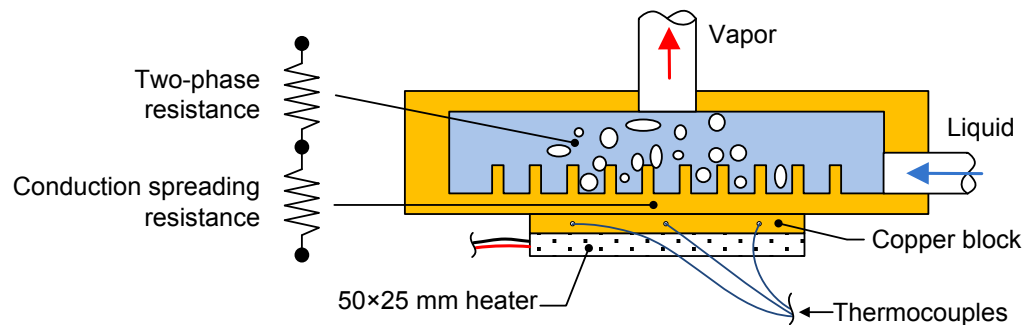

Evaporator resistance: heater to liquid		
	Smooth	Boiling enhancement coating
R''_{th} ($\text{mm}^2\text{-K/W}$)	51.9	21.4

Technical Accomplishments and Progress

Phase II

Designed and fabricated a proof-of-concept passive, two-phase cooling system

- System will be charged and tested with refrigerants HFO-1234yf or R-245fa. Operation with other refrigerants is possible.
- Extensive thermal and structural finite element analysis was conducted
- Designed to cool automotive power modules (six Delphi discrete power switches)
- Fan-cooled condenser
- Indirect cooling scheme: electronics are not in contact with refrigerants
- Passive system: no pump or compressor

Technical Accomplishments and Progress

Passive two-phase cooling system results

Phase II (cont'd)

Initial test conditions:

- Total system charge: 250 ml of R-245fa
- Non-coated evaporator (i.e., no boiling enhancement coating)
- Conducted experiments using six electric heaters to simulate six power modules. Heaters mounted to evaporator/two-phase cold plate using thermal interface material

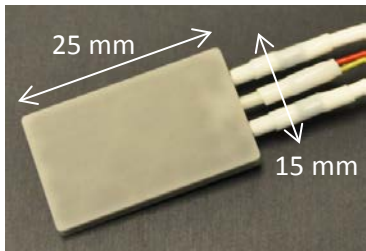

Resistance heater

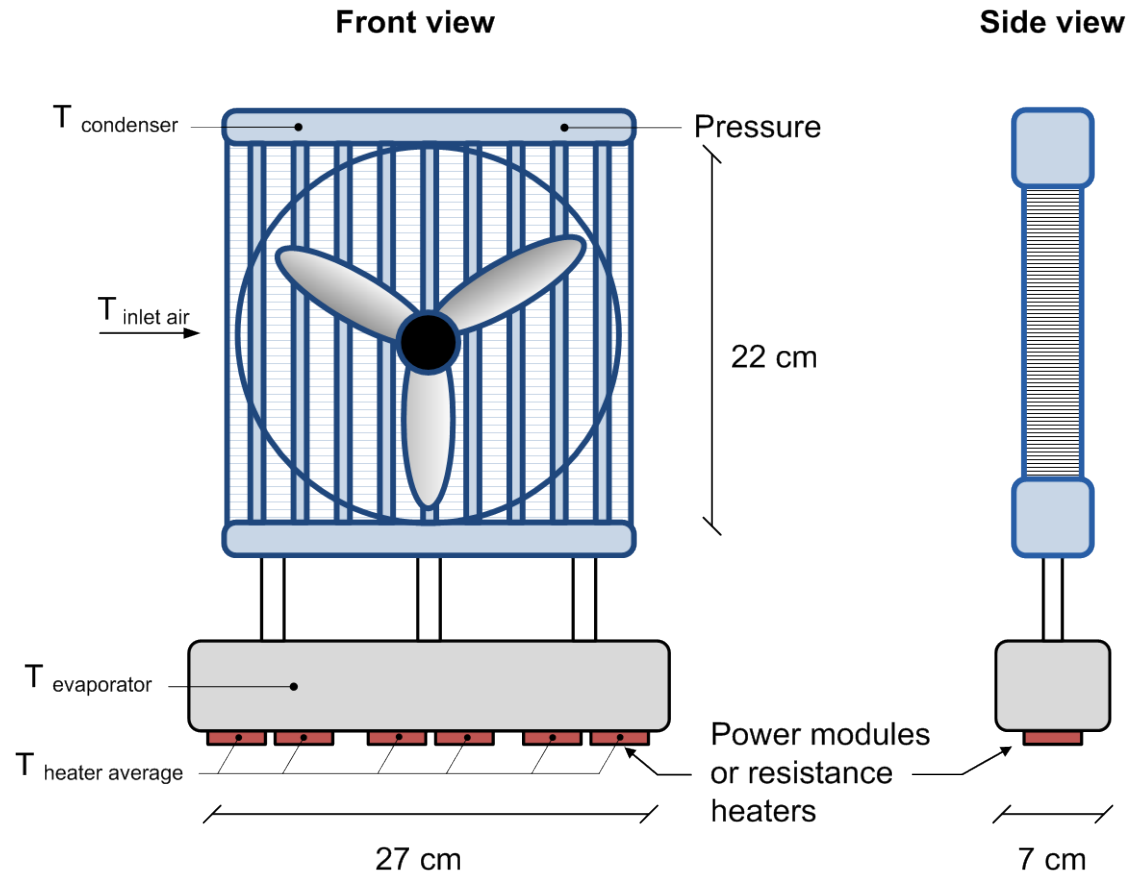

Cooling system schematic

Credit: Gilbert Moreno, NREL

Technical Accomplishments and Progress

Passive two-phase cooling system results

Phase II (cont'd)

Preliminary results:

- Cooling system can dissipate at least 2.5 kW of heat
- Decreasing thermal resistance trend indicates system can dissipate more heat
- System thermal performance will be increased and its size will be reduced through the use of:
 - Enhanced-surfaces: prior results indicate that evaporator thermal resistance can be reduced by 60%
 - Bonded interfaces between heater and evaporator
 - Folded-fin design condenser

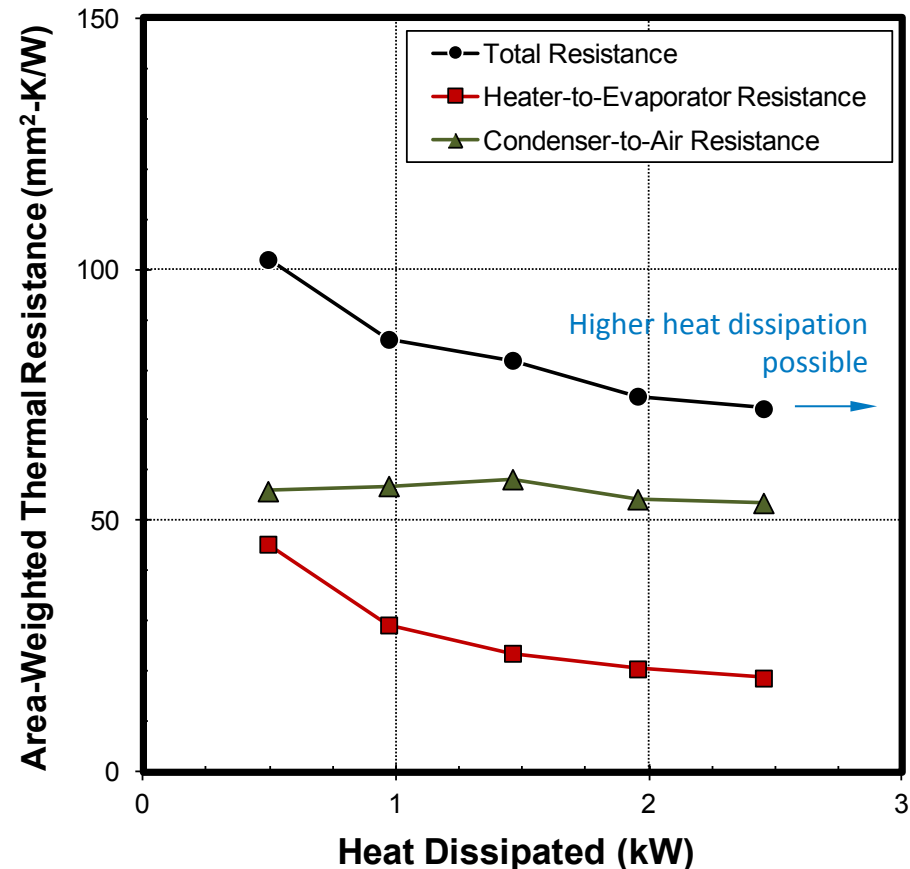

Technical Accomplishments and Progress

Next Steps

- Test to higher power levels
- Implement boiling enhancement coatings within evaporator
- Experiments using refrigerant HFO-1234yf
- Understand effect of inclination on performance
- Cool Delphi power module: measure junction-to-air resistance

Techniques to further improving evaporator performance and reduce manufacturing cost have been identified. ROI has been submitted

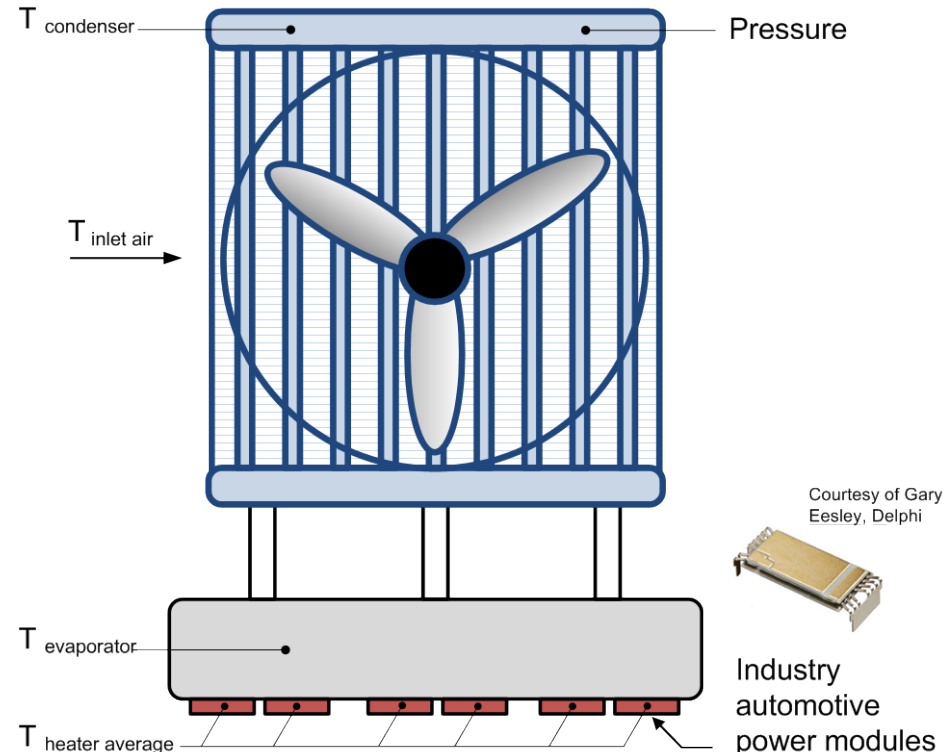

Collaboration and Coordination with Other Institutions

University Partners

- University of Colorado-Boulder (graduate student)
- Iowa State University (provided enhanced surfaces)
- University of Illinois-Chicago (provided enhanced surfaces)

Industry Partners

- Delphi (supplied power modules)
- 3M Electronics Markets Materials Division (supplied boiling enhancement coating)
- DuPont (supplied HFO-1234yf refrigerant)

Proposed Future Work

FY13

Characterize thermal performance of the proof-of-concept two-phase power electronics cooling system

- Measure thermal resistance (junction-to-air) while cooling Delphi's discrete power switch
- Measure maximum heat dissipated
- Understand effects of inclination on thermal performance
- Characterize performance under transient heat loads (drive cycle power profile)
- Compare against performance of conventional water-glycol cooling systems

Proposed Future Work

FY13 (cont'd)

- **Improve two-phase cooling system design to improve performance and decrease size and manufacturing cost**
 - Improve evaporator design
 - Work with industry partner to fabricate a custom-made condenser
- **Evaluate the long-term reliability of boiling enhancement coatings**
- **Develop industry partnership to demonstrate a two-phase cooled inverter system**

Summary

DOE Mission Support

- Enable meeting the DOE APEEM cost, power density, and specific power targets to be achieved via improved thermal management

Approach

- Utilize the high heat transfer rates of two-phase cooling to improve performance
- Demonstrate a passive, two-phase cooling solution for automotive power electronics

Accomplishments

- Characterized the pool boiling performance of R-245fa on plain and microporous-enhanced surfaces
- Demonstrated that a passive, two-phase cooling system can dissipate at least 2.5 kW of heat with 250 ml of refrigerant
- Identified means to enhance passive, two-phase cooling system performance and submitted an ROI
- Initiated experiments to evaluate the long-term reliability of boiling enhancement coatings

Summary

Future work

- Characterize the thermal performance of the proof-of-concept passive, two-phase cooling system
- Further reduce the size and increase the thermal performance of the two-phase cooling system
- Quantify performance metrics (i.e., power density, specific power, and efficiency) for the cooling system. Compare values to those of existing state-of-the-art cooling systems
- Seek collaboration with industry partner to further demonstrate this technology

Collaborations

- Delphi
- 3M
- DuPont
- University of Colorado-Boulder
- Iowa State University
- University of Illinois-Chicago



Acknowledgment:

Susan Rogers and Steven Boyd,
U.S. Department of Energy

Team Members:

Jana Jeffers
Charlie King

For more information contact:

Principal Investigator
Gilbert Moreno
Gilbert.Moreno@nrel.gov
Phone: (303)-275-4450

APEEM Task Leader
Sreekant Narumanchi
Sreekant.Narumanchi@nrel.gov
Phone: (303)-275-4062

Reviewer-Only Slides

(Note: please include this “separator” slide between those to be presented and the “Reviewer-Only” slides. These slides will be removed from the presentation file and the DVD and Web PDF files.)

Responses to Previous Year Reviewers' Comments

“The reviewer noted that critical factors such as size and weight after the various parasitic losses of a real system are accounted for need to be addressed before one can really believe this is a disruptive technical approach. The reviewer also noted that reliability is, of course, also going to get close scrutiny by real-world automotive engineers.”

The plan for this project is to design a passive, two-phase system to cool six automotive power switches (i.e., inverter-scale system). Once the cooling system has been designed and fabricated, we will quantify all the appropriate performance metrics including power density, specific power, and efficiency. The parasitic losses from the condenser fan will be included in the efficiency values computed (i.e., coefficient of performance). Once we have quantified the performance metrics, we will compare them with the performance metrics of current automotive cooling systems. We are also working to evaluate the long-term reliability of boiling enhancement coatings.

“The reviewer noted another area of concern with this approach in the interconnects required between each switch in the design shown; the reviewer wanted to know how will this be accomplished on the production line because of the significant number of connections to make and leak proof.”

We will use an indirect cooling approach for this two-phase design. This will eliminate penetrations (e.g., electrical feedthroughs) into the refrigerant-filled vessel and eliminate chemical compatibility concerns associated with having electronics in contact with a refrigerant. This design should be more reliable and easier to implement.

“First, the quantitative case is made using a scientific approach, rather than an engineering approach or measures of performance (i.e., graphs and charts of coefficients and normalized heat transfer calculations are used, rather than a point design of a working system) in which things like real-world heat exchangers and the need for filters and receivers and whatever else goes with a refrigerant-based system increase system size”

Initial research work was conducted to quantify the heat transfer performance of new refrigerants. This was necessary due to limited information for these new refrigerants. Current work involves design and fabrication of a complete cooling system (i.e., evaporator, condenser, and fan). Once testing of the system is complete we can quantify the APEEM program metrics (i.e., power density, specific power, efficiency). Also, the use of filters, receivers, or compressors are not required for these passive (i.e., no compressor) two-phase cooling systems.

Publications and Presentations

Publications

- Moreno, G., Jeffers, J. R., and Narumanchi, S., 2013 "Pool Boiling Heat Transfer Characteristics of HFO-1234yf on Plain and Microporous-Enhanced Surfaces" Proc. ASME 2013 Heat Transfer Conference, Minneapolis, MN, USA (draft submitted).
- Moreno, G., Narumanchi, S., and King, C., 2012, "Pool Boiling Heat Transfer Characteristics of HFO-1234yf on Plain and Microporous-Enhanced Surfaces," ASME J. Heat Transfer (in press).
- Moreno, G., Narumanchi, S., and King, C., 2011, "Pool Boiling Heat Transfer Characteristics of HFO-1234yf with and without Microporous Enhanced Surfaces," Proc. ASME 2011 International Mechanical Engineering Congress & Exposition, Denver, CO, USA.
- Thiagarajan, S. J., Narumanchi, S., King, C., Wang, W., and Yang, R., 2010, "Enhancement of Heat Transfer with Pool and Spray Impingement Boiling on Microporous and Nanowire Surface Coatings," Proc. ASME 14th International Heat Transfer Conference IHTC-14, Washington, DC, USA.

Presentations

- Moreno, G., Jeffers, J., Narunamchi, S., and King, C., 2012 "Passive Two-Phase Cooling of Automotive Power Electronics using Refrigerant HFO-1234yf" Proc. SAE Thermal Management Systems Symposium, Scottsdale, AZ, USA.
- Moreno, G., Narumanchi, S., Thiagarajan, S. J., Bennion, K., and Venson, T., 2011, "Enhanced Surfaces to Improve Power Electronics," Proc. MEPTEC: The Heat is On, San Jose, CA, USA.
- Tuma, P., Moreno, G., Narumanchi, S., Bennion, K., Brandenburg, S., Olszewski, M., and Burress, T., 2010, "Passive 2-Phase Immersion Cooling of Commercial and Developmental Insulated Gate Bipolar Transistor (IGBT) Modules," Proc. IMAPs ATW on Thermal Management, Palo Alto, CA, USA.

Critical Assumptions and Issues

- Although two-phase cooling is known to be a very efficient means of heat dissipation, concerns associated with complexity, cost, and reliability hinder its implementation. This project intends to address these issues by demonstrating a passive two-phase cooling solution designed to cool advanced power modules (Delphi's discrete power switches). In addition to demonstrating improved thermal performance, we will attempt to address reliability and cost concerns.