

# Passive Solar Design Strategies: Guidelines for Home Building



Passive Solar Industries Council  
National Renewable Energy Laboratory  
Charles Eley Associates  
*With Support From:*  
U.S. Department of Energy

# **Passive Solar Design Strategies: Guidelines for Home Builders**

## **Rock Springs, Wyoming**

Passive Solar Industries Council  
Solar Energy Research Institute  
Charles Eley Associates

This document was prepared under the sponsorship of the Solar Energy Research Institute and produced with funds made available by the United States Department of Energy. Neither the United States Department of Energy, the Solar Energy Research Institute, the Passive Solar Industries Council nor any of its member organizations, nor any of their employees, nor any of their contractors, subcontractors, or their employees, makes any warranty, expressed or implied, or assumes any legal liability or responsibility for the accuracy, completeness or usefulness of any information, apparatus, product or process disclosed, or represents that its use would not infringe privately owned rights. The views and opinions do not necessarily state or reflect those of the United States government, the Solar Energy Research Institute, or any agency thereof. This document was prepared with the assistance and participation of representatives from many organizations, but the views and opinions expressed represent general consensus and available information. Unanimous approval by all organizations is not implied.

## Guidelines

<b>Part One. Introduction</b> . . . . .	1
1. Introduction to the Passive Solar Design Strategies Package . . . . .	2
2. Passive Solar Performance Potential . . . . .	5
<b>Part Two. Basics of Passive Solar</b> . . . . .	7
1. Why Passive Solar? More than a Question of Energy . . . . .	8
2. Key Concepts: Energy Conservation, Suntempering, Passive Solar . . . . .	9
3. Improving Conservation Performance . . . . .	10
4. Mechanical Systems . . . . .	13
5. South-Facing Glass . . . . .	14
6. Thermal Mass . . . . .	15
7. Orientation . . . . .	16
8. Site Planning for Solar Access . . . . .	17
9. Interior Space Planning . . . . .	18
10. Putting it Together: The House as a System . . . . .	18
<b>Part Three. Strategies for Improving Energy Performance in Rock Springs, Wyoming</b> . . . . .	21
1. The Example Tables . . . . .	22
2. Suntempering . . . . .	23
3. Direct Gain . . . . .	24
4. Sunspaces . . . . .	27
5. Thermal Storage Wall . . . . .	30
6. Combined Systems . . . . .	32
7. Natural Cooling Guidelines . . . . .	32

## Worksheets

Blank Worksheets, Data Tables, and Worksheet Instructions

## Worked Example

Description of the Example Building . . . . .	40
Filled in Worksheets . . . . .	43
Annotated Worksheet Tables . . . . .	48

## Appendix

Glossary of Terms . . . . .	51
References . . . . .	52
Summary Tables . . . . .	54
Technical Basis for the Builder Guidelines . . . . .	56

## Acknowledgements

*Passive Solar Design Strategies: Guidelines for Home Builders* represents over three years of effort by a unique group of organizations and individuals. The challenge of creating an effective design tool that could be customized for the specific needs of builders in cities and towns all over the U.S. called for the talents and experience of specialists in many different areas of expertise.

*Passive Solar Design Strategies* is based on research sponsored by the United States Department of Energy (DOE) Solar Buildings Program, and carried out primarily by the Los Alamos National Laboratory (LANL), the Solar Energy Research Institute (SERI) and the Florida Solar Energy Center (FSEC).

The National Association of Home Builders (NAHB) Standing Committee on Energy has provided invaluable advice and assistance during the development of the Guidelines.

Valuable information was drawn from the 14-country International Energy Agency (IEA), Solar Heating and Cooling program, Task VIII on Passive and Hybrid Solar Low Energy Buildings (see next page for more about the international context of *Passive Solar Design Strategies*).

PSIC expresses particular gratitude to the following individuals: **J. Douglas Balcomb**, SERI and LANL, whose work is the basis of the Guidelines; **Robert McFarland**, LANL, for developing and programming the calculation procedures; **Alex Lekov**, SERI, for assistance in the analysis; **Subrato Chandra** and **Philip W. Falrey**, FSEC, whose research has guided the natural cooling sections of the guidelines; the members of the NAHB Standing Committee on Energy, especially **Barbara B. Harwood**, **Donald L. Carr**, **James W. Leach** and **Craig Eymann**, for the benefit of their long experience in building energy-efficient homes; at U.S. DOE, **Frederick H. Morse**, Director of the Office of Solar Heat Technologies and **Mary-Margaret Jenlor**, Program Manager; **Nancy Carlisle** and **Paul Notari** at SERI; **Helen English**, Executive Director of PSIC; **Michael Bell**, former Chairman of PSIC, and **Layne Ridley** and **Elena Marcheso-Moreno**, former Executive Directors of PSIC; **Arthur W. Johnson**, for technical assistance in the development of the Guidelines and worksheets; **Michael Nicklas**, who worked on the Guidelines from their early stages and was instrumental in the success of the first pilot workshop in North Carolina; **Charles Eley**, for his help in every aspect of the production of the Guidelines package.

Although all the members of PSIC, especially the Technical Committee, contributed to the

financial and technical support of the Guidelines, several contributed way beyond the call of duty. **Stephen Szoke**, National Concrete Masonry Association, Chairman of PSIC's Board of Directors; **James Tann**, Brick Institute of America, Region 4, Chairman of PSIC's Technical Committee; and **Bion Howard**, NAHB National Research Center, past Chairman of the Technical Committee, all gave unstintingly of their time, their expertise, and their enthusiasm.

## Solar Design Strategies and the International Energy Agency

Valuable information from the International Energy Agency's Solar Heating and Cooling research program has been integrated into *Solar Design Strategies*.

Under the leadership of the U.S. Department of Energy (Michael J. Holtz, Operating Agent on behalf of DOE) the IEA Task VIII is producing a series of Design Information Booklets on a number of issues related to the design and construction of passive solar residential buildings. Among the booklets will be design guidelines for each of the 14 nations participating in Task VIII. *Solar Design Strategies* is the U.S. contribution to this part of the Design Information Booklet series.

All the IEA Task VIII Design Information Booklets will be available from PSIC. The booklets include:

- Booklet 1: "Energy Design Principles in Buildings" explains the heat transfer principles critical to the thermal comfort of passive solar buildings.
- Booklet 2: "Design Context" presents a checklist of factors to be considered in the design process.
- Booklet 3: "Design Guidelines" specifically developed for each nation. "Solar Design Strategies" will present site-specific design

guidelines for cities and towns in the U.S.

- Booklet 4: "Design Tool Selection and Use" provides guidance in the selection of design tools appropriate for each step of the design process.
- Booklet 5: "Construction Details" identifies solutions to construction problems unique to passive solar buildings.
- Booklet 6: "Passive Solar Homes: Case Studies" highlights the performance of buildings constructed and monitored by Task VIII countries.
- Booklet 7: "Design Language" written primarily for design professionals and students, describes an approach to generating whole building design solutions based on climate analysis and design-centered analysis.
- Booklet 8: "Post-Construction Activities" discusses aspects of passive homes that are unique and may require attention by the occupants and home builders. PSIC would like to express its thanks to the Task VIII member nations for the wealth of information their long-term commitment to international solar research has made possible.

Passive Solar  
Design Strategies

# GUIDELINES

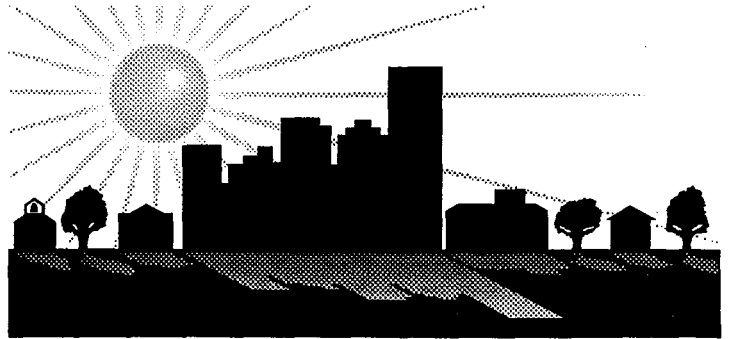

Passive Solar Industries Council  
National Renewable Energy Laboratory  
Charles Eley Associates  
*With Support From:*  
U.S. Department of Energy

## **Part One: Introduction**

- 1. Introduction to the Passive Solar Design Strategies Package**
- 2. Passive Solar Performance Potential**



## 1. Introduction to the Passive Solar Design Strategies Package

The idea of passive solar is simple, but applying it effectively does require information and attention to the details of design and construction. Some passive solar techniques are modest and low-cost, and require only small changes in a builder's standard practice. At the other end of the spectrum, some passive solar systems can almost eliminate a house's need for purchased energy — but probably at a relatively high first cost.

In between are a broad range of energy-conserving passive solar techniques. Whether or not they are cost-effective, practical and attractive enough to offer a market advantage to any individual builder depends on very specific factors such as local costs, climate and market characteristics.

*Passive Solar Design Strategies: Guidelines for Home Builders* is written to help give builders the information they need to make these decisions.

*Passive Solar Design Strategies* is a package in three basic parts:

- The **Guidelines** contain information about passive solar techniques and how they work, and provides specific examples of systems which will save various percentages of energy;
- The **Worksheets** offer a simple, fill-in-the-blank method to pre-evaluate the performance of a specific design.
- The **Worked Example** demonstrates how to complete the worksheets for a typical residence.

### **BuilderGuide**

A special builder-friendly computer program called *BuilderGuide* has been developed to automate the calculations involved in filling out the four worksheets. The program operates like a spreadsheet; the user fills in values for the building, and the computer completes the calculations, including all table lookups, and prints out the answers. The results are the same as if you completed the worksheets manually but it is much faster, more convenient, and less prone to arithmetic error. Many design variations can be evaluated very quickly.

*BuilderGuide* is available from the Passive Solar Industries Council. See page 53 for the address. Computer data files containing the information on pages 48-49 are available for 205 locations within the United States. The user can then adjust for local conditions so performance can be evaluated virtually anywhere.

## The Guidelines

Some principles of passive solar design remain the same in every climate. But the important thing about passive solar is that it makes better use of the opportunities in a house's surroundings. So, many fundamental aspects of the passive solar house's design will depend on the conditions in a small local area, and even on the features of the building site itself. Many of the suggestions in this section apply specifically to Rock Springs, Wyoming, but there is also information in each section of the booklet which will be useful in any climate.

Part One introduces *Passive Solar Design Strategies*, and presents the performance potential of several different passive solar systems in the Rock Springs climate. Although in practice many factors will affect actual energy performance, this information will give you a general idea of how various systems will perform in your area.

Part Two discusses the basic concepts of passive solar design and construction: what the advantages of passive solar are, how passive solar relates to other kinds of energy conservation measures, how the primary passive solar systems work, and what the builder's most important considerations should be when evaluating and using different passive solar strategies.

Part Three gives more specific advice about techniques for suntempering, direct gain systems, thermal storage mass walls and sunspaces, and for natural cooling strategies to help offset air-conditioning needs.

The Example Tables in Part Three are also related to Worksheet numbers, so that you can compare them to the designs you are evaluating. For example, the Passive Solar Sunspace Example Case which uses 40% less energy than the Base Case House (page 29) has:

- a Conservation Performance Level of approximately 46,739 Btu/yr-sf,
- an Auxiliary Heat Performance Level of approximately 29,090 Btu/yr-sf, and
- a Summer Cooling Performance Level of 1,451 Btu/yr-sf.

(In this example, the energy savings are achieved by increasing insulation about 15% over the Base Case, adding a sunspace with south glazing area equal to 8% of the house's floor area, and using a ceiling fan to cut some of the air conditioning load.)

A Base Case house is compared with a series of Example cases to illustrate exactly how these increased levels of energy-efficiency might be achieved.

The Base Case House is a reasonably energy-efficient house based on a 1987 National Association of Home Builders study of housing characteristics, divided into seven different regions. The Base Case used for Rock Springs, Wyoming is from the greater than 7,000 heating degree days region. The house is assumed to be built over an unheated basement, because this is typical in Wyoming.

The examples show how to achieve 20, 40 and 60% energy-use reductions using three basic strategies:

- **Added Insulation:** increasing insulation levels without adding solar features.
- **Suntempering:** increasing south-facing glazing to a maximum of 7% of the house's total floor area, but without adding thermal mass (energy storage) beyond what is already in the framing, standard floor coverings and gypsum wall-board and ceiling surfaces. Insulation levels are also increased.

■ **Passive Solar:** using three different design approaches: Direct Gain, Sunspace, and Thermal Storage Wall, and increased levels of insulation.

For all strategies, the energy savings indicated are based on the assumption that the energy-efficient design and construction guidelines have been followed, so the houses are properly sited and tightly built with high-quality windows and doors.

The Guidelines section has been kept as brief and straightforward as possible, but more detailed information is available if needed. Some references are indicated in the text, and a list of other information sources can be found in the References. Also included at the end of this book are a brief Glossary, a summary of the Example Tables for Rock Springs, Wyoming, and two pages explaining some of the background and assumptions behind the Guidelines and Worksheets called Technical Basis for the Builder Guidelines.

### **The Worksheets**

The Worksheets are specifically tailored for Rock Springs, Wyoming, and are a very important part of this package because they allow you to compare on paper different passive solar strategies or combinations of strategies, and the effect that changes will have on the overall performance of the house.

The most effective way to use the Worksheets is to make multiple copies before you fill them out the first time. You can then use the Worksheets to calculate several different designs. For instance, you could first calculate the performance of the basic house you build now, then fill out Worksheets for that house plus added insulation plus a sunspace, and then for a third possibility such as a Thermal Storage Wall.

The Worksheets provide a way to calculate quickly and with reasonable accuracy how well a design is likely to perform in four key ways: how well it will conserve heat energy; how much the solar features will contribute to its total heating energy needs; how comfortable the house will be; and how much the house's annual cooling load (need for air conditioning) will be.

The Worksheets are supported by "look-up" tables containing pre-calculated factors and numbers for the local area. Some of the blanks in the Worksheets call for information about the house — for example, floor area, projected area of passive solar glazing, and so forth. Other blanks require a

number from one of the tables — for example, from the Solar System Savings Fraction table or from the Heat Gain Factor table.

The Worksheets allow calculation of the following performance indicators:

■ **Worksheet I: Conservation Performance Level:** determines how well the house's basic energy conservation measures (insulation, sealing, caulking, etc.) are working to prevent unwanted heat loss in the winter. The bottom line of this

Worksheet is a number measuring heat loss in British thermal units per square foot per year (Btu/sf-yr) — the lower the heat loss, the better.

■ **Worksheet II: Auxiliary Heat Performance Level:** determines how much heat has to be supplied (that is, provided by the heating system) after taking into account the heat contributed by passive solar. This worksheet arrives at a number estimating the amount of heating energy the house's non-solar heating system has to provide in Btu/yr-sf. Again, the lower, the better.

■ **Worksheet III: Thermal Mass/Comfort:** determines whether the house has adequate thermal mass to assure comfort and good thermal performance. Worksheet III calculates the number of degrees the temperature inside the house is likely to vary, or "swing", during a sunny winter day without the heating system operating. A well-designed house should have a temperature swing of no more than 13 degrees, and the less the better.

■ **Worksheet IV: Summer Cooling Performance Level:** indicates how much air conditioning the house will need in the summer (it is not, however, intended for use in sizing equipment, but as an indication of the reductions in annual cooling load made possible by the use of natural cooling). The natural cooling guidelines should make the house's total cooling load — the bottom line of this Worksheet, in Btu/yr-sf — smaller than in a "conventional" house.

So, the Worksheets provide you with four key numbers indicating the projected performance of the various designs you are evaluating.

■ **The Worked Example:** To assist in understanding how the design strategies outlined in the Guidelines affect the overall performance of a house, a worked example is included. The example house, constructed of materials and design elements typical of the area, is a one story, single-family 1500 sf passive solar design. Various design features, such as direct gain spaces, sunspaces, increased levels of insulation and thermal mass, are included to illustrate the effects combined systems have on the performance of a house. Also, many features are covered to demonstrate how various conditions and situations are addressed in the worksheets. A description of the design features, along with the house plans, elevations and sections, are included for additional support information.

## 2. Passive Solar Performance Potential

The energy performance of passive solar strategies varies significantly, depending on climate, the specific design of the system, and the way it is built and operated. Of course, energy performance is not the only consideration. A system which will give excellent energy performance may not be as marketable in your area or as easily adaptable to your designs as a system which saves less energy but fits your other needs.

In the following table, several different passive solar systems are presented along with two numbers which indicate their performance. The **Percent Solar Savings** is a measure of how much the passive solar system is reducing the house's need for purchased energy. For example, the Percent Solar Savings for the Base Case is 7.7%, because even in a non-solar house, the south-facing windows are contributing some heat energy.

The **Yield** is the annual net heating energy benefit of adding the passive solar system, measured in Btu saved per year per square foot of additional south glazing.

The figures given are for a 1,500 sf, single-story house with a basement. The Base Case has 45 sf of south-facing glazing. For the purposes of this example, the Suntempered house has 100 sf of south-facing glass, and each passive solar system has 145 sf.

The energy savings presented in this example assume that all the systems are designed and built according to the suggestions in these Guidelines. It's also important to remember that the figures below are for annual net *heating* benefits. The natural cooling section in Part Three gives advice about shading and other techniques which would make sure the winter heating benefits are not at the expense of higher summer cooling loads.

Please note that throughout the Guidelines and Worksheets the glazing areas given are for the actual *net* area of the glass itself. A common rule of thumb is that the net glass area is 80 percent of the rough frame opening. For example, if a south glass area of 100 sf is desired, the required area of the rough frame opening would be about 125 sf.

**Performance Potential of Passive Solar Strategies  
In Rock Springs, Wyoming**

1,500 sf, Single Story House

Case	Percent Solar Savings	Yield Btu Saved per Square Foot of South Glass
<b>Base Case</b> (45 sf of south-facing double glass)	7.7	not applicable
<b>Sunt tempered</b> (100 sf of south-facing double glass)	15.7	99,148
<b>Direct Gain</b> (145 sf of south glass)		
Double Glass	21.3	92,563
Triple or low-e glass	23.5	114,327
Double glass with R-4 night insulation <sup>1</sup>	26.6	139,059
Double glass with R-9 night insulation <sup>1</sup>	27.9	148,502
<b>Sunspace</b> (145 sf of south glass)		
Attached with opaque end walls <sup>2</sup>	21.4	100,314
Attached with glazed end walls <sup>2</sup>	20.6	93,738
Semi-enclosed with vertical glazing <sup>3</sup>	22.3	103,394
Semi-enclosed with 50° sloped glazing <sup>3</sup>	27.8	147,658
<b>Thermal Storage Wall — Masonry/Concrete</b> (145 sf of south glass)		
Black surface, double glazing	20.6	92,297
Selective surface, single glazing	27.5	146,454
Selective surface, double glazing	26.9	142,229
<b>Thermal Storage Wall — Water Wall</b> (145 sf of south glass)		
Selective surface, single glazing	31.6	177,300

1. Night insulation is assumed to cover the south glass each night and removed when sun is available. Experience has shown that many homeowners find this inconvenient and so the potential energy savings are often not achieved. Using low-e or other energy-efficient glazing is more reliable.

2. The attached sunspace is assumed to have, in addition to glazed walls, roof glazing at a slope of 30 degrees from the horizontal, or a 7:12 pitch. (See diagram SSB1 in the Worksheets.)

3. The semi-enclosed sunspace has only the south wall exposed to the out-of-doors. The glazing has a slope of 50° from the horizontal, or a 14:12 pitch. The side walls are adjacent to conditioned space in the house. (See diagram SSD1 in the Worksheets.)

## **Part Two: Basics of Passive Solar**

- 1. Why Passive Solar? More than a Question of Energy**
- 2. Key Concepts: Energy Conservation, Suntempering, Passive Solar**
- 3. Improving Conservation Performance**
- 4. Mechanical Systems**
- 5. South-Facing Glass**
- 6. Thermal Mass**
- 7. Orientation**
- 8. Site Planning for Solar Access**
- 9. Interior Space Planning**
- 10. Putting it Together: The House as a System**

## 1. Why Passive Solar? More than a Question of Energy

Houses today are more energy-efficient than ever before. However, the vast majority of new houses still ignore a lot of energy saving opportunities — opportunities available in the sunlight falling on the house, in the landscaping, breezes and other natural elements of the site, and opportunities in the structure and materials of the house itself, which, with thoughtful design, could be used to collect and use free energy. Passive solar (the name distinguishes it from "active" or mechanical solar technologies) is simply a way to take maximum advantage of these opportunities.

Home buyers are also increasingly sophisticated about energy issues, although the average home buyer is probably much more familiar with insulation than with passive solar. The "energy crisis" may be temporarily over, but very few people perceive their own household energy bills as getting smaller — quite the opposite. So a house with significantly lower monthly energy costs year-round will have a strong market advantage over a comparable house down the street, no matter what international oil prices may be.

But there are many different ways to reduce energy bills, and some are more marketable than others. For instance, adding insulation can markedly improve

energy-efficiency — but added insulation is invisible to the prospective home buyer. A sunny, open living area lit by south-facing windows, on the other hand, may be a key selling point. Windows in general are popular with homebuyers, and passive solar can make windows energy *producers* instead of energy liabilities.

Another example: high-efficiency heating equipment can account for significant energy savings — but it won't be as much fun on a winter morning as breakfast in a bright, attractive sunspace.

The point is not that a builder should choose passive solar *instead* of other energy-conserving measures. The important thing is that passive solar can *add* not only energy-efficiency, but also very saleable amenities — style, comfort, attractive interiors, curb appeal and resale value.

In fact, in some local markets, builders report that they don't even make specific reference to "passive solar".

They just present their houses as the state of the art in energy-efficiency and style, and they use passive solar as a part of the package

The U. S. Department of Energy and the Solar Energy Research Institute (SERI) conducted extensive national surveys of passive solar homes, home owners and potential buyers. Some key findings:

- **passive solar homes work** — they generally require an average of about 30% less energy for heating than "conventional" houses, with some houses saving much more.
- **occupants of passive solar homes are pleased** with the performance of their homes (over 90% "very satisfied"), but they rank the comfort and pleasant living environment as just as important (in some regions, more important) to their satisfaction, and in their decision to buy the house, as energy considerations.
- **passive solar home owners and lenders perceive the resale value of passive solar houses as high.**

### Advantages of Passive Solar

- **Energy performance:** Lower energy bills all year-round
- **Attractive living environment:** large windows and views, sunny interiors, open floor plans
- **Comfort:** quiet (no operating noise), solid construction, warmer in winter, cooler in summer (even during a power failure)
- **Value:** high owner satisfaction, high resale value
- **Low Maintenance:** durable, reduced operation and repairs
- **Investment:** independence from future rises in fuel costs, will continue to save money long after any initial costs have been recovered
- **Environmental Concerns:** clean, renewable energy to combat growing concerns over global warming, acid rain and ozone depletion

## 2. Key Concepts: Energy Conservation, Suntempering, Passive Solar

The strategies for enhancing energy performance which are presented here fall into three general categories:

- **Energy Conservation:** insulation levels, control of air infiltration, glazing type and location and mechanical equipment.
- **Suntempering:** a limited use of passive solar techniques; modestly increasing south-facing window area, usually by relocating windows from other sides of the house, but without adding thermal mass.
- **Passive Solar:** going beyond conservation and suntempering to a complete system of collection, storage and use of solar energy: using more south glass, adding significant thermal mass, and taking steps to control and distribute heat energy throughout the house.

What is immediately clear is that these categories overlap. For instance, a good energy-conservation package is the necessary starting point of *all* well-designed suntempered and passive solar houses. There's no use collecting solar energy if it is immediately lost through leaky windows or poorly insulated walls.

In the same way, many of the measures that are often considered part of suntempering or passive solar — such as orienting to take advantage of summer breezes, or landscaping for natural cooling, or facing a long wall of the house south — can help a house conserve energy even if no "solar" features are planned.

The essential elements in a passive solar house are **south-facing glass** and **thermal mass**.

In the simplest terms, a passive solar system collects solar energy through south-facing glass and stores solar energy in thermal mass — materials with a high capacity for storing heat (e.g., brick, concrete masonry, concrete slab, tile, water). The more south-facing glass is used in the house, the more thermal mass must be provided, or the house will overheat and the solar system will not perform as expected.

With too much glass and/or insufficient mass, solar energy can work *too* well, and the house can be uncomfortably hot even on a winter day.

Although the concept is simple, in practice the relationship between the amount of glazing and the amount of mass is complicated by many factors, and has been a subject of considerable study and experiment. From a comfort and energy standpoint, it would be difficult to add too much mass. Thermal mass will hold warmth longer in winter and keep houses cooler in summer. But thermal mass has a cost, and so adding too much mass for just thermal storage purposes can be unnecessarily expensive.

The following sections of the Guidelines discuss the size and location of glass and mass, as well as other considerations which are basic to both suntempered and full passive solar houses: improving conservation performance; mechanical systems; orientation; site planning for solar access; interior space planning; and taking an integrated approach to the house as a total system.



### 3. Improving Conservation Performance

The techniques described in this section relate to **Worksheet I: Conservation Performance Level**, which measures the house's heat loss. The energy conservation measures that reduce heat loss also tend to reduce the house's need for air conditioning.

The most important measures for improving the house's basic ability to conserve the heat generated either by the sun or by the house's conventional heating system are in the following areas:

- **Insulation**
- **Air infiltration**
- **Non-solar glazing**

#### **Insulation**

Adding insulation to walls, floors, ceilings, roof and foundation improves their thermal resistance (R-value) — their resistance to heat flowing out of the house.

A quality job of *installing* the insulation can have almost as much effect on energy performance as the R-value, so careful construction supervision is important. An inspection just before the drywall is hung identifies improvements which are easy at that time but will make a big difference in the energy use of the home for years to come.

The thermal resistance of **ceiling/roof assemblies, walls and floors** is affected not only by the R-value of the insulation itself, but also the resistance of other elements in the construction assembly — framing effects, sheathing, interior drywall, and so on. The Worksheets include tables that show Equivalent Construction R-Values which account for these and other effects. For instance, ventilated crawlspaces and unheated basements provide a buffering effect which is accounted for in the Worksheet tables.

With attics, framing effects are minimized if the insulation covers the ceiling trusses, either by using blown-in insulation or by running an additional layer of batts in the opposite direction of the ceiling joists. Ridge and/or eave vents are needed for ventilation.

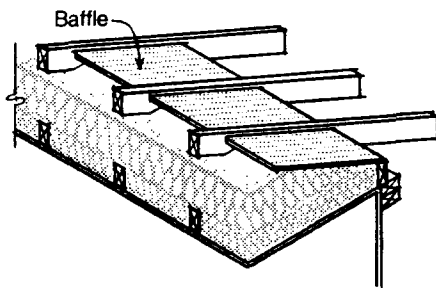

**Insulation in an Attic**  
Insulation should extend over the top ceiling joists and ventilation should be provided at the eaves.

In framed ceiling/roof assemblies, an insulating sheathing over the top decking will increase the R-value.

**Slab edge insulation** should be at least two feet deep, extending from the surface of the floor. Materials for slab edge insulation should be selected for underground durability. One material with a proven track record is extruded polystyrene. Exposed insulation should be protected from physical damage by attaching a protection board, for instance, or by covering the insulation with a protective surface.

**Heated basement walls** should be fully insulated to at least four feet below grade, but the portion of the wall below that depth only needs to be insulated to about half the R-value of the upper portion. Insulation can be placed on the outside surface of the wall, or on the inside surface of the wall, or in the cores of the masonry units.

If the basement walls are insulated on the outside, the materials should be durable underground, and exposed insulation should be protected from damage. In the case of a finished basement or walk-out basement, placing insulation on the interior may be less costly than insulating the exterior foundation.

### **Air Infiltration**

Sealing the house carefully to reduce air infiltration — air leakage — is as necessary to energy conservation as adding insulation. Air will flow rapidly through cracks and crevices in the wall, in the same way water flows through the drain in a bathtub, so even a small opening can allow heat to bypass the insulation and lead to big energy losses.

The tightness of houses is generally measured in the number of air changes per hour (ACH). A good, comfortable, energy-efficient house, built along the guidelines in the table on this page, will have approximately 0.35 to 0.50 air changes per hour under normal winter conditions.

Increasing the tightness of the house beyond that may improve the energy performance, but it may also create problems with indoor air quality, moisture build-up, and inadequately vented fireplaces and furnaces. Some kind of additional mechanical ventilation — for example, small fans, heat pump heat exchangers, integrated ventilation systems or air-to-air heat exchangers — will probably be necessary to avoid such problems in houses with less than 0.35 ACH (calculated or measured).

The use of house sealing subcontractors to do the tightening and check it with a blower door can often save the builder time and problems, especially when trying to achieve particularly high levels of infiltration control.

#### **Checklist for Minimizing Air Leakage**

- ✓ Tighten seals around windows and doors, and weatherstripping around all openings to the outside or to unconditioned rooms;
- ✓ Caulk around all windows and doors before drywall is hung; seal all penetrations (plumbing, electrical, etc.);
- ✓ Insulate behind wall outlets and/or plumbing lines in exterior walls;
- ✓ Caulk under headers and sills;
- ✓ Chink spaces between rough openings and millwork with insulation, or for a better seal, fill with foam;
- ✓ Seal larger openings such as ducts into attics or crawlspaces with taped polyethylene covered with insulation;
- ✓ Locate continuous vapor retardants located on the warm side of the insulation (building wrap, continuous interior polyethylene, etc.);
- ✓ Install dampers and/or glass doors on fireplaces; combined with outside combustion air intake;
- ✓ Install backdraft dampers on all exhaust fan openings;
- ✓ Caulk and seal the joint between the basement slab (or the slab on grade) and the basement wall;
- ✓ Remove wood grade stakes from slabs and seal;
- ✓ Cover and seal sump cracks;
- ✓ Close core voids in top of block foundation walls;
- ✓ Control concrete and masonry cracking;
- ✓ Use of air tight drywall methods are also acceptable (see Reference 11);
- ✓ Employ appropriate radon mitigation techniques (see Reference 12).

### **Non-Solar Glazing**

South-facing windows are considered solar glazing. The south windows in *any* house are contributing some solar heat energy to the house's heating needs — whether it's a significant, usable amount or hardly worth measuring will depend on design, location and other factors which are dealt with later under the discussions of suntempering and passive solar systems.

North windows in almost every climate lose significant heat energy and gain very little useful sunlight in the winter. East and west windows are likely to increase air conditioning needs unless heat gain is minimized with careful attention to shading.

But most of the reasons people want windows have very little to do with energy, so the best design will probably be a good working compromise between efficiency and other benefits, such as bright living spaces and views.

Triple-glazing or double-glazing with a low-e coating is advisable. Low-e glazing on all non-solar windows may be an especially useful solution because some low-e coatings can insulate in winter and shield against unwanted heat gain in summer.

Manufacturers will provide actual R-values for their windows (the thermal performance of glazing can be expressed either as an R-value or its reciprocal, U-value; here all thermal performance values are given in terms of R-value). A chart is also provided with the Worksheets to show approximate window R-values for various types. (the Equivalent Glazing R-Value pertains to the entire rough frame opening of the window.)

**North** windows should be used with care. Sometimes views or the diffuse northern light are desirable, but in general north-facing windows should not be large. Very large north-facing windows should have high insulation value, or R-value. Since north windows receive relatively little direct sun in summer, they do not present much of a shading problem. So if the choice were between an average-sized north-facing window and an east or west-facing window, north would actually be a better choice, considering both summer and winter performance.

**East** windows catch the morning sun. Not enough to provide significant energy, but, unfortunately, usually enough to cause potential overheating

problems in summer. If the views or other elements in the house's design dictate east windows, shading should be done with particular care.

**West** windows may be the most problematic, and there are few shading systems that will be effective enough to offset the potential for overheating from a large west-facing window. Glass with a low shading coefficient may be one effective approach — for example, tinted glass or some types of low-e glass which provide some shading while allowing almost clear views. The cost of properly shading both east and west windows should be balanced against the benefits.

As many windows as possible should be kept operable for easy natural ventilation in summer. (See also Orientation, page 1<sup>6</sup>, Recommended Non-South Glass Guidelines, page 3<sup>4</sup>, and Shading, page 3.<sup>7</sup>)

## 4. Mechanical Systems

The passive solar features in the house and the mechanical heating, ventilating and air conditioning systems (HVAC) will interact all year round and so the most effective approach will be to design the system as an integrated whole. HVAC design is, of course, a complex subject, but the three areas below are particularly worth noting in passive solar houses:

■ **System Sizing.** Mechanical systems are often oversized for the relatively low heating loads in well-insulated passive solar houses. Oversized systems will cost more in the first place, and will cycle on and off more often, wasting energy. The back-up systems in passive solar houses should be sized to provide 100% of the heating or cooling load on the design day, *but no larger*. Comparing estimates on system sizes from more than one contractor is probably a good idea.

■ **Night Setback.** Clock thermostats for automatic night setback are usually very effective — but in passive solar systems with large amounts of thermal mass (and thus a large capacity for storing energy and releasing it during the night), night setback of the thermostat may not save very much energy.

■ **Ducts.** One area often neglected but of key importance to the house's energy performance is the design and location of the ducts. Both the supply and return ducts should be located within insulated areas, or well insulated if they run in cold areas of the house, and well sealed at the joints. The joints where the ducts turn up into exterior walls or penetrate the ceiling should be particularly tight and caulked.

In the National Association of Home Builders' Energy-Efficient House Project, all the rooms were fed with low, central air supplies, as opposed to the usual placement of registers under windows at the end of long runs. This resulted in good comfort and energy performance.

The performance of even the most beautifully designed passive solar house can easily be undermined by details like uninsulated ducts, or by overlooking other basic energy conservation measures.

## 5. South-Facing Glass

South-facing solar glass is a key component of any passive solar system. The system must include enough solar glazing for good performance in winter, but not so much that cooling performance in summer will be compromised. The amount of solar glazing must also be carefully related to the amount of thermal mass. Suntempered houses require no additional thermal mass beyond that already in the wallboard, framing and furnishings of a typical house. *Passive solar houses must have additional thermal mass.*

There are three types of limits on the amount of south-facing glass that can be used effectively in a house. The first is a limit on the amount of glazing for suntempered houses. This limit (without adding thermal mass) is 7% of the house's total floor area.

For direct gain systems in passive solar houses, the maximum amount of south-facing glazing is 12% of total floor area, regardless of how much additional thermal mass is provided. Further details about the most effective sizing of south glass and thermal mass for direct gain systems are provided in Part Three.

The third limit on south-facing glass is the total of all passive solar systems combined, which should not exceed 20% of total floor area. Using more south glass than this limit could lead to overheating even in winter.

For example, a passive solar system for a 1,500 sf house might combine 150 sf of direct gain glazing with 120 sf of sunspace glazing for a total of 270 sf of solar glazing, or 18% of the total floor area, well within the direct gain limit of 12% and the overall limit of 20%. For a design like this, thermal mass would be required both in the house and within the sunspace.

The Natural Cooling guidelines in Part Three include recommendations on the window area that should be operable to allow for natural ventilation.

When the solar glazing is tilted, its winter effectiveness as a solar collector usually increases. However, tilted glazing can cause serious overheating in the summer if it is not shaded very carefully. Ordinary vertical glazing is easier to shade, less likely to overheat, less susceptible to damage and leaking, and so is almost always a better year-round solution. Even in the winter, with the sun low in the sky and reflecting off snow cover, vertical glazing can often offer energy performance just as effective as tilted.

## 6. Thermal Mass

Some heat storage capacity, or thermal mass, is present in all houses, in the framing, gypsum wall and ceiling board, typical furnishings and floor coverings. In suntempered houses, this modest amount of mass is sufficient for the modest amount of south-facing glass. But more thermal mass is required in passive solar houses, and the question is not only how much, but what kind and where it should be located.

The thermal mass in a passive solar system is usually a conventional construction material such as brick, cast concrete, concrete masonry, concrete slabs, or tile, and is usually placed in the floor or interior walls. Other materials can also be used for thermal mass, such as "phase change" materials, which store and release heat through a chemical reaction. Water actually has a higher unit thermal storage capacity than concrete or masonry. Water tubes and units called "water walls" are commercially available (general recommendations for these systems are included in the section on Thermal Storage Wall systems).

The thermal storage capabilities of a given material depend on the material's conductivity, specific heat and density. Most of the concrete and masonry materials typically used in passive solar have similar specific heats. Conductivity tends to increase with increasing density. So the major factor affecting performance is density. Generally, the higher the density the better.

The design issues related to thermal mass depend on the passive system type. For sunspaces and thermal storage wall systems, the required mass of the system is included in the design itself. For direct gain, the added mass must be within the rooms receiving the sunlight. The sections on Direct Gain Systems, Sunspaces and Thermal Storage Walls contain more information on techniques for sizing and locating thermal mass in those systems.

Heat Storage Properties of Materials		
Material	Density (lb/ft <sup>3</sup> )	Heat Capacity (Btu/in-sf-°F)
Poured Concrete	120 - 150	2.0 - 2.5
Clay Masonry		
Molded Brick	120 - 130	2.0 - 2.2
Extruded Brick	125 - 135	2.1 - 2.3
Pavers	130 - 135	2.2 - 2.3
Concrete Masonry		
Block	80 - 140	1.3 - 2.3
Brick	115 - 140	1.9 - 2.3
Pavers	130 - 150	2.2 - 2.5
Gypsum Wallboard	50	0.83
Water	62.4	5.2

## 7. Orientation

The *ideal* orientation for solar glazing is within 5 degrees of true south. This orientation will provide maximum performance. Glazing oriented to within 15 degrees of true south will perform almost as well, and orientations up to 30 degrees off — although less effective — will still provide a substantial level of solar contribution.

In Rock Springs, magnetic north as indicated on the compass is actually 16 degrees east of true north, and this should be corrected for when planning for orientation of south glazing.

When glazing is oriented more than 15 degrees off true south, not only is winter solar performance reduced, but summer air conditioning loads also significantly increase, especially as the orientation goes west. The warmer the climate, the more east- and west-facing glass will tend to cause overheating problems. In general, southeast orientations present less of a problem than southwest.

In the ideal situation, the house should be oriented east-west and so have its longest wall facing south. But as a practical matter, if the house's short side has good southern exposure it will usually accommodate sufficient glazing for an effective passive solar system, provided the heat can be transferred to the northern zones of the house.

## 8. Site Planning for Solar Access

The basic objective of site planning for maximum energy performance is to allow the south side as much unshaded exposure as possible during the winter months.

As discussed above, a good solar orientation is possible within a relatively large southern arc, so the flexibility exists to achieve a workable balance between energy performance and other important factors such as the slope of the site, the individual house plan, the direction of prevailing breezes for summer cooling, the views, the street lay-out, and so on.

But planning for solar access does place some restrictions even on an individual site, and presents even more challenges when planning a complete subdivision. Over the years, developers and builders of many different kinds of projects all over the country have come up with flexible ways to provide adequate solar access.

Once again, there is an ideal situation and then some degree of flexibility to address practical concerns. Ideally, the glazing on the house should be exposed to sunlight with no obstructions within an arc of 60 degrees on either side of true south, but reasonably good solar access will still be guaranteed if the glazing is unshaded within an arc of 45 degrees. The figure on this page shows the optimum situation for providing unshaded southern exposure during the winter. See

also the figure on page 35 showing landscaping for summer shade.

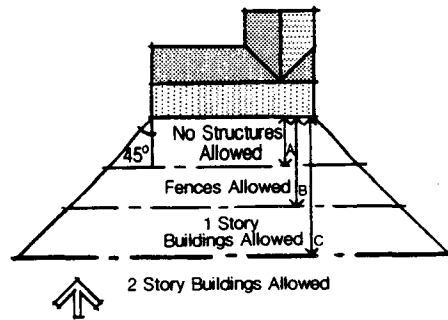

**Ideal Solar Access**  
Buildings, trees or other obstructions should not be located so as to shade the south wall of solar buildings. At this latitude, A = 15 ft., B = 26 ft., and C = 60 ft.

Of course, not all lots are large enough to accommodate this kind of optimum solar access, so it's important to carefully assess shading patterns on smaller lots to make the best compromise.

Protecting solar access is easiest in subdivisions with streets that run within 25 degrees of east-west, because all lots will either face or back up to south. Where the streets run north-south, creation of east-west cul-de-sacs will help ensure solar access.

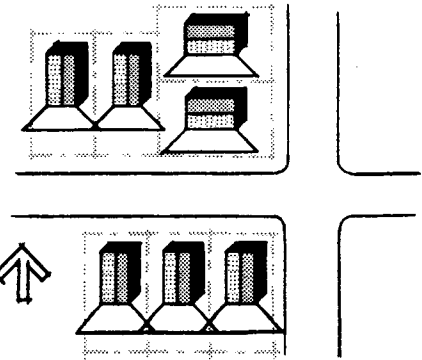

**Solar Subdivision Layouts**  
Solar access may be provided to the rear yard, the side yard or the front yard of solar homes.

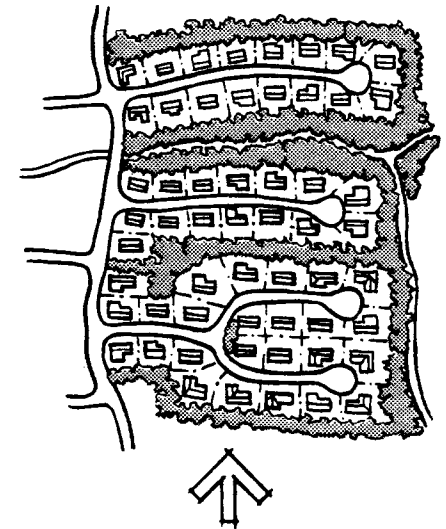

**Solar Subdivision Layouts**  
Short east-west cul-de-sacs tied into north-south collectors is a good street pattern for solar access.

Two excellent references for ideas about subdivision lay-out to protect solar access are *Builder's Guide to Passive Solar Home Design and Land Development and Site Planning for Solar Access*. (See References 15 and 16).



## 9. Interior Space Planning

Planning room lay-out by considering how the rooms will be used in different seasons, and at different times of day, can save energy and increase comfort. In houses with passive solar features, the lay-out of rooms — and interior zones which may include more than one room — is particularly important.

In general, living areas and other high-activity rooms should be located on the south side to benefit from the solar heat. The closets, storage areas, garage and other less-used rooms can act as buffers along the north side, but entry-ways should be located away from the wind. Clustering baths, kitchens and laundry-rooms near the water heater will save the heat that would be lost from longer water lines.

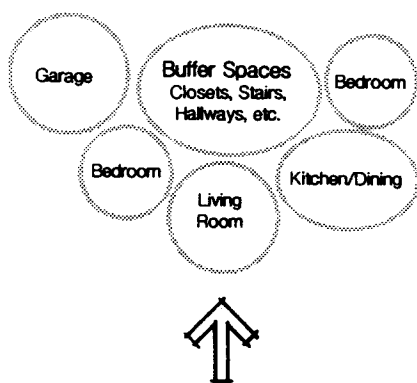

**Interior Space Planning**  
Living and high activity spaces should be located on the south.

Another general principle is that an open floor plan will allow the collected solar heat to circulate freely through natural convection.

Other ideas from effective passive solar houses:

- Orienting internal mass walls as north-south partitions that can be "charged" on both sides thus making maximum use of the mass.
- Using an east-west partition wall for thermal mass, but make sure the interior space isn't divided into a south zone which may get too warm and a north zone which may get too cold.
- Using thermal storage walls (see page 30); the walls store energy all day and slowly release it at night, and can be a good alternative to ensure privacy and to buffer noise when the south side faces the street;
- Collecting the solar energy in one zone of the house and transporting it to another by fans or natural convection through an open floor plan.
- Providing south-facing clerestories to "charge" north zones.

## 10. Putting it Together: The House as a System

Many different factors will affect a house's overall performance, and these factors all interact: the mechanical system, the insulation, the house's tightness, the effects of the passive solar features, the appliances, and, very importantly, the actions of the people who live in the house. In each of these areas, changes are possible which would improve the house's energy performance. Some energy savings are relatively easy to get. Others can be more expensive and more difficult to achieve, but may provide benefits over and above good energy performance.

**A sensible energy-efficient house uses a combination of techniques.**

In fact, probably the most important thing to remember about designing for energy performance in a way that will also enhance the comfort and value of the house is to take an integrated approach, keeping in mind the house as a total system. On the the following page is a basic checklist for energy-efficient design. These techniques are dealt with in more detail, including their impact in your location, in Part Three.

### Checklist for Good Design

- ✓ **1. Building orientation:** A number of innovative techniques can be used for obtaining good solar access on less-than-ideal sites (see References 15 and 16). No matter what the house's design, and no matter what the site, some options for orientation will be more energy-efficient than others, and even a very simple review of the site will probably help you choose the best option available.
- ✓ **2. Upgraded levels of insulation:** It is possible, of course, to achieve very high energy-efficiency with a "superinsulated" design. But in many cases, one advantage of passive solar design is that energy-efficiency can be achieved with more modest increases in insulation.  
On the other hand, if very high energy performance is a priority — for example, in areas where the cost of fuel is high — the most cost-effective way to achieve it is generally through a combination of high levels of insulation and passive solar features.
- ✓ **3. Reduced air infiltration:** Air tightness is not only critical to energy performance, but it also makes the house more comfortable.  
Indoor air quality is an important issue, and too complex for a complete discussion here, but in general, the suntempered and passive solar houses built according to the guidelines provide an alternative approach to achieving improved energy efficiency without requiring air quality controls such as air to air heat exchangers, which would be needed if the house were made extremely airtight.
- ✓ **4. Proper window sizing and location:** Even if the total amount of glazing is not changed, rearranging the location alone can often lead to significant energy savings at little or no added cost. Some energy-conserving designs minimize window area on all sides of the house — but it's a fact of human nature that people like windows, and windows can be energy producers if located correctly.
- ✓ **5. Selection of glazing:** Low-emissivity (low-e) glazing types went from revolutionary to commonplace in a very short time, and they can be highly energy-efficient choices. But the range of glazing possibilities is broader than that, and the choice will have a significant impact on energy performance. Using different types of glazing for windows with different orientations is worth considering for maximum energy performance; for example, using heat-rejecting glazing on west windows, high R-value glazing for north and east windows, and clear double-glazing on solar glazing.
- ✓ **6. Proper shading of windows:** If windows are not properly shaded in summer — either with shading devices, or by high-performance glazing with a low shading coefficient — the air conditioner will have to work overtime and the energy savings of the winter may be canceled out. Even more important, unwanted solar gain is uncomfortable.
- ✓ **7. Interior design for easy air distribution:** If the rooms in the house are planned carefully, the flow of heat in the winter will make the passive solar features more effective, and the air movement will also enhance ventilation and comfort during the summer. Often this means the kind of open floor plan which is highly marketable in most areas. Planning the rooms with attention to use patterns and energy needs can save energy in other ways, too — for instance, using less-lived-in areas like storage rooms as buffers on the north side.
- ✓ **8. Addition of thermal mass:** Adding effective thermal mass — for example, tiled or paved concrete slab, masonry walls, brick fireplaces, tile floors, etc. — can greatly improve the comfort in the house, holding heat better in winter and keeping rooms cooler in summer. In a passive solar system, of course, properly sized and located thermal mass is essential.
- ✓ **9. Selection and proper sizing of mechanical systems, and selection of energy-efficient appliances:** High-performance heating, cooling and hot water systems are extremely energy-efficient, and almost always a good investment. Mechanical equipment should have at least a 0.80 Annual Fuel Utilization Efficiency (AFUE).  
Well-insulated passive solar homes will have much lower energy loads than conventional homes, and should be sized accordingly. Oversized systems will cost more and reduce the house's performance.  
For guides to the selection of energy-efficient appliances, see References 13 and 14.



## **Part Three: Strategies for Improving Energy Performance in Rock Springs, Wyoming**

- 1. The Example Tables**
- 2. Suntempering**
- 3. Direct Gain**
- 4. Sunspaces**
- 5. Thermal Storage Wall**
- 6. Combined Systems**
- 7. Natural Cooling Guidelines**

## 1. The Example Tables

In the following sections of the Guidelines, the primary passive solar systems — Suntempering, Direct Gain, Thermal Storage Walls and Sunspaces — are described in more detail.

As part of the explanation of each system, an Example table is provided. The Examples present the following information about a Base Case house, based on a National Association of Home Builders study of a typical construction:

- Insulation levels (ceilings, walls, floors);
- Insulation added to the perimeter of the basement walls;
- Tightness (measured in air changes per hour, ACH);
- The amount of glass area on each side (measured as a percentage of floor area; the actual square footage for a 1,500 sf house is also given as a reference point);
- The "percent solar savings" (the part of a house's heating energy saved by the solar features); and

■ Three numbers corresponding to those on the Worksheets: Conservation, Auxillary Heat, and Cooling Performance (see page 4) The Example tables then show how the house design could be changed to reduce winter heating energy by 20, 40 and 60%, compared to this Base Case.

There are, of course, other ways to achieve energy savings than those shown in the Examples. The Examples are designed to show an effective integration of strategies, and a useful approach to the design of the house as a total system. Using any of these combinations would result in excellent performance in your area. However, they are general indications only, and using the Worksheets will give you more information about your specific design.

The Example assumes a 1,500 sf house, but the percentages apply to a house of any size or configuration.

The R-values indicated in the Example tables are, of course, approximate and are intended to show how incremental improvements can be achieved. All R-values in the Examples and Worksheets are equivalent R-values for the entire construction assembly, not just for the cavity insulation itself, and take into account framing and buffering effects.

Other assumptions are noted for each Example. However, one more general assumption is important to note here. When the Examples were calculated, it was assumed that natural cooling strategies such as those described in these Guidelines were used, particularly in the very high-performance systems. The greater the percentage reduction in heating energy needs using passive solar design, the more shading and natural cooling were assumed.

The Examples show passive solar strategies, but an Insulation Only Example table (achieving energy savings only by increasing insulation levels, without solar features) is provided in the Summary beginning on page 42, for comparison.

## 2. Suntempering

Suntempered and passive solar houses **both**:

- begin with good basic **energy-conservation**,
- take maximum advantage of the building site through the right **orientation** for year-round energy savings, and
- have increased **south-facing glass** to collect solar energy.

Suntempering is the simplest passive solar system, and refers to modest increases in windows on the south side.

No additional thermal mass is necessary, only the "free mass" in the house — the framing, gypsum wall-board and furnishings.

In a "conventional" house, about 25% of the windows face south, which amounts to about 3% of the house's total floor area. In a suntempered house, the percentage is increased to a maximum of about 7%.

The energy savings are more modest with this system, but suntempering is a very low-cost strategy.

Of course, even though the necessity for precise sizing of glazing and thermal mass does not apply to suntempering (as long as the total south-facing glass does not exceed 7% of the total house floor area), all other recommendations about energy-efficient design such as the basic energy conservation measures, room lay-out, siting, glazing type and so on are still important for performance and comfort in suntempered homes.

<b>Examples of Heat Energy Savings Suntempered 1,500 sf Single Story House</b>				
	Base Case	20%	40%	60%
<b>R-Values</b>				
Ceiling/Roof	31	34	41	52
Walls	19	21	25	32
Basement Wall	11	12	15	19
Glass	1.8	1.8	1.8	2.7
<b>Air Changes/Hour</b>	0.50	0.46	0.28	0.29
<b>Glass Area (percent of total floor area)</b>				
West	3.0%	2.0%	2.0%	2.0%
North	3.0%	4.0%	4.0%	4.0%
East	3.0%	4.0%	4.0%	4.0%
South	3.0%	6.7%	6.7%	6.7%
<b>Solar System Size (square feet)</b>				
South Glass	45	100	100	100
<b>Percent Solar Savings</b>				
	8%	19%	23%	29%
<b>Performance (Btu/yr-sf)</b>				
Conservation	51,037	47,976	38,198	28,127
Auxiliary Heat	47,085	38,639	29,202	19,741
Cooling	4,555	956	690	0
<b>Summary:</b> Insulation values and tightness of the house (as measured in ACH) have been increased. The window area has been slightly decreased on the west, increased slightly on the east and north, and increased significantly on the south.				

### 3. Direct Gain

The most common passive solar system is called direct gain: sunlight through south-facing glazing falls directly into the space to be heated, and is stored in thermal mass incorporated into the floor or interior walls.

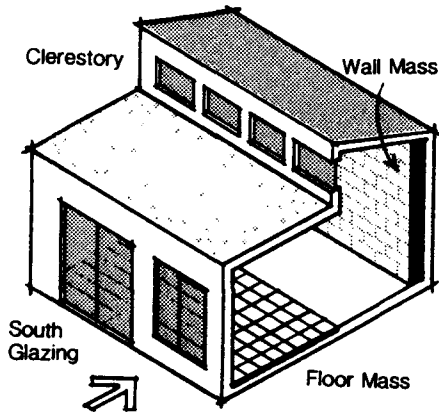

**Direct Gain**  
Direct gain is the most common passive solar system in residential applications

#### Sizing Limit

Total direct gain glass area should not exceed about 12% of the house's floor area. Beyond that, problems with glare or fading of fabrics are more likely to occur, and it becomes more difficult to provide enough thermal mass for year-round comfort.

So the total south-facing glass area in a direct gain system should be between 7% (the maximum for suntempered houses) and 12%, depending on how much thermal mass will be used in the design, as discussed below.

#### Glazing

Double glazing is recommended for direct gain glazing in Rock Springs. The Performance Potential table on page 6 shows the relative performance of different types of direct gain glazing. You will note from this table that yield increases by 23% between double and triple or low-e glazing. Night insulation also improves energy performance dramatically. In fact, as the Performance Potential table shows, covering the windows at night or on cloudy days with the equivalent of R-4 shades or other material will save almost as much energy as with R-9 material. But studies have shown that only relatively few homeowners will be diligent enough about operating their night insulation to achieve those savings. Energy-efficient glazing, on the other hand, needs no operation, and therefore is a more convenient and reliable option.

#### Thermal Mass

Thermal mass can be incorporated easily into slab-on-grade type buildings as either floor covering, walls or veneers over interior walls. If the mass is placed in the floor, it will be much more effective if sunlight falls directly on it.

Effective materials for floors include painted, colored or vinyl-covered concrete, brick (face brick or pavers have even higher density than ordinary building brick), quarry tile, and dark-colored ceramic tile.

For houses built with crawlspaces or basements, the

incorporation of significant amounts of heavy thermal mass is a little more difficult. Thermal mass floor coverings over basements, crawlspaces and lower stories would generally be limited to thin set tile or other thin mass floors.

When more mass is required, the next best option is for interior walls or interior masonry fireplaces. When evaluating costs, the dual function of mass walls should be remembered. They often serve as structural elements or for fire protection as well as for thermal storage. Another option is to switch to another passive solar system type such as attached slab-on-grade sunspaces or thermal storage walls built directly on exterior foundation walls.

Sunlit thermal mass floors should be relatively dark in color, to absorb and store energy more effectively. However, mass walls and ceilings should be light in color to help distribute both heat and light more evenly.

**Ratio of Glass to Mass.** The following procedure can be used to determine the maximum amount of direct-gain glazing for a given amount of thermal mass. If the amount of direct-gain glazing to be used is already known, thermal mass can be added until this procedure produces the desired proportions:

- Start with a direct gain glass area equal to 7% of the house's total floor area. As noted above, the "free mass" in the house will be able to accommodate this much solar energy.
- An additional 1.0 sf of direct gain glazing may be added for every 5.5 sf of *uncovered, sunlit* mass floor. Carpet or area rugs will seriously reduce the effectiveness of the mass. The maximum floor mass that can be considered as "sunlit" may be estimated as about 1.5 times the south window area.
- An additional 1.0 square foot of direct gain glazing may be added for every 40 sf of thermal mass in the floor of the room, but not in the sun.
- An additional 1.0 square foot of direct gain glazing may be added for each 8.3 sf of thermal mass placed in the wall or ceiling of the room. Mass in the wall or ceiling does not have to be located directly in the sunlight, as long as it is in the same room, with no other walls between the mass and the area where the sunlight is falling.

More south-facing glazing than the maximum as determined here would tend to overheat the room, and to reduce energy performance as well.

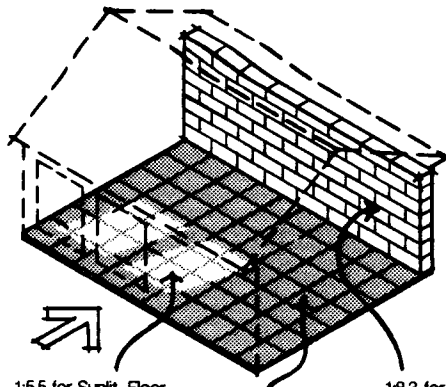

1:5.5 for Sunlit Floor (should not exceed 1.5 times window area)      1:40 for Floor not in Sun      18.3 for Walls & Ceilings

**Mass Location and Effectiveness**  
 Additional mass must be provided for south facing glass over 7% of the floor area. The ratio of mass area to additional glass area depends on its location within the direct gain space.

**Thickness.** For most materials, the effectiveness of the thermal mass in the floor or interior wall increases proportionally with thickness up to about 4 inches. After that, the effectiveness doesn't increase as significantly.

A two-inch mass floor will be about two-thirds as effective in a direct gain system as a four-inch mass floor. But a six-inch mass floor will only perform about eight percent better than a four-inch floor.

The following figure shows the effectiveness of thermal mass in relation to density and thickness. The vertical axis shows how many square feet of mass area are needed for each added square foot of direct gain. As you can see, performance increases start leveling off after a few inches of thermal mass.

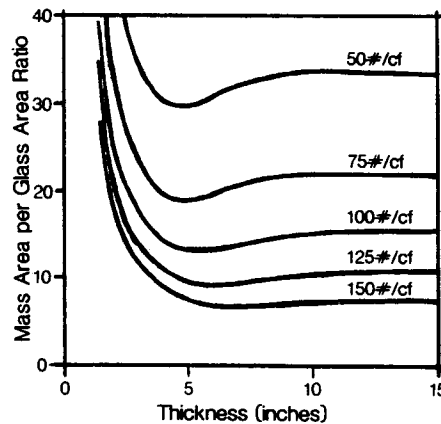

**Mass Thickness**  
 The effectiveness of thermal mass depends on the density of the material and thickness. This graph is for wall or ceiling mass in the direct gain space.

**Worksheet III: Thermal Mass/Comfort** should be used to make sure the house has adequate thermal mass.



**Examples of Heat Energy Savings  
Passive Solar—Direct Gain  
1,500 sf Single Story House**

	Base Case	20%	40%	60%
<b>R-values</b>				
Ceiling/Roof	31	30	37	46
Walls	19	18	23	29
Basement Wall	11	10	14	17
Glass	1.8	1.8	1.8	2.7
<b>Air Changes/Hour</b>	0.50	0.48	0.37	0.34
<b>Glass Area (percent of total floor area)</b>				
West	3.0%	2.0%	2.0%	2.0%
North	3.0%	4.0%	4.0%	4.0%
East	3.0%	4.0%	4.0%	4.0%
South	3.0%	10.5%	11.1%	12.0%
<b>Added Thermal Mass</b>				
Percent of Floor Area	0.0%	20.9%	24.6%	30.0%
<b>Solar System Size (square feet)</b>				
South Glass	45	157	166	180
Added Thermal Mass	0	313	368	450
<b>Percent Solar Savings</b>				
	8%	26%	32%	41%
<b>Performance (Btu/yr-sf)</b>				
Conservation	51,037	52,506	43,158	33,626
Auxiliary Heat	47,085	38,551	29,164	19,696
Cooling	4,555	646	316	0

**Summary:** Insulation and tightness have been increased. South-facing glazing has been substantially increased. For these examples, added mass area is assumed to be six times the excess south glass area.

## 4. Sunspaces

The sunspace is a very popular passive solar feature, adding an attractive living space as well as energy performance. There are many variations on the basic theme of the sunspace, and the possibilities for sunspace design are extraordinarily diverse (References 17 through 20 include specific design ideas).

The sunspace concept used in these Guidelines can be used year-round, will provide most or all of its own energy needs, and will contribute to the energy needs of the rest of the house as well.

Sunspaces are referred to as "isolated gain" passive solar systems, because the sunlight is collected in an area which can be closed off from the rest of the house. During the day, the doors or windows between the sunspace and the house can be opened to circulate collected heat, and then closed at night, and the temperature in the sunspace allowed to drop.

The sunspace should not be on the same heating system as the rest of the house. A well designed sunspace will probably need no mechanical heating system, but if necessary, a small fan or heater may be used to protect plants on extremely cold winter nights.

The sunspace should be just as tightly constructed and insulated as the rest of the house.

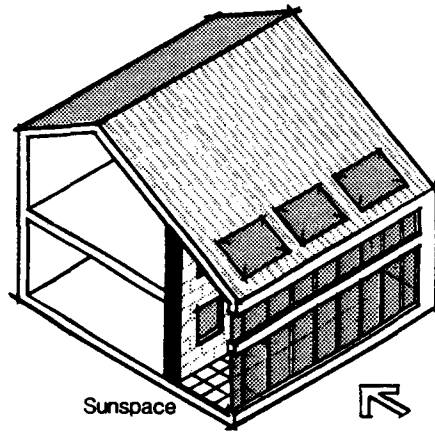

**Sunspaces**  
Sunspaces provide useful passive solar heating and also provide a valuable amenity to homes.

### Thermal Mass

A sunspace has extensive south-facing glass, so sufficient thermal mass is very important. Without it, the sunspace is liable to be uncomfortably hot during the day, and too cold for plants or people at night.

However, the temperature in the sunspace can vary more than in the house itself, so about three square feet of four inch thick thermal mass for each square foot of sunspace glazing should be adequate. With this glass-to-mass ratio, on a clear winter day a temperature swing of about 30°F should be expected.

The sunspace floor is a good location for thermal mass. The mass floors should be dark in color. No more than 15-25% of the floor slab should be covered with rugs or plants. The lower edge of the south-facing windows should be no more than six inches from the floor or the planter bed to make sure the mass in the floor receives sufficient direct sunlight. If the windows sills are higher than that, additional mass will have to be located in the wall.

Another good location for thermal mass is the common wall (the wall separating the sunspace from the rest of the house). Options for the common wall are discussed in more detail below.

Water in various types of containers is another form of energy storage often used in sunspaces.

### Glazing

Clear, double-glazing is recommended for sunspaces. Adding the second pane makes a large improvement in energy savings. Triple-glazing or low-e coatings, on the other hand, will further improve comfort, but will have little effect on energy savings.

Windows on the east and west walls should be small (no more than 10% of the total sunspace floor area) but they are useful for cross-ventilation.

Like tilted or sloped glazing, glazed roofs can increase solar gain, but they can also present big overheating problems and become counter-productive. If either glazed roofs or tilted

glazing are used in the sunspace, special care should be taken to make sure they can be effectively shaded during the summer and, if necessary, on sunny days the rest of the year, too. The manufacturers of sunspaces and glazing are developing products with better ability to control both heat loss and heat gain (for example, roof glazing with low shading coefficients, shading treatments and devices, etc.).

You'll note that in the Performance Potential chart on page 6, sunspaces with glazed roofs or sloped glazing perform very well. This analysis assumes effective shading in the summer. If such shading is not economical or marketable in your area, you should consider using only vertical glazing, and accepting somewhat less energy performance in winter.

### **Common Wall**

There are a number of options for the sunspace common wall. In mild climates, and when the sunspace is very tightly constructed, an uninsulated frame wall is probably adequate. However, insulating the common wall to about R-10 is a good idea, especially in cold climates. An insulated common wall will help guard against heat loss during prolonged cold, cloudy periods, or if the thermal storage in the sunspace is insufficient.

If the common wall is a masonry wall, it can also be used for thermal mass, in which case it should be solid masonry approximately 4 to 8 inches thick. Another option is a frame wall with masonry veneer.

Probably the most important factor in controlling the temperature in the sunspace, and thus keeping it as comfortable and efficient as possible, is to make sure the exterior walls are tightly constructed and well-insulated.

Some solar energy may be transferred from the sunspace to the rest of the house by conduction through the common wall if it is made of thermal mass. But energy is mainly transferred by natural convection through openings in the common wall — doors, windows and/or vents.

- Doors are the most common opening in the common wall. If only doorways are used, the open area should be at least 15% of the sunspace south-glass area.

- Windows will also provide light and views. The window area in the common wall should be no larger than about 40% of the entire common wall area. If only windows are used, the operable area should be about 25% of the sunspace's total south glass area.

**Summer ventilation**

The sunspace must be vented to the outside to avoid overheating in the summer or on warm days in spring and fall. A properly vented and shaded sunspace can function much like a screened-in porch.

Operable windows and/or vent openings should be located for effective cross-ventilation, and to take advantage of the prevailing summer wind. Low inlets and high outlets can be used in a "stack effect", since warm air will rise. These ventilation areas should be at least 15% of the total sunspace glass areas.

Where natural ventilation is insufficient, or access to natural breezes is blocked, a small, thermostat-controlled fan set at about 76°F will probably be a useful addition.

<b>Examples of Heat Energy Savings Passive Solar—Sunspace 1,500 sf Single Story House</b>				
	Base Case	20%	40%	60%
<b>R-Values</b>				
Ceiling/Roof	31	30	35	40
Walls	19	18	22	25
Basement Wall	11	10	13	14
Glass	1.8	1.8	1.8	1.8
<b>Air Changes/Hour</b>	0.50	0.48	0.45	0.30
<b>Glass Area (percent of total floor area)</b>				
West	3.0%	2.0%	2.0%	2.0%
North	3.0%	4.0%	4.0%	4.0%
East	3.0%	4.0%	4.0%	4.0%
South (windows)	3.0%	3.0%	3.0%	3.0%
Sunspace	0.0%	4.6%	8.1%	13.0%
<b>Solar System Size (square feet)</b>				
South Glass	45	45	45	45
Sunspace Glass	0	69	121	195
Sunspace Thermal Mass	0	208	363	586
<b>Percent Solar Savings</b>				
	8%	26%	37%	51%
<b>Performance (Btu/yr-sf)</b>				
Conservation	51,037	52,313	46,739	40,544
Auxiliary Heat	47,085	38,575	29,090	19,564
Cooling	4,555	1,564	1,451	536
<b>Summary:</b> Insulation (for the 40 and 60% savings) and tightness have been increased. North and east-facing glazing have been increased slightly. The sunspace assumed here is semi-enclosed (surrounded on three sides by conditioned rooms of the house, as in Figure SSD1 of the worksheets), with its south glazing tilted at 50 degrees. The common wall is a thermal mass wall made of masonry. Sunspace glazing is assumed to be double.				

## 5. Thermal Storage Wall

The Thermal Storage Wall — also sometimes referred to as a Trombe wall or an indirect gain system — is a south-facing glazed wall, usually built of heavy masonry, but sometimes using water containers or phase change materials. The masonry is separated from the glazing only by a small air space. Sunlight is absorbed directly into the wall instead of into the living space. The energy is then released into the living space over a relatively long period. The time lag varies with different materials, thicknesses and other factors, but typically, energy stored in a Thermal Storage Wall during the day is released during the evening and nighttime hours.

The outside surface of a thermal storage wall should be a very dark color — an absorptance greater than 0.92 is recommended.

The summer heat gain from a Thermal Storage Wall is much less — roughly 66% less — than from a comparable area of direct gain glazing.

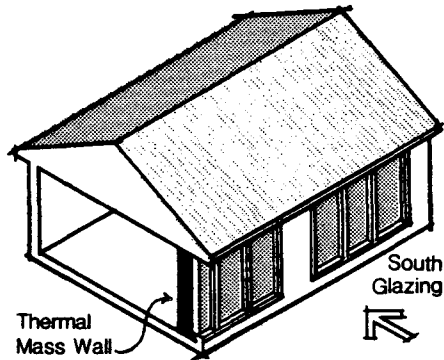

**Thermal Storage Wall**  
A thermal storage wall is an effective passive solar system, especially to provide nighttime heating.

A masonry Thermal Storage Wall should be solid, and there should be no openings or vents either to the outside or to the living space. Although vents to the living space were once commonly built into Thermal Storage Walls, experience has demonstrated that they are ineffective. Vents between the Thermal Storage Wall and the house tend to reduce the system's nighttime heating capability, and to increase the temperature fluctuation in the house. Vents to the outside are similarly ineffective, and do little to reduce summer heat gains.

### Glazing

Double glazing is recommended for Thermal Storage Walls unless a selective surface is used. In this case, single glazing performs about the same as double glazing.

The space between the glazing and the thermal mass should be one to three inches.

### Selective Surfaces

A selective surface is a special adhesive foil applied to the exterior side of the mass of Thermal Storage Walls. Selective surfaces absorb a large percentage of solar radiation but radiate very little heat back to the out-of-doors (low emittance).

To be effective, selective surfaces must be applied carefully for 100% adhesion to the mass surface.

In Rock Springs, Wyoming, a selective surface will improve Thermal Storage Wall performance by about 59%.

### Mass Material and Thickness

In general, the effectiveness of the Thermal Storage Wall will increase as the density of the material increases.

The optimum thickness of the wall depends on the density of the material chosen. The following chart indicates the recommended thickness of Thermal Storage Walls made of various materials.

Mass Wall Thickness (inches)		
Material	Density (lb/cf)	Thickness (inches)
Concrete	140	8-24
Concrete Block	130	7-18
Clay Brick	120	7-16
Lwt. Concrete Block	110	6-12
Adobe	100	6-12

**Water Walls**

Water provides about twice the heat storage per unit volume as masonry, so a smaller volume of mass can be used. In "water walls" the water is in light, rigid containers. The containers are shipped empty and easily installed. Manufacturers can provide information about durability, installation, protection against leakage and other characteristics. At least 30 pounds (3.5 gallons) of water should be provided for each square foot of glazing. This is equivalent to a water container about six inches thick, having the same area as the glazing.

Examples of Heat Energy Savings Passive Solar—Thermal Storage Wall 1,500 sf Single Story House				
	Base Case	20%	40%	60%
<b>R-Values</b>				
Ceiling/Roof	31	30	34	37
Walls	19	18	21	23
Basement Wall	11	10	12	14
Glass	1.8	1.8	1.8	1.8
<b>Air Changes/Hour</b>	0.50	0.48	0.46	0.38
<b>Glass Area (percent of total floor area)</b>				
West	3.0%	2.0%	2.0%	2.0%
North	3.0%	4.0%	4.0%	4.0%
East	3.0%	4.0%	4.0%	4.0%
South	3.0%	3.0%	3.0%	3.0%
Thermal Storage Wall	0.0%	5.9%	10.6%	17.0%
<b>Solar System Size (square feet)</b>				
South Glass	45	45	45	45
Thermal Storage Wall	0	88	159	255
<b>Percent Solar Savings</b>				
	8%	26%	40%	55%
<b>Performance (Btu/yr-sf)</b>				
Conservation	51,037	52,417	48,582	44,251
Auxiliary Heat	47,085	38,604	29,117	19,578
Cooling	4,555	1,200	826	0
<b>Summary:</b> In the case of a Thermal Storage Wall, south-facing glazing and thermal mass are incorporated together. The estimates here assume a 12-inch thick concrete Thermal Storage Wall with a selective surface and single glazing.				

## 6. Combined Systems

Although the previous sections have presented separate discussions of four different systems, it isn't necessary to choose one and only one system. In fact, passive solar features work well in combination.

For example, direct gain works very well in conjunction with a sunspace or thermal storage wall. Since thermal storage walls release energy more slowly than direct gain systems, they are useful for supplying heat in the evening and at night, whereas the direct gain system works best during the day. Although using a sunspace, thermal storage wall and direct gain system in the same house may result in excellent performance, such combinations do require a large south-facing area, and careful design to make sure the systems are well-integrated with each other and with the house's mechanical system.

## 7. Natural Cooling Guidelines

The term "natural cooling" is used here to describe techniques which help a house stay cool in summer but which require little or no energy. Natural cooling techniques work to help reduce air-conditioning, not replace it.

These techniques are useful not only in passive solar houses, but in "conventional" houses as well. The strategies outlined below — attention to the location, size and shading of glazing, using the opportunities on the site for shading and natural ventilation, and using fans — can reduce air conditioning needs and increase comfort even if the house has no passive solar heating features.

But shading is particularly important in passive solar houses, because the same features that collect sunlight so effectively in winter will go right on collecting it in summer — resulting in uncomfortably hot rooms and big air conditioning bills — unless they are shaded and the house is designed to help cool itself.

Fortunately, many of the features that help maintain comfort and reduce energy needs in winter also work well in summer. For instance, additional thermal mass performs well year-round. Masonry materials are equally effective in staying cool and storing heat. If mass surfaces can be exposed to cool night-time temperatures — a technique referred to as "night ventilation" — they will help the house stay cooler the next day. A California utility found during studies of small test buildings that on hot summer days the workmen at the facility always ate lunch in the masonry test building because it stayed much cooler than any of the others. (See Reference 9)

The additional insulation that increases winter performance will also work to improve summer performance by conserving the conditioned air inside the house. And some low-e windows and other glazing with high R-value can help shield against unwanted heat gain in summer.

The potential of some natural and low-energy cooling strategies is shown in the following table for Rock Springs.

**Worksheet IV: Cooling Performance Level** indicates the total annual cooling load, and so can give an idea of how the passive solar features increase the cooling load and how much reduction is possible when natural cooling techniques are used.

It should be noted that the Cooling Performance numbers presented in the Examples for each passive solar strategy assume that the design also includes the recommended natural cooling techniques. This is especially true of the higher percentage reductions; these assume better heating performance, but also better shading and other natural cooling strategies.

<b>Cooling Potential</b> Basecase 4,555 Btu/yr-sf		
Strategy	Energy Savings (Btu/yr-sf)	Percent Savings
No Night Ventilation <sup>1</sup>		
without ceiling fans	0	0%
with ceiling fans	1,320	29%
Night Ventilation <sup>1</sup>		
without ceiling fans	1,200	26%
with ceiling fans	2,290	50%
High Mass <sup>2</sup>		
without ceiling fans	350	8%
with ceiling fans	300	7%
<p>1 With night ventilation, the house is ventilated at night when temperature and humidity conditions are favorable.</p> <p>2 A "high mass" building is one with a thermal mass area at least equal to the house floor area.</p>		



**Glazing**

As mentioned earlier, poorly placed windows can increase air conditioning loads dramatically. It is generally best in terms of energy performance to carefully size non-solar glazing as indicated in the following table.

Orientation	Percent of Total Floor Area
East	4%
North	4%
West	2%

As mentioned earlier, west-facing windows present particularly difficult shading problems. If glazing is added above the levels indicated, the need for shading will become even more critical.

Cooling loads increase as window area increases. This relationship for Rock Springs is shown in the following table for each of the cardinal window orientations. For instance when a square foot of west area is added or subtracted, the annual cooling load increases or decreases by 13,040 Btu/yr-sf.

Orientation	Added Annual Cooling Load (Btu/yr-sf)
North	9,660
East	12,160
South	10,960
West	13,040
Skylights	15,230

These values are based on double glass with a shading coefficient of 0.88. When glazing with a different shading coefficient is used the values may be scaled proportionally.

These numbers can be reduced by shading as described in the next section.

Using special glazing or window films that block solar transmission (low shading coefficient) is an option often used in particularly hot climates, but the more effective they are at blocking sunlight, the less clear they are, as a rule,

and so they may interfere with desirable views. It is important to note, however, that some types of low-e windows block solar transmission but also allow clear views. These treatments are not recommended for south windows.

As the table shows, skylights present a high potential for overheating, and are usually difficult to shade properly. But skylights are very popular features, and they save electricity by providing good natural daylight to the house. In some parts of the country almost every new house has at least one skylight. A good working compromise can usually be achieved if skylight area is limited, and if careful attention is paid to shading, either by trees or by devices such as roller shades or blinds. The manufacturer can usually give guidance on shading options for a particular skylight design.

**Shading**

Shading strategies generally fall into three categories: landscaping, roof overhangs and exterior or interior shading devices.

**Landscaping.** The ideal site for summer shading has deciduous trees to shade the east and west windows. Even small trees such as fruit trees can help block sun hitting the first story of a house.

Trees on the south side can present a difficult choice. Even deciduous trees will shadow the solar glazing during the winter and interfere with solar gain. In fact, trees on the south side can all but eliminate passive solar performance, unless they are very close to the house and the low branches can be removed, allowing the winter sun to penetrate under the tree canopy. However, in many cases the trees around the house are bigger selling points than the energy efficiency and the builder must make a choice.

If a careful study of the shading patterns is done before construction, it should be possible to accommodate the south-facing glazing while leaving in as many trees as possible (see page 17, Site Planning for Solar Access).

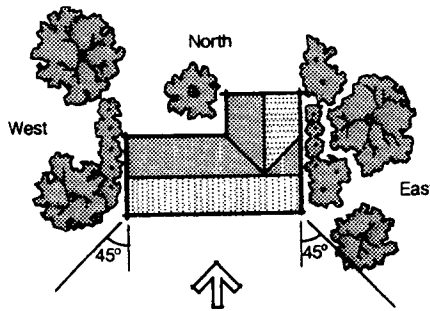

**Landscaping for Summer Shade**  
Trees and other landscaping features may be effectively used to shade east and west windows from summer solar gains.

Other landscaping ideas for summer shade:

- Trellises on east and west covered with vines.
- Shrubbery or other plantings to shade paved areas.
- Use of ground cover to prevent glare and heat absorption.
- Trees, fences, shrubbery or other plantings to "channel" summer breezes into the house.
- Deciduous trees on the east and west sides of the house, as shown above, to balance solar gains in all seasons.

**Roof Overhangs.** Fixed overhangs are an inexpensive feature, and require no operation by the home owner. They must be carefully designed, however. Otherwise, an overhang that blocks summer sun may also block sun in the spring, when solar heating is desired, and, by the same token, an overhang sized for maximum solar gain in winter will allow solar gain in the fall on hot days. The following figure may be used to determine the optimum overhang size.

In Rock Springs, an ideal overhang projection for a four foot high window would be 27 inches and the bottom of the overhang would be 15 inches above the top of the window.

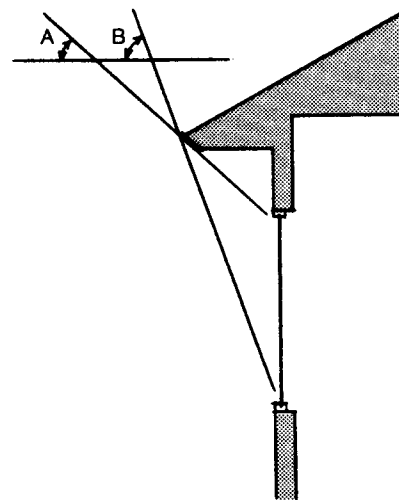

**South Overhang Sizing**  
In Rock Springs, an ideally sized south overhang should allow full exposure of the window when the sun has a noon altitude of 29 degrees (angle A) and fully shade the window when the sun has a noon altitude of 66 degrees (angle B).

A combination of carefully sized overhangs on the south windows and shading devices on the other windows will probably be an effective solution. Adjustable overhangs that can be seasonally regulated are another option.

**Shading Devices.** External shades are the most effective because they stop solar gain *before* the sun hits the building. A wide range of products are available, from canvas awnings to solar screens to roll-down blinds to shutters to vertical louvers. They are adjustable and perform very well, but their limitation is that they require the home owner's cooperation. Usually external screens that can be put up and taken down once a year like storm windows are more acceptable to home owners than those requiring more frequent operation.

Interior shades must be operated, too, and have the further disadvantage of permitting the sun to enter the house and be trapped between the window and the shading device. But highly reflective interior blinds and curtains are relatively low-cost and easy to operate.

Another shading "device" well worth considering is a porch. Especially on the east and west sides, porches add pleasant spaces to houses and are excellent for providing shade to windows. Carports located on the east or west are another option.

### Ceiling Fans

Ceiling fans will probably save more energy than any other single cooling strategy. Studies show that air movement can make people feel comfortable at higher temperatures. As a general rule, the thermostat can be set 4 degrees higher without affecting comfort if the air is moving at 100-150 feet per minute. This is enough air movement to greatly improve comfort but not enough to disturb loose papers.

Largest Room Dimension	Minimum Fan Diameter (inches)
12 feet or less	36
12 - 16 feet	48
16 - 17.5 feet	52
17.5 - 18.5 feet	56
18.5 or more feet	2 fans

A ceiling fan should have a minimum clearance of ten inches between ceiling and fan to provide adequate ventilation in a standard room with eight-foot ceilings. In rooms with higher ceilings, fans should be mounted 7.5 to 8.0 feet above the floor.

## Ventilation

When possible, the house should be positioned on the site to take advantage of prevailing winds. During the cooling season, the prevailing wind is from the southwest. Windows, stairwells, transoms and other elements should be located for maximum cross-ventilation in each room. The free vent area (unobstructed openings like open windows) should be between 6-7.5% of total floor area, half located on the leeward and half on the windward side of the building. Insect screens can reduce the effective free vent area by as much as 50%. Casement or awning windows have a 90% open area; double hung windows have only 50%.

Natural ventilation can help keep houses cool and comfortable at the beginning and end of the cooling season and thus shorten the time when air conditioning is required. But natural ventilation can seldom do the entire cooling job, especially for less than ideal sites with little natural air movement.

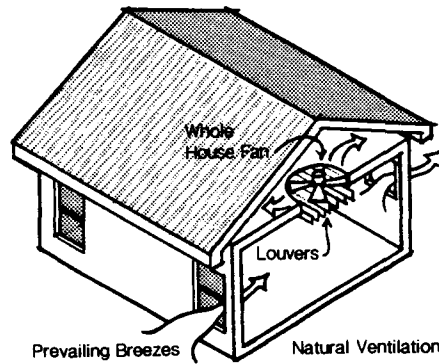

**Ventilation for Summer Cooling**  
*Natural ventilation is often impaired by vegetation and topography. Ventilation fans do not depend on surroundings to be effective.*

In cooling climates, a whole-house fan is a good idea for assisting ventilation, especially in houses with sites or designs that make natural ventilation difficult. On the other hand, when the temperature is higher than about 76°F, a whole-house fan will not be very effective.

Research indicates that a whole-house fan should pull approximately 10 ACH. A rule of thumb: for rooms with eight foot ceilings, total floor area multiplied by 1.34 will equal the necessary CFM of the fan. For 10 foot ceilings, multiply floor area by 1.67.

The best possible performance of a whole-house fan results when a timer, a thermostat and a "humidistat" are used, so that the fan would only operate when there is less than 60% relative humidity and a temperature of less than 76°F.

Natural ventilation and whole-house fans are effective at removing heat, but not at moving air. Ceiling fans, on the other hand, can often create enough of a breeze to maintain comfort at higher temperatures, and still use less power than required by air conditioning. By using natural cooling strategies and low-energy fans, the days when air-conditioning is needed can be reduced substantially.



Passive Solar  
Design Strategies

# EXAMPLE

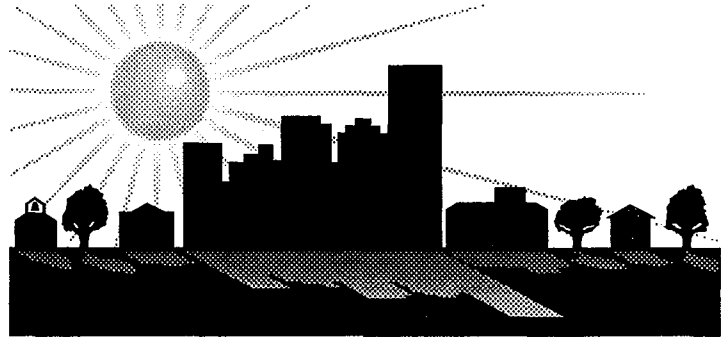

Passive Solar Industries Council  
National Renewable Energy Laboratory  
Charles Eley Associates  
*With Support From:*  
U.S. Department of Energy

**Rock Springs  
Wyoming**

**The Worked  
Example**

## The Worked Example

### Description of Example Building

A 1,504 square foot passive solar, single-family home is used to illustrate how to fill in the worksheets. See sketches for the building layout. A variety of design features have been incorporated into the house to help illustrate how to handle different situations in the worksheets.

The building selected has good insulation as described on Worksheet I.

The east portion of the house is slab on grade. The great room and master bedroom are constructed over a basement.

The house has a semi-enclosed sunspace with glazing sloped at 50 degrees. The sunspace floor has a four-inch thick slab-on-grade with quarry tile set in a mortar bed. The sunspace is separated from the conditioned portion of the house by sliding glass doors and a masonry fireplace wall. Sunspace ventilation is provided to the outside by awning windows located at the top and bottom of the south wall.

South facing windows provide direct gain solar heating to the dining area, kitchen and master bedroom. The south glazing in the kitchen and dining area provides heat to an exposed slab-on-grade finished with ceramic tile to provide direct gain heat storage.

The house faces 10 degrees to the east of true south.

The house is equipped with a ceiling fan to help reduce the air-conditioning load. North windows have an overhang with a projection factor of 0.30. East and west windows are small and have no effective overhang because of the gable roof. South windows, including the sunspace windows, have an overhang with a projection factor of 0.20.

Take-offs from the house are given in the worksheets. Refer to the circled values in the worksheet tables to locate where the various values which show up in the worksheets come from.

Performance is found to be satisfactory on all four worksheets.

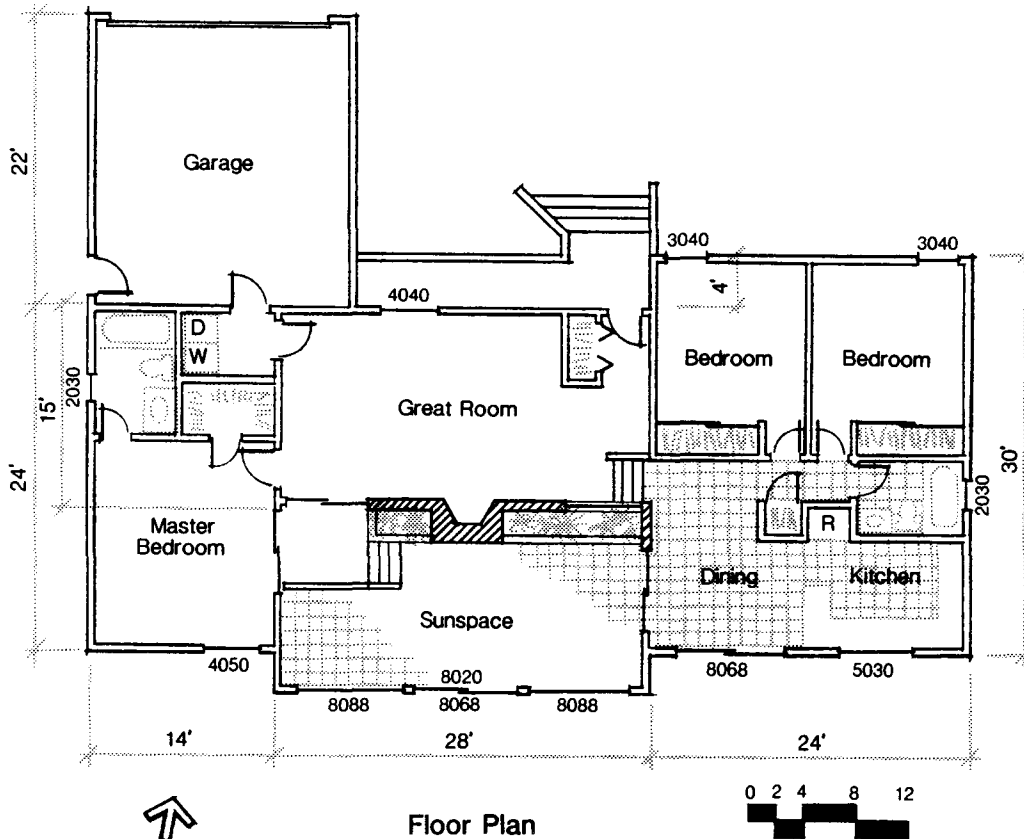

Floor Plan



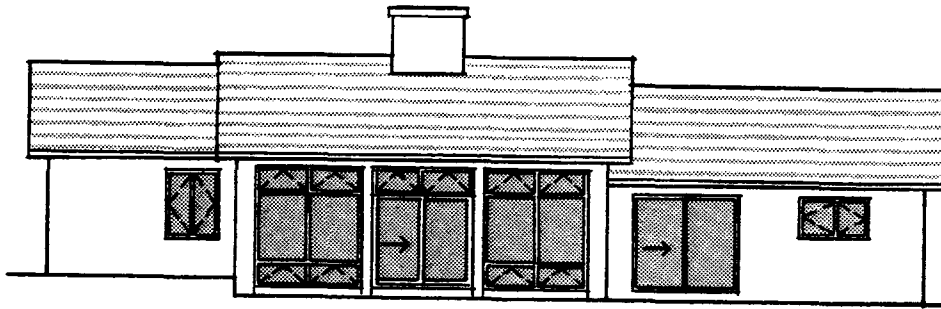

South Elevation

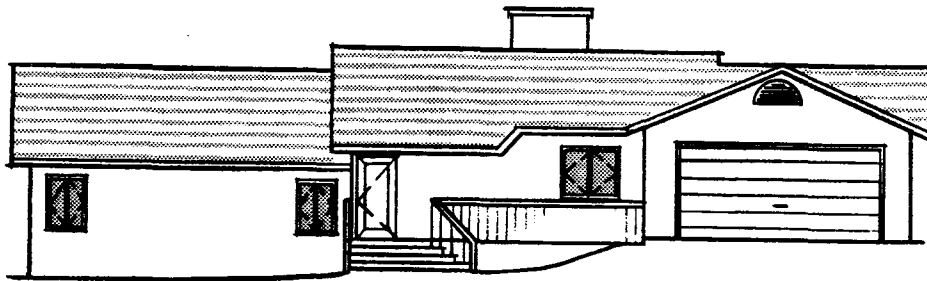

North Elevation

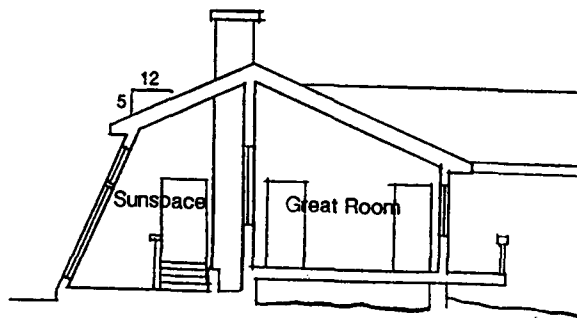

Section

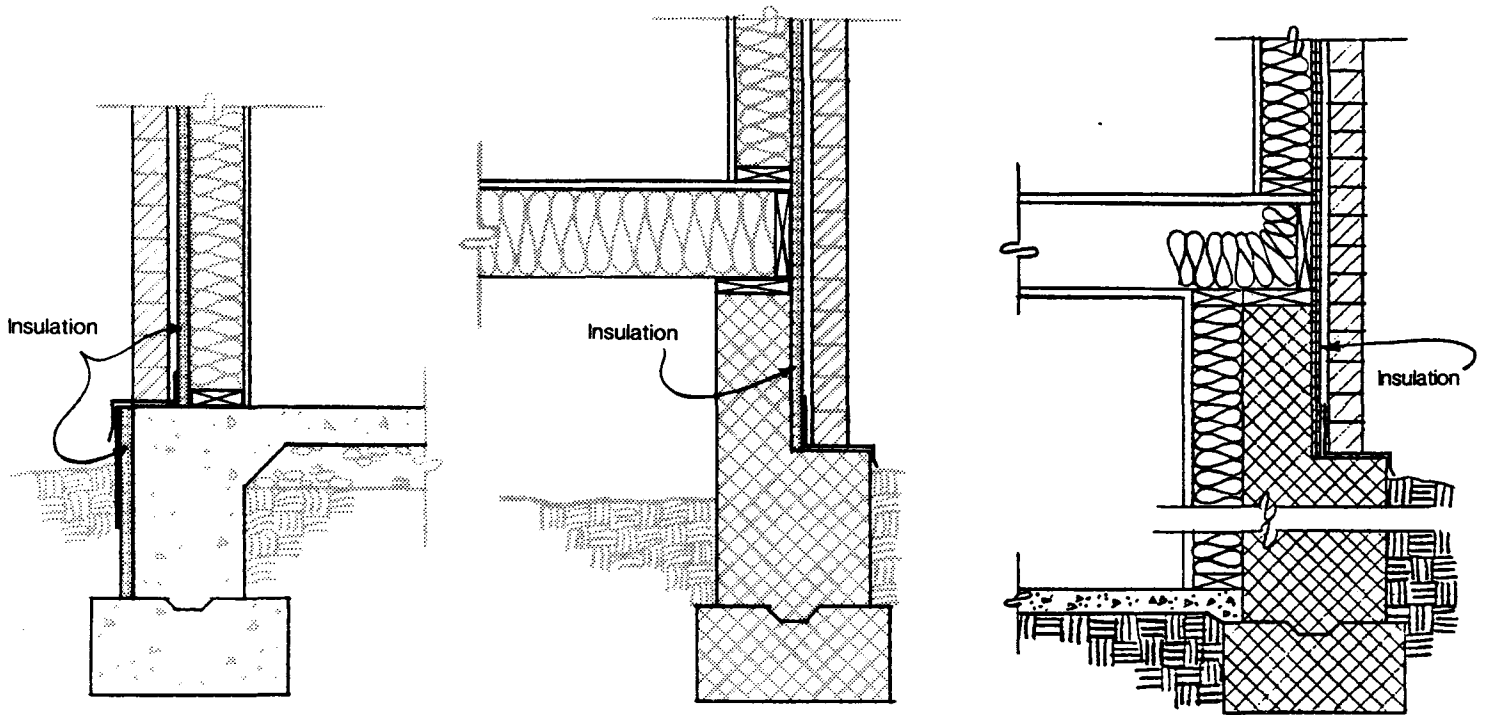

Passive Solar  
Design Strategies

# WORKSHEETS

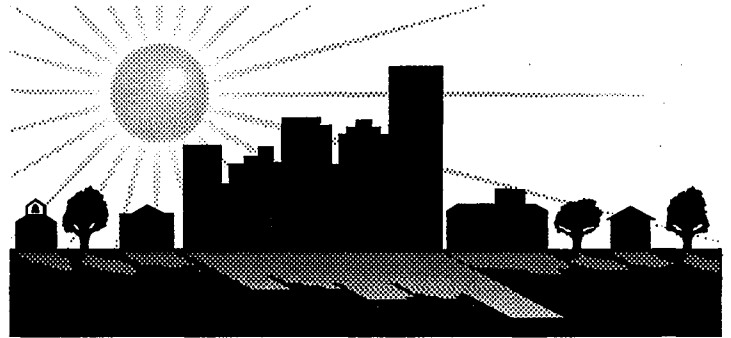

Passive Solar Industries Council  
National Renewable Energy Laboratory  
Charles Eley Associates  
*With Support From:*  
U.S. Department of Energy

NOTE: These worksheets are completed for the example house described on the previous pages. Also the reference tables are marked up showing how the numbers are selected.

**Rock Springs  
Wyoming**

**Worksheets**

## General Project Information

Project Name	<u>PASSIVE SOLAR EXAMPLE</u>	Floor Area	<u>1504 sq.</u>
Location	<u>ROCK SPRINGS, WYOMING</u>	Date	<u>05/04/93</u>
Designer	_____		_____

## Worksheet I: Conservation Performance Level

### A. Envelope Heat Loss

Construction Description	Area		R-value [Table A]	=	Heat Loss		
Ceilings/roofs	<u>R-60 W ATTIC</u>	<u>1084</u>	<u>+</u>	<u>57.9</u>	<u>=</u>	<u>19</u>	
	<u>R-38 IN CATHEDRAL CEILING</u>	<u>420</u>	<u>+</u>	<u>31.4</u>	<u>=</u>	<u>13</u>	
Walls	<u>R-19 + R-10 SHEATHING</u>	<u>992</u>	<u>+</u>	<u>27.7</u>	<u>=</u>	<u>36</u>	
	<u>R-19 AT GARAGE</u>	<u>140</u>	<u>+</u>	<u>17.7</u>	<u>=</u>	<u>8</u>	
Insulated Floors			<u>+</u>		<u>=</u>		
			<u>+</u>		<u>=</u>		
Non-solar Glazing	<u>DOUBLE GLAZED WINDOWS; LAJ-e</u>	<u>52</u>	<u>+</u>	<u>3.1</u>	<u>=</u>	<u>17</u>	
			<u>+</u>		<u>=</u>		
Doors	<u>METAL DOOR W/FOAM CORE</u>	<u>40</u>	<u>+</u>	<u>5.9</u>	<u>=</u>	<u>7</u>	
			<u>+</u>		<u>=</u>		
						<u>100</u>	Btu/°F-h
						Total	

### B. Foundation Perimeter Heat Loss

Description	Perimeter		Heat Loss Factor [Table B]	=	Heat Loss		
Slabs-on-Grade	<u>R-7</u>	<u>110</u>	<u>×</u>	<u>0.30</u>	<u>=</u>	<u>33</u>	
Heated Basements	<u>R-11</u>	<u>84</u>	<u>×</u>	<u>0.60</u>	<u>=</u>	<u>50</u>	
Unheated Basements			<u>×</u>		<u>=</u>		
Perimeter Insulated Crawlspace			<u>×</u>		<u>=</u>		
						<u>83</u>	Btu/°F-h
						Total	

### C. Infiltration Heat Loss

$$\frac{12482}{\text{Building Volume}} \times \frac{0.50}{\text{Air Changes per Hour}} \times .018 = 112 \text{ Btu/°F-h}$$

### D. Total Heat Loss per Square Foot

$$24 \times \frac{295}{\text{Total Heat Loss (A+B+C)}} + \frac{1504}{\text{Floor Area}} = 4.707 \text{ Btu/DD-sf}$$

### E. Conservation Performance Level

$$\frac{4.707}{\text{Total Heat Loss per Square Foot}} \times \frac{7876}{\text{Heating Degree Days [Table C]}} \times \frac{0.95}{\text{Heating Degree Day Multiplier [Table C]}} = 35219 \text{ Btu/yr-sf}$$

### F. Comparison Conservation Performance (From Previous Calculation or from Table D)

$$\frac{51037}{\text{Btu/yr-sf}}$$

Compare Line E to Line F



**Worksheet III: Thermal Mass/Comfort**

**A. Heat Capacity of Sheetrock and Interior Furnishings**

	Floor Area		Unit Heat Capacity	=	Total Heat Capacity	
Rooms with Direct Gain	464	×	4.7	=	2181	
Spaces Connected to Direct Gain Spaces	949	×	4.5	=	4271	
					<u>6452</u>	Btu/°F
					Total	

**B. Heat Capacity of Mass Surfaces Enclosing Direct Gain Spaces**

Mass Description (include thickness)	Area		Unit Heat Capacity [Table H]	=	Total Heat Capacity	
Trombe Walls		×	8.8	=		
Water Walls		×	10.4	=		
Exposed Slab in Sun	103	×	13.4	=	1380	
Exposed Slab Not in Sun	137	×	1.8	=	247	
		×		=		
		×		=		
		×		=		
					<u>1627</u>	Btu/°F
					Total	

**C. Heat Capacity of Mass Surfaces Enclosing Spaces Connected to Direct Gain Spaces**

Mass Description (include thickness)	Area		Unit Heat Capacity [Table H]	=	Total Heat Capacity	
Trombe Walls		×	3.8	=		
Water Walls		×	4.2	=		
FACE BRICK	111	×	3.7	=	411	
		×		=		
		×		=		
					<u>411</u>	Btu/°F
					Total	

**D. Total Heat Capacity**

$$\frac{8490}{(A+B+C)} \text{ Btu/°F}$$

**E. Total Heat Capacity per Square Foot**

$$\frac{8490}{1504} = 5.6 \text{ Btu/°F-sf}$$

**F. Clear Winter Day Temperature Swing**

	Total Projected Area [Worksheet II]		Comfort Factor [Table I]	=		
Direct Gain	69	×	820	=	56580	
Sunspaces or	125	×	270	=	33750	
Vented Trombe Walls					<u>90330</u>	
					Total	
				÷	$\frac{8490}{\text{Total Heat Capacity}}$	10.6 °F

**G. Recommended Maximum Temperature Swing**

$$\frac{13}{\text{Total Heat Capacity}} \text{ °F}$$

Compare Line F to Line G

### Worksheet IV: Summer Cooling Performance Level

#### A. Opaque Surfaces

Description	Heat Loss [Worksheet I]		Radiant Barrier Factor [Table J]		Absorptance [Table K]		Heat Gain Factor [Table L]	=	Load	
Ceilings/roofs	19	×	1.00	×	0.47	×	5.9	=	53	
	13	×	1.00	×	0.47	×	5.9	=	36	
		×		×		×		=		
Walls	36	×	na		0.70	×	4.2	=	106	
		×	na			×		=		
Doors	3	×	na		0.30	×	4.2	=	4	
									199	
									Total	kBtu/yr

#### B. Non-solar Glazing

Description	Rough Frame Area		Net Area Factor		Shade Factor [Table M]		Heat Gain Factor [Table L]	=	Load	
North Glass	40	×	0.80	×	0.67	×	9.7	=	208	
East Glass	6	×	0.80	×	0.80	×	12.2	=	47	
West Glass	6	×	0.80	×	0.80	×	13.0	=	50	
Skylights		×	0.80	×		×		=		
									305	
									Total	kBtu/yr

#### C. Solar Glazing

Solar System Description	Rough Frame Area		Net Area Factor		Shade Factor [Table M]		Heat Gain Factor [Table L]	=	Load	
Direct Gain	88	×	0.80	×	0.37	×	11.0	=	287	
Storage Walls		×	0.80	×		×		=		
Sunspace	208	×	0.80	×	1.00	×	10.9	=	1814	
		×	0.80	×		×		=		
									2101	
									Total	kBtu/yr

**D. Internal Gain**  $\frac{80}{\text{Constant Component [Table N]}} + \left( \frac{40}{\text{Variable Component [Table N]}} \times \frac{3}{\text{Number of Bedrooms}} \right) = 200$  kBtu/yr

**E. Cooling Load per Square Foot**  $1,000 \times \frac{2805}{(A+B+C+D)} \div \frac{1504}{\text{Floor Area}} = 1865$  Btu/yr-sf

**F. Adjustment for Thermal Mass and Ventilation**  $\frac{-1305}{\text{[Table O]}}$  Btu/yr-sf  
*No NIGHT VENTILATION, YES CEILING FAN.*

**G. Cooling Performance Level**  $\frac{3170}{(E-F)}$  Btu/yr-sf

**H. Comparison Cooling Performance** (From Previous Calculation or from Table P)  $\frac{4555}{\text{[Table P]}}$  Btu/yr-sf

Compare Line G to Line H



**Table A—Equivalent Thermal Performance of Assemblies R-values (hr-F-sf/Btu)**

A1—Ceilings/Roofs				
Attic Construction	Insulation R-value			
	R-30	R-38	R-49	R-60
	27.9	35.9	46.9	57.9
Framed Construction				
	Insulation R-value			
	R-19	R-22	R-30	R-38
2x6 at 16°oc	14.7	15.8	16.3	—
2x6 at 24°oc	15.3	16.5	17.1	—
2x8 at 16°oc	17.0	18.9	20.6	21.1
2x8 at 24°oc	17.6	19.6	21.6	22.2
2x10 at 16°oc	18.1	20.1	24.5	25.7
2x10 at 24°oc	18.4	20.7	25.5	26.8
2x12 at 16°oc	18.8	21.0	25.5	30.1
2x12 at 24°oc	19.0	21.4	27.3	31.4

**A2—Framed Walls**

Single Wall Framing	Insulation R-value			
	R-11	R-13	R-19	R-25
2x4 at 16°oc	12.0	13.6	—	—
2x4 at 24°oc	12.7	13.9	—	—
2x6 at 16°oc	14.1	15.4	17.7	19.2
2x6 at 24°oc	14.3	15.6	18.2	19.8
Double Wall Framing				
	Total Thickness (inches)			
	8	10	12	14
	25.0	31.3	37.5	43.8

The R-value of insulating sheathing should be added to the values in this table.

**A3—Insulated Floors**

Framing	Insulation R-value			
	R-11	R-19	R-30	R-38
2x6s at 16°oc	18.2	23.8	29.9	—
2x6s at 24°oc	18.4	24.5	31.5	—
2x8s at 16°oc	18.8	24.9	31.7	36.0
2x8s at 24°oc	18.9	25.4	33.1	37.9
2x10 at 16°oc	19.3	25.8	33.4	38.1
2x10 at 24°oc	19.3	26.1	34.4	39.8
2x12 at 16°oc	19.7	26.5	34.7	39.8
2x12 at 24°oc	19.6	26.7	35.5	41.2

These R-values include the buffering effect of a ventilated crawlspace or unconditioned basement.

**A4—Windows**

	Standard Frame		Metal Frame w/ Thermal Break
	Wood Frame	Metal Frame	
Double 1/4" space	1.8	1.4	1.5
Double 1/2" space	2.4	1.6	1.8
Double Low-e	3.1	2.2	3.0
Triple 1/4" space	2.7	1.8	2.1
Triple 1/2" space	3.3	2.2	2.7

These R-values are for the entire rough frame window opening. When storm sash is added, an additional 1.1 may be added. One half the R-value of moveable insulation may also be added, when appropriate.

**Table A—continued ..**

A5—Doors	
Solid wood with Weatherstripping	2.2
Metal with rigid foam core	5.9

**Table B—Perimeter Heat Loss Factors for Slabs-on-Grade and Basements (Btu/h-F-ft)**

Perimeter Insulation	Slabs-on-Grade	Heated Basements	Unheated Basements	Insulated Crawlspaces
None	0.8	1.3	1.1	1.1
R-5	0.4	0.8	0.7	0.6
R-7	0.3	0.7	0.6	0.5
R-11	0.3	0.6	0.5	0.4
R-19	0.2	0.4	0.5	0.3
R-30	0.1	0.3	0.4	0.2

**Table C—Heating Degree Days (F-day)**

C1—Heating Degree Days (Base 65°F)	
Rock Springs	7,876

**C2—Heating Degree Day Multiplier**

Heat Loss per Square Foot	Passive Solar Glazing Area per Square Foot				
	.00	.05	.10	.15	.20
12.00	1.07	1.08	1.08	1.08	1.09
11.50	1.07	1.07	1.08	1.08	1.08
11.00	1.06	1.07	1.07	1.07	1.08
10.50	1.06	1.06	1.07	1.07	1.07
10.00	1.05	1.06	1.06	1.06	1.07
9.50	1.04	1.05	1.05	1.06	1.06
9.00	1.04	1.04	1.05	1.05	1.06
8.50	1.03	1.03	1.04	1.04	1.05
8.00	1.02	1.02	1.03	1.04	1.04
7.50	1.01	1.01	1.02	1.03	1.03
7.00	1.00	1.00	1.01	1.02	1.03
6.50	0.98	0.99	1.00	1.01	1.02
6.00	0.96	0.98	0.99	1.00	1.00
5.50	0.94	0.96	0.97	0.98	0.99
5.00	0.92	0.94	0.95	0.97	0.98
4.50	0.89	0.91	0.93	0.95	0.96
4.00	0.85	0.88	0.90	0.92	0.94
3.50	0.81	0.84	0.87	0.90	0.92
3.00	0.76	0.80	0.83	0.86	0.89
2.50	0.68	0.74	0.78	0.82	0.85
2.00	0.58	0.66	0.72	0.77	0.80

**Table D—Base Case Conservation Performance (Btu/yr-sf)**

Base Case	51,037
-----------	--------

**Table E—Projected Area Adjustment Factors**

Degrees off True South	Solar System Type		
	DG, TW, WW, SSC	SSA, SSD	SSB, SSE
0	1.00	0.77	0.75
5	1.00	0.76	0.75
10	0.98	0.75	0.74
15	0.97	0.74	0.73
20	0.94	0.72	0.70
25	0.91	0.69	0.68
30	0.87	0.66	0.65

**Table F—Solar System Saving Fractions**

Load Collector Ratio	F1—Direct Gain		
	DGC1 Double Glazing	DGC2 Low-e Glazing	DGC3 R-9 Night Insulation
400	0.04	0.05	0.06
300	0.06	0.06	0.08
200	0.08	0.10	0.12
150	0.11	0.13	0.15
100	0.16	0.18	0.22
80	0.19	0.22	0.27
60	0.24	0.28	0.34
50	0.27	0.32	0.40
45	0.29	0.35	0.43
40	0.32	0.38	0.47
35	0.35	0.43	0.52
30	0.39	0.48	0.58
25	0.44	0.54	0.66
20	0.50	0.61	0.74
15	0.57	0.70	0.83

**F2—Trombe Walls**

Load Collector Ratio	Trombe Wall Types			
	TWF3 Unvented Non-selective	TWA3 Vented Non-selective	TWJ2 Unvented Selective	TWJ4 Unvented Night Insulation
400	0.03	0.05	0.03	0.00
300	0.04	0.07	0.06	0.03
200	0.07	0.10	0.12	0.07
150	0.10	0.13	0.16	0.12
100	0.14	0.18	0.25	0.19
80	0.18	0.21	0.31	0.24
60	0.22	0.26	0.39	0.32
50	0.26	0.30	0.44	0.37
45	0.28	0.32	0.48	0.40
40	0.31	0.35	0.52	0.44
35	0.34	0.38	0.56	0.48
30	0.38	0.42	0.61	0.54
25	0.43	0.47	0.68	0.60
20	0.49	0.53	0.75	0.67
15	0.58	0.62	0.83	0.77

F3—Water Walls

Load Collector Ratio	WWA3 No Night Insulation	WWB4 Night Insulation	WWC2 Selective Surface
400	0.05	0.01	0.02
300	0.06	0.04	0.05
200	0.10	0.10	0.10
150	0.13	0.15	0.15
100	0.19	0.24	0.24
80	0.23	0.30	0.30
60	0.29	0.39	0.38
50	0.33	0.45	0.44
45	0.36	0.49	0.47
40	0.39	0.53	0.51
35	0.42	0.57	0.56
30	0.47	0.63	0.61
25	0.52	0.69	0.68
20	0.59	0.77	0.75
15	0.68	0.85	0.84

F4—Sunspaces

Load Collector Ratio	Sunspace Type				
	SSA1	SSB1	SSC1	SSD1	SSE1
400	0.10	0.08	0.04	0.10	0.08
300	0.12	0.10	0.06	0.13	0.10
200	0.16	0.13	0.09	0.17	0.14
150	0.19	0.15	0.12	0.21	0.17
100	0.24	0.20	0.17	0.28	0.23
80	0.27	0.23	0.20	0.32	0.27
60	0.32	0.27	0.25	0.38	0.32
50	0.36	0.31	0.29	0.42	0.36
45	0.38	0.33	0.31	0.45	0.39
40	0.41	0.35	0.34	0.48	0.41
35	0.44	0.38	0.37	0.51	0.45
30	0.48	0.41	0.41	0.56	0.49
25	0.52	0.46	0.46	0.61	0.53
20	0.58	0.51	0.52	0.67	0.59
15	0.65	0.59	0.61	0.74	0.67

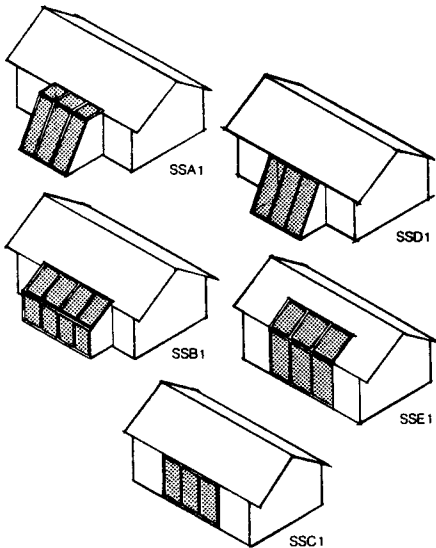

Table G—Base Case Auxiliary Heat Performance (Btu/yr-sf)

Base Case 47,085

Table H—Unit Heat Capacities (Btu/F-sf)

H1—Mass Surfaces Enclosing Direct Gain Spaces

Material	Thickness (inches)						
	1	2	3	4	6	8	12
Poured Conc.	1.8	4.3	6.7	8.8	11.3	11.5	10.3
Conc. Masonry	1.8	4.2	6.5	8.4	10.2	10.0	9.0
Face Brick	2.0	4.7	7.1	9.0	10.4	9.9	9.0
Flag Stone	2.1	4.8	7.1	8.5	8.6	8.0	7.6
Builder Brick	1.5	3.7	5.4	6.5	6.6	6.0	5.8
Adobe	1.3	3.2	4.8	5.5	5.4	4.9	4.8
Hardwood	0.4	1.4	1.8	1.7	1.5	1.5	1.5
Water	5.2	10.4	15.6	20.8	31.2	41.6	62.4

H2—Rooms with no Direct Solar Gain

Material	Thickness (inches)						
	1	2	3	4	6	8	12
Poured Conc.	1.7	3.0	3.6	3.8	3.7	3.6	3.4
Conc. Masonry	1.6	2.9	3.5	3.6	3.6	3.4	3.2
Face Brick	1.8	3.1	3.6	3.7	3.5	3.4	3.2
Flag Stone	1.9	3.1	3.4	3.4	3.2	3.1	3.0
Builder Brick	1.4	2.6	3.0	3.1	2.9	2.7	2.7
Adobe	1.2	2.4	2.8	2.8	2.6	2.4	2.4
Hardwood	0.5	1.1	1.3	1.2	1.1	1.0	1.1

Table I—Comfort Factors (Btu/sf)

Direct Gain	820
Sunspaces and Vented Trombe Walls	270

Table J—Radiant Barrier Factors

Radiant Barrier	0.75
No Radiant Barrier	1.00

Table K—Solar Absorptances

Color	Absorptance
Gloss White	0.25
Semi-gloss White	0.30
Light Green	0.47
Kelly Green	0.51
Medium Blue	0.51
Medium Yellow	0.57
Medium Orange	0.58
Medium Green	0.59
Light Buff Brick	0.60
Bare Concrete	0.65
Red Brick	0.70
Medium Red	0.80
Medium Brown	0.84
Dark Blue-Grey	0.88
Dark Brown	0.88

Table L—Heat Gain Factors

Ceiling/roofs	5.9
Walls and Doors	4.2
North Glass	9.7
East Glass	12.2
West Glass	13.0
Skylights	15.2
Direct Gain Glazing	11.0
Trombe Walls and Water Walls	3.7
Sunspaces	
SSA1	10.9
SSB1	10.9
SSC1	3.7
SSD1	10.9
SSE1	10.9

Table M—Shading Factors

Projection Factor	Direction			
	South	East	North	West
0.00	1.00	1.00	1.00	1.00
0.20	0.46	0.89	0.89	0.89
0.40	-0.90	0.49	0.79	0.44
0.60	-	0.07	0.66	-0.04
0.80	-	-0.39	0.53	-0.65
1.00	-	-0.88	0.40	-1.35
1.20	-	-1.50	0.27	-1.67

MULTIPLY BY 0.80 FOR LAZE

Table N—Internal Gain Factors

Constant Component	080 kBtu/yr
Variable Component	040 kBtu/yr-BR

Table O—Thermal Mass and Ventilation Adjustment (Btu/yr-sf)

Total Heat Capacity per SF	Night Vent w/ Ceil. Fan		No Night Vent w/ Ceil. Fan	
	Night	No Night	Night	No Night
0.0	-1,000	-2,060	-1,960	-3,260
1.0	-800	-1,880	-1,760	-3,080
2.0	-640	-1,730	-1,610	-2,930
3.0	-530	-1,620	-1,490	-2,820
4.0	-440	-1,530	-1,410	-2,730
5.0	-380	-1,460	-1,340	-2,650
6.0	-330	-1,400	-1,290	-2,600
7.0	-290	-1,350	-1,260	-2,550
8.0	-260	-1,320	-1,230	-2,520
9.0	-240	-1,290	-1,210	-2,490
10.0	-230	-1,270	-1,190	-2,470

Total heat capacity per square foot is calculated on Worksheet III, Step E.

Table P—Base Case Cooling Performance (Btu/sf-yr)

Base Case 4,555



## Glossary

**Auxiliary Heating System:** a term for the system (gas, electric, oil, etc.) which provides the non-solar portion of the house's heating energy needs, referred to as the "auxiliary heat."

**British Thermal Unit (Btu):** a unit used to measure heat. One Btu is about equal to the heat released from burning one kitchen match.

**Conservation:** in addition to energy conservation in the general sense, the term is used to refer to the non-solar, energy-saving measures in a house which are primarily involved with improving the building envelope to guard against heat loss -- the insulation, the air infiltration reduction measures, and so forth.

**Direct Gain:** a passive solar system in which the sunlight falls directly into the space where it is stored and used.

**Glazing:** often used interchangeably with window or glass, the term actually refers to specifically just to the clear material which admits sunlight, and so can also be plastic. Double and triple glazing refer to two or three panes.

**Indirect Gain:** a passive solar system in which the sunlight falls onto thermal mass which is positioned between the glazing and the space to be heated, i.e. a Thermal Storage Wall or Trombe Wall.

**Low-Emissivity:** the term refers to a surface's ability to absorb and re-radiate heat. A material with a low emissivity absorbs and re-radiates relatively small amounts of heat. Low-emissivity or "low-e" glass sandwiches a thin layer of metallic film or coating between two panes of glass. The low-e glass blocks radiant heat, so it will tend to keep heat energy inside the house during the winter, and keep heat energy outside the house during the summer.

**Passive Solar:** design and construction techniques which help a building make use of solar energy by non-mechanical means, as opposed to active solar techniques which use equipment such as roof-top collectors.

**Phase-Change Materials:** materials such as salts or waxes which store and release energy by changing "phase"; most store energy when they turn liquid at a certain temperature and release energy when they turn solid at a certain temperature, but some remain solid but undergo chemical changes which store and release energy. Phase change materials can be used as thermal mass but few products are commercially available at this time..

**Purchased Energy:** although the terms are often used interchangeably, a house's "purchased energy" is generally greater than its "auxiliary heat" because heating systems are seldom 100% efficient, and more energy is purchased than is actually delivered to the house.

**R-Value:** a unit that measures the resistance to heat flow through a given material. The higher the R-value, the better insulating capability the material has. The R-value is the reciprocal of the U-value. (see below)

**Radiant Barrier:** reflective material used in hot climates to block radiant heat, particularly in a house's roof.

**Shading Coefficient:** a measure of how much solar heat will be transmitted by a glazing material, as compared to a single pane of clear uncoated glass, which has a shading coefficient (SC) of 1. For example, clear double-pane glass might have an SC in the range of .88. Reflective glass might have SC's of .03-.06. In general, lower shading coefficients are desirable when heat gain is a problem.

**Sunspace:** passive solar system sometimes also referred to as an isolated gain system, where sunlight is collected and stored in a space separate from the living space, and must be transferred there either by natural convection or by fans.

**Suntempering:** a modest form of a direct gain passive solar system; suntempered houses increase south-facing glass to about 7 percent of a total floor area, but add no thermal mass beyond the "free" mass already in a typical house -- gypsum board, framing, conventional furnishings and floor coverings.

**Temperature Swing:** a measure of the number of degrees the temperature in a space will vary during the course of a sunny winter day without the furnace operating; an indicator of the amount of thermal mass in the passive solar system.

**Thermal Mass:** material that stores energy, although mass will also retain coolness. The thermal storage capacity of a material is a measure of the material's ability to absorb and store heat. Thermal mass in passive solar buildings is usually dense material such as brick or concrete masonry, but can also be tile, water, phase change materials, etc.

**Thermal Storage Wall:** a passive solar system also sometimes called Trombe Wall or indirect gain system; a south-facing glazed wall, usually made of masonry but can also be made of containers of water.

**Trombe Wall:** a thermal storage wall, referred to by the name of its inventor, Dr. Felix Trombe.

**U-Value:** a unit representing the heat loss per square foot of surface area per degree °F of temperature difference (see R-value above).

## References

### General

1. *A Sunbuilder's Primer*, Solar Energy Research Institute.
2. *Passive: It's a Natural*, Solar Energy Research Institute.
3. *The Passive Solar Construction Handbook*, Steven Winter Associates/Northeast Solar Energy Center/National Concrete Masonry Association/Portland Cement Association/Brick Institute of America. Available for \$29.95 plus \$3.00 handling, from Steven Winter Associates, Attn: Publications, 6100 Empire State Building, New York, N.Y. 10001
4. *Suntempering in the Northeast*, Steven Winter Associates. Available from them at the address above for \$9.50.
5. *Passive Solar Design Handbook, Volume I, II, III*. Available from National Technical Information Service, U.S. Dept. of Commerce, 5285 Port Royal Road, Springfield, Va, 22161, \$32.00 each for I and II, \$12.00 for III.
6. Balcomb, J.D., et al. *Passive Solar Heating Analysis*. This volume supercedes and expands Volume III of the Passive Solar Design Handbook (Ref. 5). Available from ASHRAE, Publications, 1791 Tullie Circle NE, Atlanta, Ga, 30329, \$30.00 for ASHRAE members, \$60.00 for non-members.
7. *Living With the Sun* (for consumers) and *Building With the Sun* (for builders), PPG Industries.
8. *The Passive Solar Information Guide*, PSIC.
9. *Passive Solar Trends*. Technical briefs from PSIC.
  - a. Infiltration in Passive Solar Construction
  - b. The State of the Art in Passive Solar Construction
  - c. Passive Solar in Factory-Built Housing
  - d. Radiant Barriers: Top Performers in Hot Climates
  - e. Glazings: The Design Considerations Aren't As Clear As Glass
  - f. Ideas for Passive Solar Remodeling
  - g. Passive Homes in the Marketplace (Class C Studies)
  - h. Daylighting in Commercial Buildings
  - i. Human Comfort and Passive Solar Design
  - j. Passive Design for Commercial Buildings
  - k. Passive Solar: Principles and Products
  - l. Increasing Design Flexibility
  - m. Utilities and Passive: Predicting the Pay-off

### Insulation

10. *NAHB Insulation Manual*, National Association of Home Builders, National Research Center. Available from NAHB Bookstore, 15th and M Streets N.W., Washington, D.C. 20005. (202) 822-0200.

11. Lischkoff, James K. *The Airtight House: Using the Airtight Drywall Approach*, Iowa State University Research Foundation. Available for \$14.95; Attn: Sarah Terrones, EES Building, Iowa State University, Ames, IA. 50011

12. Spears, John. *Radon Reduction in New Construction, Interim Guide*, National Association of Home Builders, Environmental Protection Agency OPA 87-009, August 1987. Available from the EPA or the NAHB Bookstore, 15th and M Streets N.W., Washington, D.C. 20005. (202) 822-0200.

### Appliances

13. *Saving Energy and Money with Home Appliances*, Environmental Science Department, Massachusetts Audubon Society/American Council for an Energy Efficient Economy. Available for \$2.00 apiece from ACEE, 1001 Connecticut Ave. N.W., Suite 535, Washington D.C. 20036

14. *The Most Energy Efficient Appliances*, 1988 Edition, ACEEE, \$2.00 apiece at address above.

**Site Planning**

15. *Builder's Guide to Passive Solar Home Design and Land Development*, National Fenestration Council. Available for \$12.00 from NFC, 3310 Harrison, White Lakes Professional Building, Topeka, KS. 66611

16. *Site Planning for Solar Access*, U.S. Department of Housing and Urban Development/American Planning Association. Available for \$6.50 from Superintendent of Documents, U.S. Government Printing Office, Washington D.C. 20402

**Sunspaces**

17. Jones, Robert W. and Robert D. McFarland. *The Sunspace Primer: A Guide for Passive Solar Heating*, available for \$32.50 from Van Nostrand Reinhold, 115 5th Avenue, New York, N.Y. 10003

18. *Greenhouses for Living*, from Steven Winter Associates, Attn: Publications, 6100 Empire State Building, New York, N.Y. 10001, \$6.95.

19. *Concept IV*, from Andersen Corporation, Bayport, MN. 55003, \$6.95.

20. *Passive Solar Greenhouse Design and Construction*, Ohio Department of Energy/John Spears, 8821 Silver Spring, Md., 20910.

**More Information**

**Conservation and Renewable Energy Inquiries and Referral Service (CAREIRS)** 1-800-523-2929, Renewable Energy Information, Box 8900, Silver Spring, Md. 20907

**National Association of Home Builders**  
Attention: Technical Services  
15th & M Streets N.W.  
Washington, D.C. 20005

**National Concrete Masonry Association**

Attention: Energy Engineer  
2302 Horse Pen Road  
Herndon, Va. 22070

**Brick Institute of America**

Attention: Energy Engineer  
11490 Commerce Park Drive  
Suite 300  
Reston, Va. 22091

**Solar Energy Research Institute**

Attention: Solar Buildings  
1617 Cole Boulevard  
Golden, Co. 80401

**Passive Solar Industries Council**

1090 Vermont Avenue, Suite 1200  
Washington, DC 20005

**Example Tables**

**Examples of Heat Energy Savings  
Added Insulation**  
1,500 sf Single Story House

	Base Case	20%	40%	60%
<b>R-values</b>				
Ceiling/Roof	31	37	45	61
Walls	19	23	28	39
Basement Wall	11	13	16	24
Glass	1.8	1.8	2.7	3.3
<b>Air Changes/Hour</b>	0.50	0.38	0.35	0.27
<b>Glass Area (percent of total floor area)</b>				
West	3.0%	2.0%	2.0%	2.0%
North	3.0%	4.0%	4.0%	4.0%
East	3.0%	4.0%	4.0%	4.0%
South	3.0%	3.0%	3.0%	3.0%
<b>Percent Solar Savings</b>	8%	10%	13%	17%
<b>Performance (Btu/yr-sf)</b>				
Conservation	51,037	43,146	33,622	23,854
Auxiliary Heat	47,085	38,669	29,237	19,776
Cooling	4,555	1,356	1,197	205

**Examples of Heat Energy Savings  
Suntempered**  
1,500 sf Single Story House

	Base Case	20%	40%	60%
<b>R-Values</b>				
Ceiling/Roof	31	34	41	52
Walls	19	21	25	32
Basement Wall	11	12	15	19
Glass	1.8	1.8	1.8	2.7
<b>Air Changes/Hour</b>	0.50	0.46	0.28	0.29
<b>Glass Area (percent of total floor area)</b>				
West	3.0%	2.0%	2.0%	2.0%
North	3.0%	4.0%	4.0%	4.0%
East	3.0%	4.0%	4.0%	4.0%
South	3.0%	6.7%	6.7%	6.7%
<b>Solar System Size (square feet)</b>				
South Glass	45	100	100	100
<b>Percent Solar Savings</b>	8%	19%	23%	29%
<b>Performance (Btu/yr-sf)</b>				
Conservation	51,037	47,976	38,198	28,127
Auxiliary Heat	47,085	38,639	29,202	19,741
Cooling	4,555	956	690	0

**Summary:** Insulation values and tightness of the house (as measured in ACH) have been increased. The window area has been slightly decreased on the west, increased slightly on the east and north, and increased significantly on the south.

**Examples of Heat Energy Savings  
Passive Solar—Direct Gain**  
1,500 sf Single Story House

	Base Case	20%	40%	60%
<b>R-values</b>				
Ceiling/Roof	31	30	37	46
Walls	19	18	23	29
Basement Wall	11	10	14	17
Glass	1.8	1.8	1.8	2.7
<b>Air Changes/Hour</b>	0.50	0.48	0.37	0.34
<b>Glass Area (percent of total floor area)</b>				
West	3.0%	2.0%	2.0%	2.0%
North	3.0%	4.0%	4.0%	4.0%
East	3.0%	4.0%	4.0%	4.0%
South	3.0%	10.5%	11.1%	12.0%
<b>Added Thermal Mass</b>				
Percent of Floor Area	0.0%	20.9%	24.6%	30.0%
<b>Solar System Size (square feet)</b>				
South Glass	45	157	166	180
Added Thermal Mass	0	313	368	450
<b>Percent Solar Savings</b>	8%	26%	32%	41%
<b>Performance (Btu/yr-sf)</b>				
Conservation	51,037	52,506	43,158	33,626
Auxiliary Heat	47,085	38,551	29,164	19,696
Cooling	4,555	646	316	0

**Summary:** Insulation and tightness have been increased. South-facing glazing has been substantially increased. For these examples, added mass area is assumed to be six times the added south glass area.

**Examples of Heat Energy Savings  
Passive Solar—Sunspace  
1,500 sf Single Story House**

	Base Case	20%	40%	60%
<b>R-Values</b>				
Ceiling/Roof	31	30	35	40
Walls	19	18	22	25
Basement Wall	11	10	13	14
Glass	1.8	1.8	1.8	1.8
<b>Air Changes/Hour</b>	0.50	0.48	0.45	0.30
<b>Glass Area (percent of total floor area)</b>				
West	3.0%	2.0%	2.0%	2.0%
North	3.0%	4.0%	4.0%	4.0%
East	3.0%	4.0%	4.0%	4.0%
South (windows)	3.0%	3.0%	3.0%	3.0%
Sunspace	0.0%	4.6%	8.1%	13.0%
<b>Solar System Size (square feet)</b>				
South Glass	45	45	45	45
Sunspace Glass	0	69	121	195
Sunspace Thermal Mass	0	208	363	586
<b>Percent Solar Savings</b>	8%	26%	37%	51%
<b>Performance (Btu/yr-sf)</b>				
Conservation	51,037	52,313	46,739	40,544
Auxiliary Heat	47,085	38,575	29,090	19,564
Cooling	4,555	1,564	1,451	536

**Summary:** Insulation (for the 40 and 60% savings) and tightness have been increased. North and east-facing glazing have been increased slightly. The sunspace assumed here is semi-enclosed (surrounded on three sides by conditioned rooms of the house, as in Figure SSD1 of the worksheets), with its south glazing tilted at 50 degrees. The common wall is a thermal mass wall made of masonry. Sunspace glazing is assumed to be double.

**Examples of Heat Energy Savings  
Passive Solar—Thermal Storage Wall  
1,500 sf Single Story House**

	Base Case	20%	40%	60%
<b>R-Values</b>				
Ceiling/Roof	31	30	34	37
Walls	19	18	21	23
Basement Wall	11	10	12	14
Glass	1.8	1.8	1.8	1.8
<b>Air Changes/Hour</b>	0.50	0.48	0.46	0.38
<b>Glass Area (percent of total floor area)</b>				
West	3.0%	2.0%	2.0%	2.0%
North	3.0%	4.0%	4.0%	4.0%
East	3.0%	4.0%	4.0%	4.0%
South	3.0%	3.0%	3.0%	3.0%
Thermal Storage Wall	0.0%	5.9%	10.6%	17.0%
<b>Solar System Size (square feet)</b>				
South Glass	45	45	45	45
Thermal Storage Wall	0	88	159	255
<b>Percent Solar Savings</b>	8%	26%	40%	55%
<b>Performance (Btu/yr-sf)</b>				
Conservation	51,037	52,417	48,582	44,251
Auxiliary Heat	47,085	38,604	29,117	19,578
Cooling	4,555	1,200	826	0

**Summary:** In the case of a Thermal Storage Wall, south-facing glazing and thermal mass are incorporated together. The estimates here assume a 12-inch thick concrete Thermal Storage Wall with a selective surface and single glazing.

**Cooling Potential  
Basecase 4,555 Btu/yr-sf**

Strategy	Energy Savings (Btu/yr-sf)	Percent Savings
No Night Ventilation <sup>1</sup>		
without ceiling fans	0	0%
with ceiling fans	1,320	29
Night Ventilation <sup>1</sup>		
without ceiling fans	1,200	26
with ceiling fans	2,290	50
High Mass <sup>2</sup>		
without ceiling fans	350	8
with ceiling fans	300	7

1 With night ventilation, the house is ventilated at night when temperature and humidity conditions are favorable.

2 A "high mass" building is one with a thermal mass area at least equal to the house floor area.



## Technical Basis for the Builder Guidelines

### *How the Builder Guidelines Were Produced*

The text of the Builder Guidelines book is generated by merging two computer files. The first is a word-processor file containing the text; it does not change from location to location. The second contains numbers and text and is location dependent. This second file is produced by running a computer program that calculates performance numbers based on long-term monthly weather and solar data compiled by the National Oceanic and Atmospheric Administration for a particular location. The merge operation slots the numbers and text in the second file into their correct locations in the first file. This is then laser printed to produce the camera-ready manuscript.

### *More than a Decade of Experience*

The concentrated effort of research, design, construction, monitoring, and evaluation of actual buildings that started at the First Passive Solar Conference in Albuquerque in 1976 has continued up to the present. It is estimated that more than 200,000 passive solar homes have been built in the United States during this time. This wealth of experience has been reviewed by SERI, the Technical Committee of PSIC, and by the Standing Committee on Energy of the National Association of Home Builders and is distilled into these Guidelines.

### *Analysis Procedures*

The analysis procedures used throughout the Guidelines were developed using simple, well-established methods for estimating the performance of passive solar heating and natural cooling strategies. These procedures (described below) were developed at the

Los Alamos National Laboratory with funding from the U.S. Department of Energy Solar Buildings Program. See the references for more information.

### *Annual Heat Loss (Worksheet I)*

The heat-loss calculation is based on a straightforward summation of the traditional elements that make up the building heat-loss coefficient (excluding the solar components). The worksheet procedure estimates the annual heat loss by multiplying the heat-loss coefficient by annual degree days (times 24 to convert from days to hours). Degree days for each month were determined using an appropriate base temperature that accounts for an assumed thermostat setting of 70 degrees, an assumed internal heat generation of 36 Btu/day per sq ft of floor area, and the total building loss coefficient. This forms the basis of the table of heating degree day multipliers. The result of the worksheet is an estimate of the annual heat required to maintain comfort, excluding both positive and negative effects resulting from the solar components. In this estimate, no solar heating credit is given to east, west, and north windows, because it is assumed that these will be protected by vegetation or other shading in accordance with the Builder Guideline recommendations. This is a conservative assumption because there will always be some solar gain through these windows.

### *Annual Auxiliary Heat (Worksheet II)*

The tables of passive solar savings fractions are calculated using the solar load ratio (SLR) method (references 1 and 2). Monthly solar savings fraction (SSF) values are determined using correlation fits to the results of hourly computer simulation calculations for a variety of climates. These 12 values are converted into an annual value and entered into worksheet Tables F1-F4. The SLR method gives answers that agree within about 5% of the hourly computer simulations and within 11% of the measured passive solar performance of 55 buildings monitored under the Solar Buildings Program. The SSF estimates account properly for both solar gains and heat losses through the solar aperture and, thus, correct for omitting the solar components from the calculation of annual heat loss.

### *Temperature Swing (Worksheet III)*

The temperature swing estimate on worksheet III is based on the diurnal heat capacity (dhc) method (reference 3). The method is an analytic procedure in which the total heat stored in the building during one day is estimated by summing the effective heat storage potential of all the various materials in the building for a 24-hour periodic cycle of solar input. Rooms with direct gain are assumed to have radiative coupling of the solar heat to the mass. Rooms connected to rooms with direct gain are assumed to have convective coupling, which is rather less effective, especially for massive elements. The dhc of the sheetrock, framing, and furniture is approximated as 4.5 or 4.7 Btu/°F per sq ft of floor area. Worksheet Tables H1 and H2 list the increased value of diurnal heat capacity for various conventional materials that are often used to provide extra heat storage, assuming these materials replace sheetrock.

The only numbers in worksheet III that are location dependent are the comfort factors, taken from Table I. The direct-gain comfort factor is 61% of the solar gain transmitted through vertical, south-facing double glazing on a clear January day. The driving effect of sunspaces and vented Trombe walls is assumed to result in one-third this value, based on data from monitored buildings. The origin of the 61% factor is described in the references.

### **Annual Auxiliary Cooling (Worksheet IV)**

The purpose of including the summer cooling estimates in the Builder Guidelines is to (1) determine if design elements added to promote passive solar heating will cause excessive summer cooling loads and (2) provide a rough estimate of the effectiveness of solar shading and natural cooling strategies. The analysis method is based on a modified monthly degree-day procedure in which the day is divided into day and night periods (reference 4). All estimates are derived from correlations based on hourly computer simulations. Solar, conduction, and internal gains are estimated for each half-day period in each month. Delay factors are used to account for heat carryover from day to night and night to day. The results are estimates of annual sensible cooling delivered by the air conditioner and do not include latent loads.

Because the the original Los Alamos monthly procedure is too complex to be implemented in a worksheet, a simplified procedure is adopted on worksheet IV. Heat Gain Factors and Internal Gain Factors in Tables L and N are the calculated annual incremental cooling loads resulting from a one-unit incremental change in the respective heat input parameter (that is, a one-unit change in UA, glazing area, or number of bedrooms). The combined heat load resulting from all inputs is summed and then adjusted for thermal mass and ventilation. This correction includes a constant required to match the calculated cooling load of the base-case building. This linearized procedure gives accurate estimates for cooling loads that are less than about 150% of the base-case building; however, it

underestimates very large cooling loads in poorly designed buildings.

The adjustment factors for ventilation properly account for maintaining comfort in hot and humid climates. Ventilation is restricted to times when the outside dew-point temperature is less than 62 °F. This restriction avoids ventilation when high humidity might cause discomfort.

### **Not for Sizing Equipment**

All heating and cooling values given in the Builder Guidelines Tables and numbers calculated using the worksheets are for annual heat delivered or removed by the mechanical heating or cooling system. You cannot directly use these numbers for sizing the capacity of this equipment. The methods developed by the American Society of Heating, Refrigerating, and Air Conditioning Engineers for sizing equipment are well-established and are recommended. The purpose of the guidance provided in these booklets is to minimize the operating time and resources consumed by this equipment.

### **Using the Worksheets in Nearby Locations**

The applicability of worksheets I and II can be extended somewhat by using the base-65 °F degree-day value for a site which is close to the location for which the worksheet tables were generated. We recommend limiting such applications to sites where the annual heating degree-days are within plus or minus 10% of the parent location and where it is reasonable to assume that the solar radiation is about the same as in the parent location. The procedure is simple: Use the measured base-65 °F degree-day value in worksheet I, line F, instead of the degree-day value for the parent location.

Worksheet III depends only slightly on location. The only variables are the Comfort Factors in Table I, which only change with latitude. Thus, this worksheet can be used anywhere within 4 degrees of latitude of the parent location.

The cooling estimate obtained from worksheet IV is specific to the location. Within the same vicinity and within plus

or minus 20%, the result could be adjusted, based on a ratio of cooling degree days. However, this adjustment is not done automatically within the worksheet.

### **Getting Data**

Heating and cooling degree-day data can be obtained from the National Climatic Center, Asheville, NC. Refer to Climatology of the United States No. 81 which lists monthly normals for the period 1951-1980 on a state-by-state basis. More than 2400 locations are listed in this data base.

## References

1. J. Douglas Balcomb, Robert W. Jones, Robert D. McFarland, and William O. Wray, "Expanding the SLR Method", *Passive Solar Journal*, Vol. 1, No. 2, 1982, pp. 67-90. Available from the American Solar Energy Society, 2400 Central Ave. Unit B-1, Boulder, CO 80301.
2. J. Douglas Balcomb, Robert W. Jones, Robert D. McFarland, and William O. Wray, **Passive Solar Heating Analysis**, American Society of Heating, Refrigerating, and Air-Conditioning Engineers, 1984. Available from ASHRAE, 1719 Tullie Circle, NE, Atlanta, GA 30329.
3. J. Douglas Balcomb and William O. Wray, **Passive Solar Heating Analysis, Supplement One, Thermal Mass Effects and Additional SLR Correlations**, American Society of Heating, Refrigerating, and Air Conditioning Engineers, 1987. See ASHRAE address above.
4. Robert D. McFarland and Gloria Lazarus, **Monthly Auxiliary Cooling Estimation for Residential Buildings**, LA-11394-MS, Los Alamos National Laboratory, Los Alamos, NM 87545, 1989.
5. J. Douglas Balcomb and Alexander B. Lekov, **Algorithms for Builder Guidelines**, SERI/TP-254-3492, Solar Energy Research Institute, Golden CO. Also contained in the Proceedings of the 14th Passive Solar Conference, Denver, June 19-23, 1989. See ASES address above.

Note: This is a generic example to explain how to fill out the worksheets. For an example specific to this book, refer to the worked example on the prior pages. The actual house design used for both examples is the same, but specific numerical values will be different.

**Anytown,  
USA**

**Anytown, USA**

# Introduction

## Purpose

The purpose of the Any Town, USA section is to explain how to use the passive solar worksheets in the Passive Solar Design Strategies: Guidelines for Home Building. Separate Worksheets booklets are available for specific locations throughout the continental USA. Each booklet contains detailed technical data for a specific location. Although the example presented in this booklet is for a moderate mid-Atlantic climate, the procedure is presented in a general manner and is intended to be used for all locations.

## General Description of Worksheets

The Worksheets booklet for each location provides an easy-to-use calculation procedure, allowing the designer to estimate the performance level of a particular building design and compare it against a base-case performance level or against the performance of the builder's more conventional house.

A separate worksheet is provided for each of four separate performance levels performance level and associated target. These are described below:

*Worksheet I: Conservation Performance Level:* the estimated heat energy needed by the building each year from both the solar and auxiliary heating systems. The units are Btu/yr-sf.

*Worksheet II: Auxiliary Heat Performance Level:* the estimated heat that must be provided each year by the auxiliary heating system. This worksheet accounts for the solar savings. The units are Btu/yr-sf.

*Worksheet III: Thermal Mass/Comfort:* the temperature swing expected on a clear winter day with the auxiliary heating system not operating. The units are °F.

*Worksheet IV: Summer Cooling Performance Level:* the estimated annual cooling load of the building. The units are Btu/yr-sf.

The estimates from Worksheets I and II are based on a heating thermostat setting of 70°F. The estimates from Worksheet IV are based on a cooling thermostat setting of 78°F with no ceiling fans and 82°F with ceiling fans.

The worksheets are supported by a number of data tables. The data tables are given a letter designation and are referenced when applicable next to each worksheet entry.

A description and drawings of the example building are provided below, followed by completed worksheets. Data tables have also been included when appropriate.

Each step of the worksheets is then explained in detail.



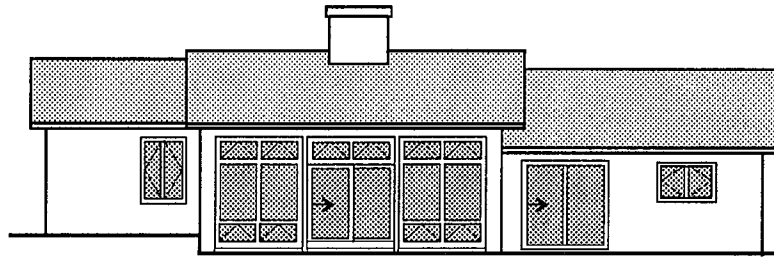

SOUTH ELEVATION

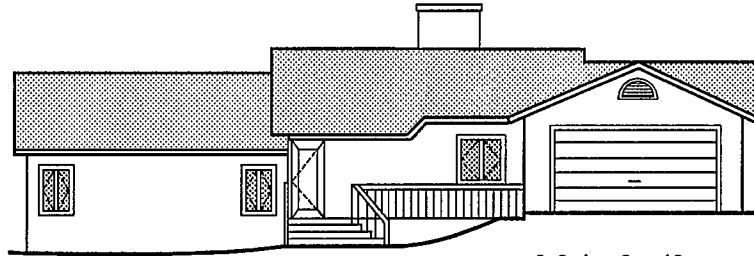

NORTH ELEVATION

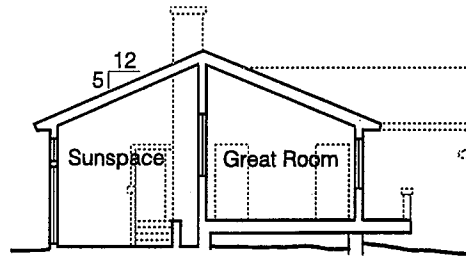

ABOVE GRADE SECTION

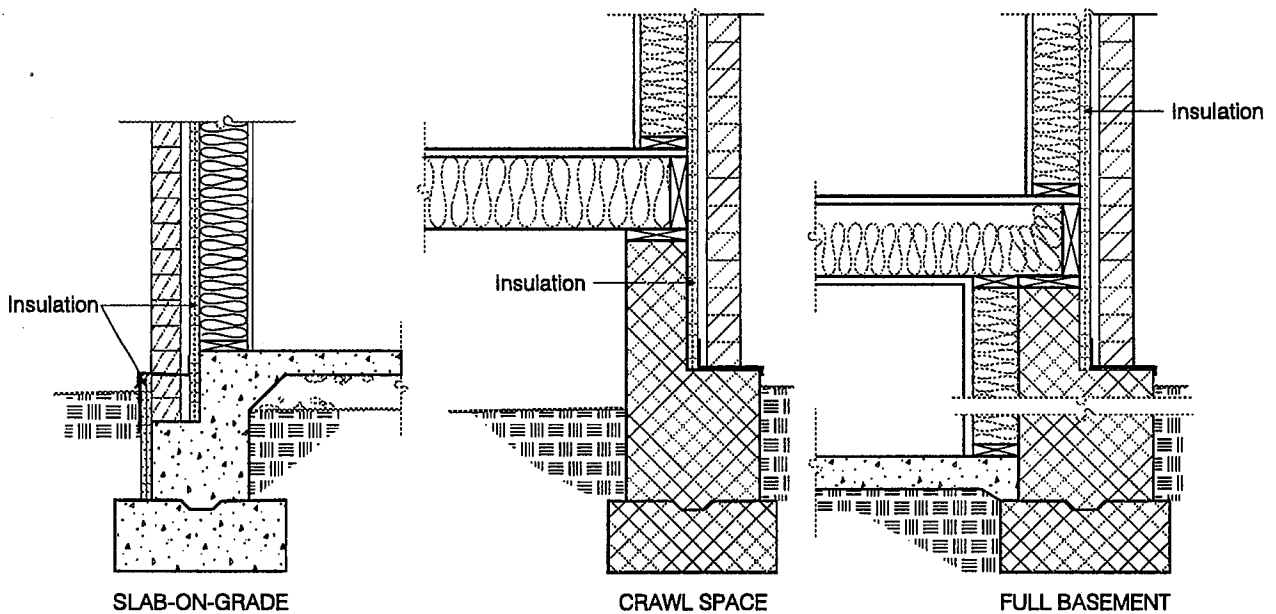

SLAB-ON-GRADE

CRAWL SPACE

FULL BASEMENT

TYPES OF FOUNDATIONS

### General Project Information

Project Name <u>Example Building</u>	Floor Area <u>1,504 sf</u>
Location <u>Anytown, USA</u>	Date _____
Designer _____	_____

### Worksheet I: Conservation Performance Level

#### A. Envelope Heat Loss

	Construction Description	Area		R-value [Table A]		Heat Loss	
Ceilings/roofs	R-38 in Attic	1084	+	35.9	=	30	
	R-30 in Cathedral Ceiling	420	+	24.5	=	17	
Walls	R-19+ R-7 Sheathing in Rigid Insulation	992	+	24.7	=	40	
	R-19 in Garage	140	+	17.7	=	8	
Insulated Floors	R-19 in Floor over Vented Crawlspace	784	+	25.8	=	30	
			+		=		
Non-solar Glazing	Double Glazed Wood Frame, 1/2" air gap	52	+	1.8	=	29	
	- Low-E (e ≤ .40)		+		=		
Doors	Metal with Foam Core	40	+	5.9	=	7	
			+		=		
						161	Btu/°F-h
						Total	

#### B. Foundation Perimeter Heat Loss

	Description	Perimeter		Heat Loss Factor [Table B]		Heat Loss	
Slabs-on-Grade	R-7	82	X	0.30	=	25	
Heated Basements			X		=		
Unheated Basements			X		=		
Perimeter Insulated Crawlspace			X		=		
						25	Btu/°F-h
						Total	

#### C. Infiltration Heat Loss

$$\frac{12,483}{\text{Building Volume}} \times \frac{0.50}{\text{Air Changes per Hour}} \times .018 = 112 \text{ Btu/°F-h}$$

#### D. Total Heat Loss per Square Foot

$$24 \times \frac{298}{\text{Total Heat Loss (A+B+C)}} + \frac{1504}{\text{Floor Area}} = 4.76 \text{ Btu/DD-sf}$$

#### E. Conservation Performance Level

$$\frac{4.76}{\text{Total Heat Loss per Square Foot}} \times \frac{3703}{\text{Heating Degree Days [Table C]}} \times \frac{0.97}{\text{Heating Degree Day Multiplier [Table C]}} = 17,097 \text{ Btu/yr-sf}$$

#### F. Comparison Conservation Performance (From Previous Calculation or from Table D)

$$\frac{17,097}{24} = 25,360 \text{ Btu/yr-sf}$$

**Compare Line E to Line F**



## Worksheet I: Conservation Performance Level

Worksheet I is essentially a heat loss calculation, similar to the type of calculation made to size heating and cooling equipment. The major difference is that the calculation does not consider heat loss through any of the passive solar systems. The following building components in the example building are not considered in the calculation:

- Heat loss through direct gain solar glazing.
- Heat loss through walls and windows that separate the house from the sunspace. If the example building had Trombe walls or water walls, heat loss through these passive solar systems would also be excluded from the calculation.

Heat loss from the passive solar energy systems is excluded since the solar savings fractions in Worksheet II take these losses into account.

### Step A. Envelope Heat Loss

The first step is to calculate the heat loss through the building envelope. The building envelope consists of all walls, roofs, floors, non-solar windows and doors that enclose the conditioned space of the house.

Heat loss for each envelope component is calculated by dividing the surface area of the component by the total R-value. The total envelope heat loss is the sum of the heat loss for all of the envelope components.

Table A in the Worksheets booklet contains R-values that may be used in the calculation. There are actually five separate tables labeled A1, A2, A3, A4 and A5. A separate table is provided for ceilings/roofs, walls, floors, windows and doors. The R-values in these tables include the thermal resistance of both the insulation and other materials that typically make up the construction assembly such as exterior sheathing and sheetrock. They also account for framing members that penetrate the insulation and reduce the effectiveness.

### Ceilings/Roofs

There are two types of ceiling/roof construction in the example building. R-38 mineral insulation is located in an attic space, and R-30 insulation is located in the framed cathedral ceiling. The total R-value is selected from Table A1 for each ceiling/roof component. The values in Table A1 account for the buffering effect of the attic (when applicable), the ceiling material (sheetrock) and the effect of framing.

Attic Construction	Insulation R-value				
	R-30	R-38	R-49	R-60	
	27.9	35.9	46.9	57.9	
Framed Construction	Insulation R-value				
	R-19	R-22	R-30	R-38	
	2x6 at 16"oc	14.7	15.8	16.3	-
	2x6 at 24"oc	15.3	16.5	17.1	-
	2x8 at 16"oc	17.0	18.9	20.6	21.1
	2x8 at 24"oc	17.6	19.6	21.6	22.2
	2x10 at 16"oc	18.1	20.1	24.5	25.7
2x10 at 24"oc	18.4	20.7	25.5	26.8	
2x12 at 16"oc	18.8	21.0	25.5	30.1	
2x12 at 24"oc	19.0	21.4	27.3	31.4	

The area and R-value of the two different types of construction are entered on two lines of the table under "ceilings/roofs" and the heat loss is calculated by dividing the surface area by the total R-value. Note that the ceiling over the sunspace is not included in this calculation.

**Walls**

There are two types of wall construction in the example building. The typical exterior wall is of 2x6 wood frame construction with R-19 mineral insulation in the cavity. An insulating sheathing with an R-7 rating is attached to the exterior surface of the framing. The wall is finished with 1/2 inch sheetrock on the inside and a brick veneer on the outside.

The second type of wall construction separates the house from the garage. This wall is also of 2x6 wood frame construction with R-19 in the cavity, but it does not have the insulating sheathing or the brick veneer. Note that the walls that separate the house from the sunspace are not included.

It is necessary to measure the surface area of each type of wall construction. The surface area may be determined by multiplying the length of wall by the average height and subtracting the area of doors and windows.

The R-value of each wall type is determined from Table A2 in the Worksheets booklet. The R-value of both wall types is 17.7 from the table, but since the first wall type has R-7 insulating sheathing, this is added to the value from the table so that 24.7 is used in the calculations. These R-values along with the associated areas are entered on two lines of the table and the heat loss is calculated by dividing each surface area by the corresponding R-value.

Single Wall Framing	Insulation R-value			
	R-11	R-13	R-19	R-25
2x4 at 16"oc	12.0	13.6	-	-
2x4 at 24"oc	12.7	13.9	-	-
2x6 at 16"oc	14.1	15.4	17.7	19.2
2x6 at 24"oc	14.3	15.6	18.2	19.8
Double Wall Framing	Total Thickness (inches)			
	8	10	12	14
	25.0	31.3	37.5	43.8

The R-value of insulating sheathing should be added to the values in this table.

**Floors**

Only the raised floor is considered in this step of the heat loss calculation; heat loss from the slab-on-grade floor is considered in Step B. There is one type of raised floor construction in the example building. R-19 mineral insulation is placed between 2x10 floor joists at 16 inches on center; the crawlspace beneath is ventilated.

The total R-value is selected from Table A3, which considers the buffering effect of the crawlspace as well as framing and the floor materials. The area and R-value is entered on one line of the table and the heat loss is calculated by dividing the area by the R-value.

Framing	Insulation R-value			
	R-11	R-19	R-30	R-38
2x6s at 16"oc	18.2	23.8	29.9	-
2x6s at 24"oc	18.4	24.5	31.5	-
2x8s at 16"oc	18.8	24.9	31.7	36.0
2x8s at 24"oc	18.9	25.1	33.1	37.9
2x10 at 16"oc	19.3	25.8	33.4	38.1
2x10 at 24"oc	19.3	26.1	34.4	39.8
2x12 at 16"oc	19.7	26.5	34.7	39.8
2x12 at 24"oc	19.6	26.7	35.5	41.2

These R-values include the buffering effect of a ventilated crawlspace or unconditioned basement.

Had there been different insulation conditions for the raised floor, an additional line of the table would be completed for each condition.

If the example building had insulated floors over a garage or unheated basement, these components would also be included in this step.

As an alternative to insulating between the floor joists, the perimeter walls of the crawlspace could have been insulated and floor insulation eliminated. When this technique is used, the perimeter heat loss method in Step B should be used. Step A only includes floors when insulation is placed in the floor assembly.

**Non-solar Glazing**

Next, heat loss from the non-solar glazing is calculated. Note that the passive solar direct gain glazing is not included. Also the windows that separate the house from the sunspace are not included.

The rough frame opening of each window is generally used for the window area. This is because the R-values presented in Table A4 and most heat loss data presented by window manufacturers is for the rough frame opening. Using the rough frame opening also makes it easier to estimate window areas since windows are usually specified on the plans in terms of the rough frame dimensions.

Windows in the example building are all double-pane wood windows with a 1/2 inch air space between the panes. The R-value for this window type is 2.1, selected from Table A4.

The non-solar window area is taken from the building plans. These values are entered in the table and the heat loss is calculated by dividing the window area by the window R-value. If the example building had more than one window type (different R-values), then additional lines of the table would be completed.

These values are entered in the table and the heat loss is calculated by dividing the door areas by the R-value. If the example building had more than one door type (different R-values), then additional lines of the table would be completed.

**Total**

The heat loss of all components of the building envelope is summed at the bottom of the table and this completes Step A of the worksheet.

**Doors**

The doors are the last component of the envelope to consider. The example building has two exterior doors: the main entrance and an additional door to the garage. These have a total surface area of 40 square feet and an R-value is selected from Table A5. Note that the door that separates the garage from the exterior is not included since the garage is unconditioned.

	A4-Windows		
	Air Gap		
	1/4 in.	1/2 in.	1/2 in. argon
Standard Metal Frame			
Single	.9		
Double	1.1	1.2	1.2
Low-e (e<=0.40)	1.2	1.3	1.3
Metal frame with thermal break			
Double	1.5	1.6	1.7
Low-e (e<=0.40)	1.6	1.8	1.8
Low-e (e<=0.20)	1.7	1.9	2.0
Wood frame with vinyl cladding			
Double	2.0	2.1	2.2
Low-e (e<=0.40)	2.1	2.4	2.5
Low-e (e<=0.20)	2.2	2.6	2.7
Low-e (e<=0.10)	2.3	2.6	2.9

These R-values are based on a 3 mph wind speed and are typical for the entire rough framed opening. Manufacture's data, based on National Fenestration Rating Council procedures, should be used when available. One half the R-value of movable insulation should be added, when appropriate.

A5-Doors	
Solid wood with Weatherstripping	2.2
Metal with rigid foam core	5.9

**Step B. Foundation Perimeter Heat Loss**

Foundation heat loss from slabs-on-grade, basements and insulated crawlspaces is estimated by multiplying the length of perimeter times an appropriate heat loss factor taken from Table B.

The dining area, kitchen and secondary bedrooms in the example house have slab-on-grade construction. R-7 insulation is installed around the perimeter.

The heat loss factor for the slab edge is 0.3, selected from Table B. The heat loss factor is multiplied by the perimeter to calculate the heat loss. The units of heat loss, using the perimeter method, are the same as for the building envelope calculated in the previous step. Note that sunspace slab is not included in this calculation. The slab edge perimeter adjacent to the crawlspace and the sunspace is also excluded.

**Table B—Perimeter Heat Loss Factors for Slabs-on-Grade and Unheated Basements (Btu/h-F-ft)**

Perimeter Insulation	Slabs-on-Grade	Heated Basements	Unheated Basements	Insulated Crawlspaces
None	0.8	1.3	1.1	1.1
R-5	0.4	0.8	0.7	0.6
R-7	0.3	0.7	0.6	0.5
R-11	0.3	0.6	0.5	0.4
R-19	0.2	0.4	0.5	0.3
R-30	0.1	0.3	0.4	0.2

When a raised floor assembly is not insulated, for instance, over crawlspaces insulated at the perimeter or basements, heat loss occurs primarily at the perimeter.

The example house does not have a basement or a heated crawlspace, but if it did, the foundation heat loss would be calculated by multiplying the perimeter of these elements by a heat loss factor selected from Table B.

When houses have heated basements, heat loss from basement walls located above grade would be included in Step A.

**Step C. Infiltration Heat Loss**

The heat loss from infiltration or air leakage is estimated by multiplying the building volume times the air changes per hour times a heat loss factor of 0.018.

The example building is estimated to have an infiltration rate of 0.50 based on local building experience.

The building volume is calculated by multiplying the average ceiling height by the conditioned floor area. In this example the average ceiling height is 8.3 ft. The conditioned floor area is 1,504 sf which does not include the garage or the sunspace. The resulting building volume is 12,483 cubic feet.

The units of infiltration heat loss are Btu/°F-h, the same as for the building envelope and the foundation perimeter.

**Step D. Total Heat Loss per Square Foot**

The total building heat loss is the sum of the heat loss for the building envelope (Step A), the foundation perimeter (Step B) and infiltration (Step C). For residences this value will range between 200 and 500. It represents the Btu of heat loss from the building envelope over the period of an hour when it is one °F colder outside than inside. This total heat loss, of course, does not include heat loss from the solar systems, including direct gain glazing.

The result of Step D, however, is the annual heat loss per degree day per square foot. This value is calculated by multiplying the total heat loss by 24 hours/day and dividing by the conditioned floor area.

**Step E. Conservation Performance Level**

Once the total heat loss per square foot is calculated, the conservation performance level may be calculated by multiplying the total heat loss per square foot (Step D) by the heating degree days times the heating degree day multiplier.

**C1-Heating Degree Days (Base 65°F)**

Raleigh-Durham

3,703

This value is from TMY weather tapes and should be used for Worksheet Calculations. It will vary from long term averages.

The heating degree days are selected from Table C1 and based on specific locations. The heating degree day multiplier is selected from Table C2 and is based on the total heat loss per square foot (Step D) and the passive solar glazing area per square foot of floor area (Worksheet II, Step A).

**C2-Heating Degree Day Multiplier**

Heat Loss per Square Foot	Passive Solar Glazing Area per Square Foot				
	.00	.05	.10	.15	.20
8.00	1.03	1.05	1.07	1.09	1.11
7.50	1.01	1.04	1.06	1.07	1.10
7.00	0.99	1.02	1.04	1.06	1.08
6.50	0.97	1.00	1.02	1.04	1.06
6.00	0.94	0.97	1.00	1.03	1.05
5.50	0.90	0.94	0.98	1.00	1.03
5.00	0.86	0.91	0.95	0.98	1.01
4.50	0.82	0.87	0.92	0.96	0.99
4.00	0.77	0.83	0.88	0.92	0.96
3.50	0.72	0.78	0.83	0.88	0.93

The conservation performance level for the example building is compared to the base case conservation performance level in the next step.

**Step F. Comparison Conservation Performance**

The conservation performance level for the proposed design may be compared to the base case performance level for the area, given in Table D.

**Table D-Base Case Conservation Performance (Btu/yr-sf)**

Base Case

25,380

Alternatively, the conservation performance level may be compared to other building designs considered by the builder to be typical of the area. In this case, the worksheets would first be completed for the typical design and the results of these calculations would be entered in Step F.

If the conservation performance level of the proposed building (Step E) is greater than the base case or typical-design conservation performance level, the designer should consider additional building insulation or reduced non-solar glass area.

**Worksheet II: Auxiliary Heat Performance Level**

**A. Projected Area of Passive Solar Glazing**

Solar System Reference Code	Rough Frame Area		Net Area Factor		Adjustment Factor [Table E]		Projected Area
DGCI	88	×	0.80	×	.98	=	69
SSCI	208	×	0.80	×	.98	=	163
		×	0.80	×		=	
		×	0.80	×		=	
		×	0.80	×		=	
		×	0.80	×		=	
		×	0.80	×		=	
	296						232
	Total Area						Total Projected Area

$$\frac{232}{\text{Total Projected Area}} \div \frac{1504}{\text{Floor Area}} = \frac{.15}{\text{Total Projected Area per Square Foot}}$$

**B. Load Collector Ratio**

$$24 \times \frac{298}{\text{Total Heat Loss [Worksheet I]}} \div \frac{232}{\text{Total Projected Area}} = 30.83$$

**C. Solar Savings Fraction**

Solar System Reference Code	Projected Area		System Solar Savings Fraction [Table F]		
DGC1	69	×	.44	=	30.36
SSC1	163	×	.45	=	73.35
		×		=	
		×		=	
		×		=	
		×		=	
		×		=	

$$\frac{103.71}{\text{Total}} \div \frac{232}{\text{Total Projected Area}} = \frac{0.45}{\text{Solar Savings Fraction}}$$

**D. Auxiliary Heat Performance Level**

$$\left[ 1 - \frac{0.45}{\text{Solar Savings Fraction}} \right] \times \frac{17,097}{\text{Conservation Performance Level [Worksheet I, Step E]}} = \frac{9043}{\text{Btu/yr-sf}}$$

**E. Comparative Auxiliary Heat Performance** (From Previous Calculation or from Table G)

$$\frac{23,099}{\text{Btu/yr-sf}}$$

**Compare Line D to Line E**

## Worksheet II: Auxiliary Heat Performance Level

Worksheet II is used to estimate the savings from passive solar systems and to estimate the auxiliary heat performance level. This is the amount of heat that must be provided to the building each year after the solar savings have been accounted for.

The example building has two solar systems: direct gain south glazing and a sunspace.

### Step A. Projected Area of Passive Solar Glazing

The first step is to calculate the projected area of the solar glazing. The projected area of passive solar glazing is the area projected on a plane facing true south (the actual glazing may be oriented slightly east or west of true south). The projected solar glazing also accounts for sloped glazing in certain types of sunspaces.

For most solar systems the projected area may be calculated by multiplying the actual glazing area times an adjustment factor taken from Table E.

Alternatively, the projected area may be determined by making a scaled elevation drawing of the building, looking exactly north. Surface areas may then be measured from the scaled elevation drawing. This concept is illustrated in the figure below.

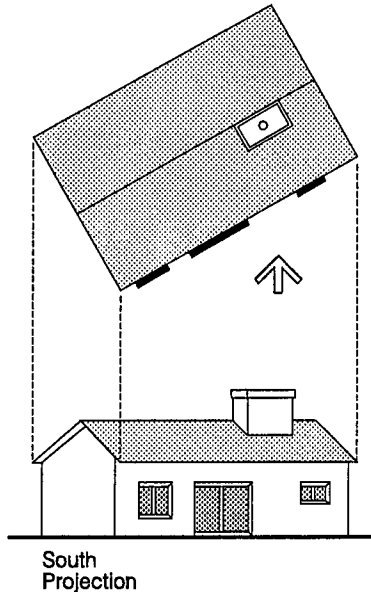

**Projected Area of Passive Solar Glazing**  
The solar savings fraction is based on the projected area of solar glazing.

The worksheet allows the user to enter the rough frame area of solar glazing, since it is generally easier to measure this. The rough frame area is multiplied by a net area factor of 0.80 to account for window framing and mullions. If the net glass area is entered, the net area factor is 1.00.

The example building has two separate passive solar systems: direct gain and a sunspace. This means that two lines of the table must be completed. If the example building had other types of solar systems, for instance Trombe walls or water walls, additional lines in the table would be completed.

In the first column, the reference code for each type of solar system is entered along with a description of the system.

The reference codes are shown on Tables F1 through F4 for various types of solar systems. More information about the system types is provided in the discussion under Step C of this worksheet. The reference code for the direct gain system is "DGC1" because night insulation is not proposed. The reference code for the sunspace is "SSC1" since all the sunspace glazing is vertical.

The south wall of the example building actually faces 10° east of south because of site conditions. The adjustment factor is therefore 0.98 for both solar systems as selected from Table E. Each solar system area is multiplied by the net area factor and the appropriate adjustment factor to calculate the projected area. Both the total projected area and the total area are summed at the bottom of the table.

Degrees off True South	Solar System Type		
	DG, WW, SSC	SSA, SSD	SSB, SSE
0	1.00	0.77	0.75
5	1.00	0.76	0.75
10	0.98	0.75	0.74
15	0.97	0.74	0.73
20	0.94	0.72	0.70
25	0.91	0.69	0.68
30	0.87	0.66	0.65

The last part of Step A is to divide the total projected area by the conditioned floor area, giving the total projected area per square foot. This value is used in Worksheet I, Step E to determine the heating degree day multiplier.

**Step B. Load Collector Ratio**

The load collector ratio is calculated by taking the total heat loss from Worksheet I, Step D and multiplying this value times 24 (hours/day) and dividing by the total projected area of the solar glazing calculated in the previous step.

**Step C. Solar Savings Fraction**

The next step is to calculate the solar savings fraction for the building. This is calculated as a weighted average of the solar savings fraction for the separate passive solar systems. The weightings are based on projected area.

The solar systems used in this step should be identical to those used above in Step A. The first two columns are simply carried down from the first and last columns in Step A.

The solar savings fraction for each individual system is taken from Tables F1 through F4 based on the load collector ratio calculated in Step B and the type of solar system. Table F1 is for direct gain systems, Table F2 for thermal storage walls, Table F3 for water walls and Table F4 for sunspaces. There are multiple columns in each table that account for system design features such as night insulation or selective surfaces.

A reference code, for instance "DGC1", is also provided for each solar system variation. These references are entered on the worksheet "Solar System Reference Code". They are also a key to additional information about each solar system as provided in *Passive Solar Heating Analysis* and other reference manuals.

Load Collector Ratio	F1-Direct Gain		
	DGC1 Double Glazing	DGC2 Low-e Glazing	DGC3 R-9 Night Insulation
200	0.10	0.11	0.13
155	0.13	0.14	0.17
100	0.18	0.20	0.24
80	0.22	0.25	0.30
60	0.28	0.31	0.38
50	0.32	0.36	0.44
45	0.34	0.39	0.47
40	0.37	0.43	0.51
35	0.40	0.47	0.56
30	0.44	0.52	0.62
25	0.49	0.58	0.69
20	0.55	0.65	0.77
15	0.62	0.74	0.85

Load Collector Ratio	F4-Sunspaces				
	SSA1	SSB1	SSC1	SSD1	SSE1
200	0.17	0.14	0.11	0.19	0.15
155	0.20	0.17	0.14	0.23	0.19
100	0.26	0.22	0.19	0.30	0.26
80	0.30	0.25	0.23	0.35	0.30
60	0.35	0.30	0.28	0.42	0.36
50	0.39	0.34	0.32	0.46	0.40
45	0.42	0.36	0.35	0.49	0.43
40	0.44	0.39	0.38	0.52	0.46
35	0.48	0.42	0.41	0.56	0.49
30	0.52	0.46	0.45	0.60	0.54
25	0.56	0.50	0.50	0.65	0.59
20	0.62	0.56	0.57	0.72	0.65
15	0.70	0.64	0.65	0.79	0.73

The solar savings fraction for each system is multiplied by the projected area and totaled at the bottom of the table. This total is then divided by the total projected area from Step A to calculate the weighted average solar savings fraction for the whole building.

The solar savings fractions are based on reference designs. The assumptions made about these reference designs are summarized below.

**Direct Gain**

The direct gain reference designs are all assumed to have double-pane glass and sufficient heat storage to limit the clear day temperature swing to 13°F. For the case with night insulation, the thermal resistance is assumed to be R-9.

**Trombe Walls**

The Trombe wall reference designs are all assumed to have double-pane glass. The mass wall is assumed to be 12 inches thick and constructed of masonry or concrete.

**Water Walls**

The water wall reference designs are all assumed to have double-pane glass. The water tank is assumed to be nine inches thick, extending continuously in front of the glazing surface. The space between the water tank and the glazing is assumed to be sealed.



## Sunspaces

Data is provided for five sunspace reference designs as illustrated on the following figure. Double glazing is assumed for all reference designs. Reference designs SSA1, SSB1 and SSD1 are assumed to have opaque end walls. All are assumed to have a concrete or masonry floor about six inches thick and a masonry or concrete common wall separating the sunspace from the living areas of the house. The glazing for designs SSA1 and SSD1 is assumed to be sloped at an angle of 50° from the horizon. The sloped glazing in designs B and E is assumed to be at an angle of 30°.

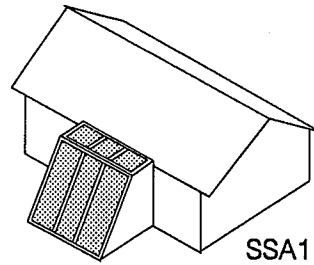

SSA1

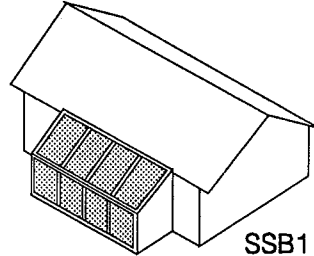

SSB1

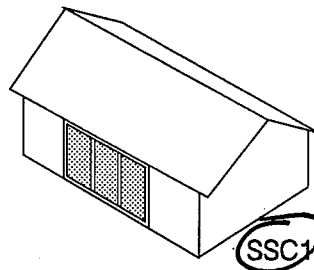

SSC1

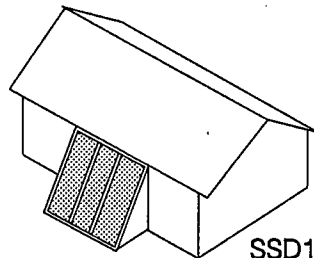

SSD1

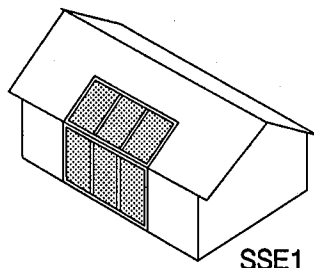

SSE1

### Sunspace Reference Designs

Data is provided for five types of sunspaces.

## Step D. Auxiliary Heat Performance Level

The auxiliary heat performance level is calculated by multiplying the conservation performance level from Worksheet I, Step E, times one minus the solar savings fraction, calculated in the previous step. This value represents the amount of heat that must be provided to the building by the auxiliary heating system(s).

## Step E. Comparative Auxiliary Heat Performance

The calculated auxiliary heat performance level may be compared to the performance level for a typical basecase building in the area. This may be taken from Table G and is 23,099 Btu/yr-sf.

Table G—Base Case Auxiliary Heat Performance (Btu/yr-sf)	
Base Case	23,099

Alternatively, the performance level may be compared to a previous worksheet calculation made for a typical builder house.

If the auxiliary heat performance level calculated in Step D were larger than the base case auxiliary heat performance, the designer should consider increasing the size of the solar systems, adding additional solar systems or increasing insulation levels.

**Worksheet III: Thermal Mass/Comfort**

**A. Heat Capacity of Sheetrock and Interior Furnishings**

	Floor Area		Unit Heat Capacity	=	Total Heat Capacity	
Rooms with Direct Gain	464	×	4.7	=	2181	
Spaces Connected to Direct Gain Spaces	949	×	4.5	=	4271	
					6452	Btu/°F
					Total	

**B. Heat Capacity of Mass Surfaces Enclosing Direct Gain Spaces**

Mass Description (include thickness)	Area		Unit Heat Capacity [Table H]	=	Total Heat Capacity	
Trombe Walls		×	8.8	=		
Water Walls		×	10.4	=		
Exposed Slab in Sun	103	×	13.4	=	1380	
Exposed Slab Not in Sun	137	×	1.8	=	247	
		×		=		
		×		=		
		×		=		
		×		=		
					1627	Btu/°F
					Total	

**C. Heat Capacity of Mass Surfaces Enclosing Spaces Connected to Direct Gain Spaces**

Mass Description (include thickness)	Area		Unit Heat Capacity [Table H]	=	Total Heat Capacity	
Trombe Walls		×	3.8	=		
Water Walls		×	4.2	=		
Face Brick 4"	111	×	3.7	=	411	
		×		=		
		×		=		
					411	Btu/°F
					Total	

**D. Total Heat Capacity**

$\frac{8490}{(A+B+C)}$  Btu/°F

**E. Total Heat Capacity per Square Foot**

$\frac{8490}{1504} = 5.6$  Btu/°F-sf  
 Total Heat Capacity      Conditioned Floor Area

**F. Clear Winter Day Temperature Swing**

	Total Projected Area [Worksheet II]		Comfort Factor [Table I]	=		
Direct Gain	69	×	866	=	59,754	
Sunspaces or	163	×	299	=	48,737	
Vented Trombe Walls						
	108,491	+	8490	=	12.8	°F
	Total		Total Heat Capacity			

**G. Recommended Maximum Temperature Swing**

$\frac{13}{}$  °F

Compare Line F to Line G

### Worksheet III: Thermal Mass/Comfort

This worksheet is used to calculate the thermal mass/comfort performance level, which is the temperature swing expected on a clear winter day with the auxiliary heating system not operating. A high temperature swing would indicate that inadequate thermal mass is provided in the building design, which not only creates discomfort but decreases solar heating performance.

The general procedure of the worksheet is to calculate the effective heat capacity of mass elements located within the conditioned space of the building. The total effective heat capacity is then combined with the direct gain projected area to estimate the clear winter day temperature swing. Note that thermal mass elements located within unconditioned spaces such as the sunspace are not included in this calculation.

#### Step A. Heat Capacity of Sheetrock and Interior Furnishings

The first step is to estimate the effective heat capacity associated with low-mass construction and interior furnishings. To complete this step it is necessary that two sub-areas be identified within the building: those areas that receive direct solar gains and those areas that are connected to rooms that receive direct solar gains. This is because the mass of sheetrock and furnishings located in direct gain rooms is more effective. Rooms that are separated from direct gain spaces by more than one door should not be included in either category.

In the example building, the master bedroom, dining area and kitchen are all direct gain spaces. The secondary bedrooms, bathrooms and master bedroom closet are directly connected to the direct gain spaces. The utility room and entry foyer are not considered in this calculation since they are not connected to a direct gain space. These areas are illustrated for the example building.

The direct gain space is multiplied by 4.7 and the spaces connected to direct gain spaces are multiplied by 4.5. These products are summed and represent the effective heat capacity associated with the sheetrock and interior furnishings.

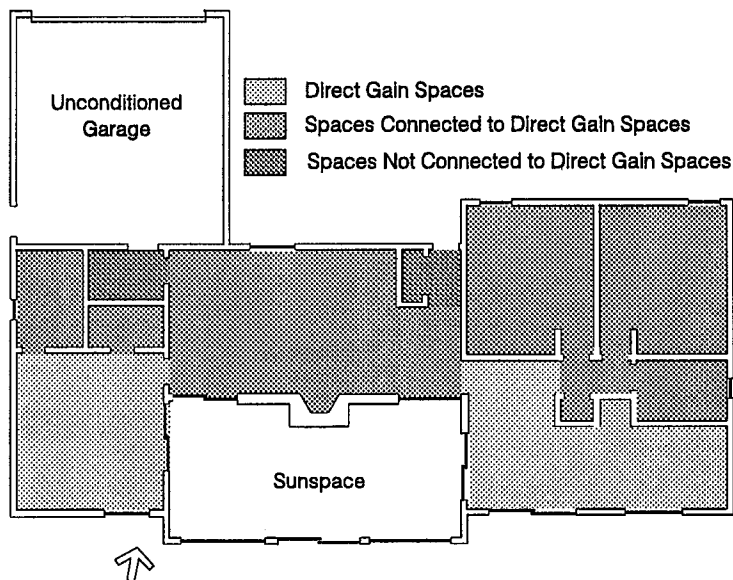

**Building Sub-areas for Calculating Effective Heat Capacity**  
Worksheet III requires that the building be divided into sub-areas.

**Step B. Heat Capacity of Mass Surfaces Enclosing Direct Gain Spaces**

The heat capacity of thermal mass elements (other than sheetrock and furnishings) that enclose the direct gain spaces is considered in this step. The surface area of each element is measured from the building plans and multiplied by the unit heat capacity. The unit heat capacity is printed directly in the table for Trombe walls, water walls, and exposed slabs-on-grade. The unit heat capacity for other mass elements is selected from Table H1. Note that thermal mass located in the sunspace is not included in this calculation.

Material	Thickness (inches)							
	1	2	3	4	6	8	12	
Poured Conc.	1.8	4.3	6.7	8.8	11.3	11.5	10.3	
Conc. Masonry	1.8	4.2	6.5	8.4	10.2	10.0	9.0	
Face Brick	2.0	4.7	7.1	9.0	10.4	9.9	9.0	
Flag Stone	2.1	4.8	7.1	8.5	8.6	8.0	7.6	
Builder Brick	1.5	3.7	5.4	6.5	6.6	6.0	5.8	
Adobe	1.3	3.2	4.8	5.5	5.4	4.9	4.8	
Hardwood	0.4	1.4	1.8	1.7	1.5	1.5	1.5	
Water	5.2	10.4	15.6	20.8	31.2	41.6	62.4	

Exposed slabs-on-grade include those with a surface of vinyl tile, ceramic tile or other materials that are highly conductive. Slabs that are covered with carpet should not be considered to be exposed. The exposed slab area should be further reduced, when appropriate, to account for throw rugs and furnishings.

The exposed slab area is then subdivided into two areas: that which is expected to be in the sun and that which is not. As a rule-of-thumb, slab area should be considered in the sun only when it is located directly behind south glazing. In any event, the slab area assumed to be in the sun should not exceed 1.5 times the south glass area.

In the example building, the slabs-on-grade located in the kitchen and dining room are located within direct gain spaces. Some of this area is considered to be in the sun and the remainder not. These surface areas are entered in the table and multiplied by the appropriate unit heat capacity. The products are then summed at the bottom of the table.

**Step C. Heat Capacity of Mass Surfaces Enclosing Spaces Connected to Direct Gain Spaces**

The same type of calculation is performed for mass surfaces that enclose spaces connected to direct gain spaces. The primary difference is the unit heat capacity figures taken from Table H2 instead of Table H1.

In the example building, the fireplace wall and hearth are considered in this category. This area and the unit heat capacity is entered in the table and multiplied by each other. This represents the total effective heat capacity of mass elements that enclose the spaces connected to direct gain spaces.

Material	Thickness (inches)							
	1	2	3	4	6	8	12	
Poured Conc.	1.7	3.0	3.6	3.8	3.7	3.6	3.4	
Conc. Masonry	1.6	2.9	3.5	3.6	3.6	3.4	3.2	
Face Brick	1.8	3.1	3.6	3.7	3.5	3.4	3.2	
Flag Stone	1.9	3.1	3.4	3.4	3.2	3.1	3.0	
Builder Brick	1.4	2.6	3.0	3.1	2.9	2.7	2.7	
Adobe	1.2	2.4	2.8	2.8	2.6	2.4	2.4	
Hardwood	0.5	1.1	1.3	1.2	1.1	1.0	1.1	

**Step D. Total Heat Capacity**

The total heat capacity is the sum of the heat capacity from Steps A, B and C. This represents the effective heat capacity of all thermal mass within the building.

**Step E. Total Heat Capacity per Square Foot**

The total heat capacity calculated in Step D is divided by the total floor area of the building to get the total heat capacity per square foot. The floor area used in this calculation should not include the sunspace or other unconditioned spaces. This value is calculated here for convenience, but it is not used until Worksheet IV is completed.

**Step F. Clear Winter Day Temperature Swing**

The clear winter day temperature swing is calculated in Step F. The projected area of all direct gain glazing is entered in the first row. This includes all direct gain systems either with or without night insulation. In the second row, the projected area of sunspace glazing and Trombe walls vented to the indoors is entered. Unvented Trombe walls and water walls are not included in this calculation since solar gain from these systems does not contribute to the temperature swing of the conditioned space.

The appropriate comfort factor is entered in the second column, selected from Table I. The projected areas are multiplied by the appropriate comfort factors and summed. This sum is then divided by the total heat capacity from Step D to yield the clear winter day temperature swing.

**Step G. Recommended Maximum Temperature Swing**

The comfort performance target for all locations is 13°F. If the comfort performance level calculated in Step F had been greater than 13°F, additional thermal mass should be added to the building or direct gain glazing should be reduced.

Direct Gain	866
Sunspaces and Vented Trombe Walls	299

### Worksheet IV: Summer Cooling Performance Level

#### A. Opaque Surfaces

Description	Heat Loss [Worksheet I]		Radiant Barrier Factor [Table J]		Absorptance [Table K]		Heat Gain Factor [Table L]	=	Load
Ceilings/roofs	30	×	1.00	×	0.47	×	47.0	=	663
	17	×	1.00	×	0.47	×	47.0	=	376
		×		×		×		=	
Walls	40	×	na		0.70	×	26.3	=	736
		×	na			×		=	
Doors	3.5	×	na		0.30	×	26.3	=	28
									1803
									Total

kBtu/yr

#### B. Non-solar Glazing

Description	Rough Frame Area		Net Area Factor		Shade Factor [Table M]		Heat Gain Factor [Table L]	=	Load
North Glass	40	×	0.80	×	0.67	×	37.0	=	995
		×	0.80	×		×		=	
East Glass	6	×	0.80	×	0.80	×	68.9	=	331
		×	0.80	×		×		=	
West Glass	6	×	0.80	×	0.80	×	73.2	=	351
		×	0.80	×		×		=	
Skylights		×	0.80	×		×		=	
		×	0.80	×		×		=	
									1677
									Total

kBtu/yr

#### C. Solar Glazing

Solar System Description	Rough Frame Area		Net Area Factor		Shade Factor [Table M]		Heat Gain Factor [Table L]	=	Load
Direct Gain	88	×	0.80	×	0.83	×	55.0	=	3214
		×	0.80	×		×		=	
Storage Walls		×	0.80	×		×		=	
		×	0.80	×		×		=	
Sunspace	208	×	0.80	×	0.83	×	12.2	=	1685
		×	0.80	×		×		=	
									4899
									Total

kBtu/yr

#### D. Internal Gain

$$\frac{2250}{\text{Constant Component [Table N]}} + \left( \frac{940}{\text{Variable Component [Table N]}} \times \frac{3}{\text{Number of Bedrooms}} \right) = 5070 \text{ kBtu/yr}$$

#### E. Cooling Load per Square Foot

$$1,000 \times \frac{13,449}{(A+B+C+D)} \div \frac{1504}{\text{Floor Area}} = 8942 \text{ Btu/yr-sf}$$

#### F. Adjustment for Thermal Mass and Ventilation

No night vent with no ceiling fan

$$\frac{736}{\text{[Table O]}} \text{ Btu/yr-sf}$$

#### G. Cooling Performance Level

$$\frac{8206}{(E-F)} \text{ Btu/yr-sf}$$

#### H. Comparison Cooling Performance (From Previous Calculation or from Table P)

$$\frac{9766}{\text{Btu/yr-sf}}$$

Compare Line G to Line H

### Worksheet IV: Summer Cooling Performance Level

Worksheet IV is used to calculate the summer cooling performance level. This is the heat that would need to be removed from the building by an air conditioner in order to maintain comfort during the summer.

The worksheet accounts for four sources of cooling load: opaque surfaces exposed to the sun, non-solar windows, passive solar systems, and internal gain. These loads are then adjusted to account for ventilation and thermal mass.

#### Step A. Opaque Surfaces

Not all opaque surfaces contribute to the cooling load of the building; only those surfaces exposed to sunlight (ceilings/roofs and walls) are included in the calculation. For each ceiling and wall surface listed on Worksheet I and exposed to the sun, the heat loss should be carried over to this worksheet along with a consistent description. This heat loss is then multiplied by a radiant barrier factor when appropriate (from Table J), the absorptance (from Table K) and a heat gain factor (from Table L). The end product of this calculation is an estimate of the annual cooling load that is associated with each surface in thousands of Btu per year (kBtu/yr).

Radiant Barrier	0.75
No Radiant Barrier	1.00

Color	Absorptance
Gloss White	0.25
Semi-gloss White	0.30
Light Green	0.47
Kelly Green	0.51
Medium Blue	0.51
Medium Yellow	0.57
Medium Orange	0.58
Medium Green	0.59
Light Buff Brick	0.60
Bare Concrete	0.65
Red Brick	0.70
Medium Red	0.80
Medium Brown	0.84
Dark Blue-Grey	0.88
Dark Brown	0.88

Ceiling/roofs	47.0
Walls and Doors	26.3
North Glass	37.0
East Glass	68.9
West Glass	73.2
Skylights	134.2
Direct Gain Glazing	55.0
Trombe Walls and Water Walls	12.2
Sunspaces	
SSA1	39.3
SSB1	39.3
SSC1	12.2
SSD1	39.3
SSE1	39.3

In the example building, four lines of the table are completed, two for the ceiling/roof types, one for the exterior walls with brick veneer and one for the entrance door. The wall that separates the house from the garage and the door in this wall are not included, since they are not exposed to sunlight.

The heat loss from each of these elements is carried over from Worksheet I. Note that the door heat loss is reduced by half since one of the two doors does not receive sunlight. The proposed building does not have a radiant barrier in the attic, so the radiant barrier factor is 1.00. Absorptances are selected based on the exterior building colors and the heat gain factors are from Table L.

#### Step B. Non-solar Glazing

Cooling load associated with the windows that do not face south, i.e. those that are not part of one of the solar systems, is calculated by multiplying the surface area in each orientation times the net area factor, a shade factor (from Table M) and a heat gain factor (from Table L). This calculation gives the annual cooling load for each non-solar glazed surface. The total for the building is the sum of the cooling load for each surface.

Projection Factor	South	East	North	West
0.00	1.00	1.00	1.00	1.00
0.20	0.83	0.93	0.93	0.93
0.40	0.63	0.81	0.81	0.81
0.60	0.49	0.71	0.70	0.68
0.80	0.35	0.60	0.61	0.56
1.00	0.30	0.50	0.54	0.45
1.20	0.24	0.40	0.46	0.38

Multiply by 0.8 for low-e glass, 0.7 for tinted glass and 0.6 for low-e tinted glass.

The rough frame area is generally entered in the table and adjusted by the net area factor. If the net glazing area is entered instead, then the net area factor is 1.00.

Table M gives the shade factor for overhangs. The overhang shade factor depends on the orientation of the window and the projection factor. The projection factor is the overhang projection divided by the distance from the bottom of the window to the bottom of the overhang, as illustrated below.

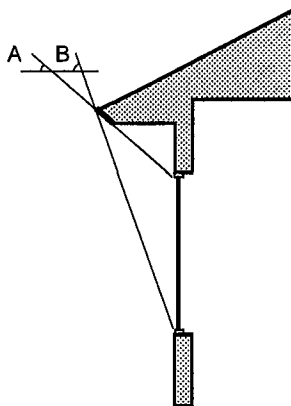

**Overhang Projection Factor**

*The projection factor is the overhang projection divided by the distance between the bottom of the window and the bottom of the overhang.*

The north windows have a height of four feet and the bottom of the overhang is about six inches above the window head. The overhang projection is 1.5 feet. The projection factor is calculated by dividing the overhang projection by the distance from the bottom of the window to the bottom of the overhang. This is about 0.33. A shade factor of 0.84 is used in the calculations, which is interpolated between the values for a projection factor of 0.2 and 0.4

If the example building had tinted glazing, glazing films or external shading devices, the shade factors from Table M should not be used. Sunscreen and glass manufacturers usually rate the shading effect of their devices by publishing a shading coefficient. The shading coefficient is a number between zero and one that indicates how much solar heat makes it through the window compared to an unshaded 1/8 inch clear pane. This shading coefficient may be used in the calculation instead of the value from Table M.

The overhang on the east and west is at the eave, well above the window, and does not provide any useful shading. For these windows, the shade factor is 1.00.

Each glazing area is multiplied by the net area factor and the appropriate shade factor. The products are summed at the bottom of the table.

**Step C. Solar Glazing**

The solar systems addressed on Worksheet II reduce heating energy, but they also can increase cooling energy. The cooling energy impact of the solar systems is calculated in this step. Each solar system listed on Worksheet II should be carried over to this worksheet. The cooling energy for each system is calculated by multiplying the total surface area (not the projected area) times the net area factor, the appropriate shade factor (as discussed above) and a heat gain factor (from Table L). This calculation gives the annual cooling load for each passive solar system.

A shade factor of 0.83 is used because of south overhangs. This is based on a projection factor of about 0.2 as discussed above.

The annual cooling load associated with all the passive solar systems is summed at the bottom of the table.



**Step D. Internal Gains**

The last component of cooling load is from internal gain. Internal gain is heat given off by lights, appliances and people. Some of the cooling load associated with internal gain is considered to be constant for all houses regardless of the number of bedrooms or size. This is because all houses have a refrigerator and at least one occupant. Another component of cooling load from internal gain is considered to be variable and depends on the number of bedrooms. These components are accounted for separately in the calculation.

Both the constant component and the variable component are taken from Table N. The variable component is multiplied by the number of bedrooms in the house and added to the constant component to yield the total cooling load from internal gain.

Constant Component	2,250	kBtu/yr
Variable Component	940	kBtu/yr-BR

**Step E. Cooling Load per Square Foot**

This step sums the cooling load associated with opaque surfaces, non-solar glazing, passive solar systems and internal gain (Steps A, B, C and D). The sum is then divided by the floor area of the building and multiplied by 1,000 to convert the cooling energy into terms consistent with the base case cooling performance.

**Step F. Adjustment for Thermal Mass and Ventilation**

The total cooling load calculated in Step E is adjusted in this step to account for the effects of thermal mass and ventilation.

The adjustment depends on the total heat capacity per square foot calculated on Worksheet III, Step E, but also depends on whether or not the building has night ventilation or ceiling fans. The adjustment is entered in the blank in Step F.

Total Heat Capacity per SF	Night		No Night	
	Vent w/ Ceil. Fan	Vent w/ No Ceil. Fan	Vent w/ Ceil. Fan	Vent w/ No Ceil. Fan
0.0	4,250	400	2,320	-1,600
1.0	5,550	1,480	3,620	-520
2.0	6,240	2,080	4,310	080
3.0	6,610	2,420	4,680	410
4.0	6,800	2,600	4,870	600
5.0	6,910	2,700	4,980	700
6.0	6,960	2,760	5,030	760
7.0	6,990	2,790	5,060	790
8.0	7,010	2,810	5,080	810
9.0	7,010	2,820	5,080	820
10.0	7,020	2,820	5,090	820

Total heat capacity per square foot is calculated on Worksheet III, Step E.

The example building has a total heat capacity per square foot of 5.6. It has neither night ventilation nor ceiling fans.

Night ventilation is a building operation strategy where windows are opened at night when the air is cooler. The cool night air allows heat to escape from the thermal mass elements in the building. The cooler thermal mass elements help keep the building comfortable the following day when air temperatures rise.

**Step G. Cooling Performance Level**

The summer cooling performance level is calculated by subtracting the adjustment in Step F from the cooling load per square foot calculated in Step E. This is an estimate of the amount of heat that must be removed from the building each year by the air conditioner.

**Step H. Comparison Cooling Performance**

The cooling performance level for the proposed design may be compared to the base case cooling performance level for the area, given in Table P.

Base Case	9,766
-----------	-------

Alternatively, the cooling performance level may be compared to other building designs considered by the builder to be typical of the area. In this case, the worksheets would first be completed for the typical design and the results of these calculations would be entered in Step H.

If the cooling performance level of the proposed building (Step G) is greater than the base case or typical-design conservation performance level, the designer should consider measures to reduce the cooling performance level. Such measures might include reducing non-solar glass, providing additional shading or increasing thermal mass.