

Solar Heating and You

The sun gives us energy in two forms: light and heat. For many years, people have been using the sun's energy to make their homes brighter and warmer.

Today, we use special equipment and specially designed homes to capture solar energy for lighting and heating.

What are solar collectors, and how do they work?

Solar collectors trap the sun's rays to produce heat. Most solar collectors are boxes, frames, or rooms that contain these parts: (1) clear covers that let in solar energy; (2) dark surfaces inside, called absorber plates, that soak up heat; (3) insulation materials to prevent heat from escaping; and (4) vents or pipes that carry the heated air or liquid from inside the collector to where it can be used.

Covers

Many clear materials can be used as *covers* for solar collectors, but glass is the most

common material. Glass can be made quickly and easily. The special glass used in solar collectors resists breaking and scratching.

When sunlight passes through glass and hits a surface inside a solar collector, it changes into heat. Although glass allows sunlight to pass through, it also traps the heat produced inside the collector.

Absorbers

The heat produced inside a solar collector is soaked up by metal sheets or containers filled with water, rocks, or bricks that have been painted black or another dark color.

A Solar Collector

vc-cd6-a0874-01

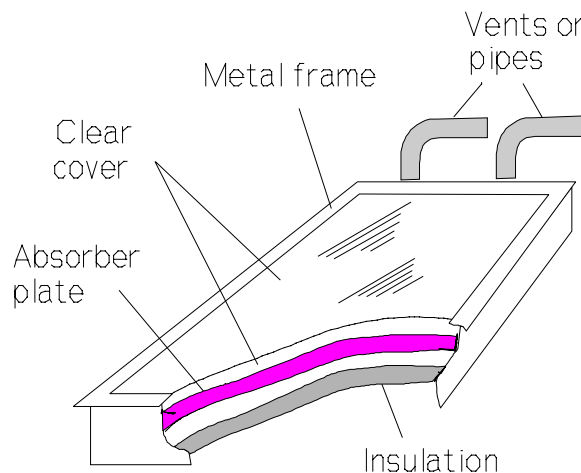

This document was produced for the U.S. Department of Energy (DOE) by the National Renewable Energy Laboratory (NREL), a DOE national laboratory. The document was produced by the Technical Information Program, under the DOE Office of Energy Efficiency and Renewable Energy. The Energy Efficiency and Renewable Energy Clearinghouse (EREC) is operated by NCI Information Systems, Inc., for NREL/DOE. The statements contained herein are based on information known to EREC and NREL at the time of printing. No recommendation or endorsement of any product or service is implied if mentioned by EREC.



Cars with dark seats are good examples of how the absorbers in solar collectors work. Did you ever sit on a dark car seat in shorts after the sun had been shining on it for a long time and the windows were closed? Ouch! When solar energy passes through the windows of a car, heat is absorbed by the seat. If the seats were a lighter color, like yellow or white, light would be reflected away from the seats, and less heat would be absorbed. Dark-colored seats absorb more heat.

These dark-colored objects that soak up heat are called *absorbers*. Without absorbers, solar heating systems would not produce enough heat to warm rooms inside your house.

Insulation

Heat always tries to move from a hotter object to a colder one. *Insulation* is what prevents or slows down the movement of heat.

Because insulation prevents the heat inside a solar collector from moving to the outside where the temperature is lower, it is an important part of any solar collector.

A Sunspace

vc-cd6-a0874-02

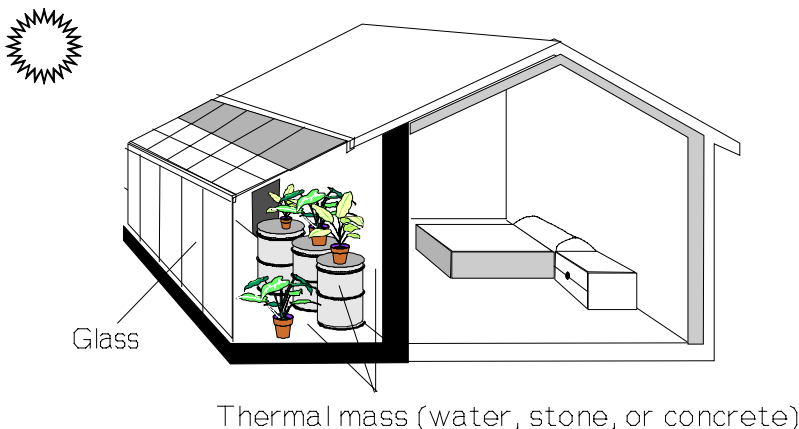

Vents and Pipes

When a solar collector is working properly, the heat that it produces moves from the collector to an area where that heat can be used. If the collector's job is to heat air, then vents, ducts (air tubes), and fans carry the heated air from the collector to another part of the house. If the collector's job is to heat water, then pipes, tubes, and pumps move water from the collector to water heating or space heating equipment.

When fans or pumps are required to move heated air or water, the heater is called an *active solar heater*. If the heated air or water from the collector moves to another part of the house naturally without fans or pumps, then the heater is called a *passive solar heater*.

Sunspaces

Solar collectors come in many shapes and sizes. A home that uses a room or another part of the building as a solar collector is called a *passive solar* home.

In many cases, passive solar homes use rooms called *sunspaces* to capture solar energy directly. A sunspace can be either a room that faces south or a small structure attached to the south side of a house.

Sunspaces have a large amount of glass and large areas of dark stone or concrete walls and

Flat-Plate Collectors

vc-cd6-a0874-03

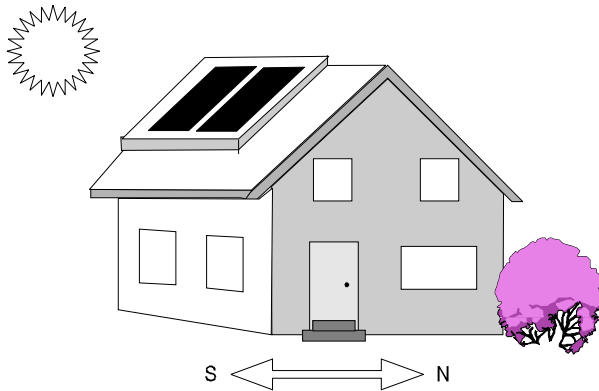

floors. These materials make up the *thermal mass*, which absorbs heat.

Vents placed against the back wall of a sunspace allow heated air to move naturally into nearby rooms. At the same time, cooler air from nearby rooms can move into the sunspaces.

Flat-Plate Collectors

Another type of solar collector is the *flat-plate collector*. Flat-plate collectors look like large, flat boxes with glass covers and dark-colored metal plates inside that absorb heat. Flat-plate collectors are usually placed on roofs of houses where no trees or tall buildings will block the sun's rays.

Air or a liquid, such as water, flows through flat-plate collectors and is warmed by the heat stored in the absorber plates. The air or water heated inside the solar collectors then

heats air or water inside the house. In an active solar air heater, a fan pushes the air heated inside the collector into a large bin full of rocks under the house. The heat is stored there so it can be used later. In an active solar water heater, the water heated inside the collector is pumped through pipes into a hot water tank.

The first flat-plate collectors were installed on the roof of a house in Los Angeles in 1909. Since then, millions of solar water and space heaters have been installed in homes and other buildings all over the world.

Active Solar Air Heater

vc-cd6-a0874-04

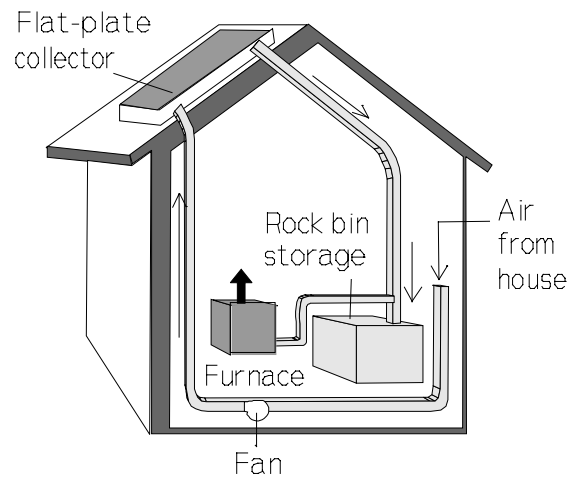

Why Use Solar Heating Systems?

Today, solar heating is becoming more important than ever before. Natural gas and oil, which are burned to heat our homes and water, are limited. As reserves of gas

Active Solar Water Heater

vc-od6-a0874-05

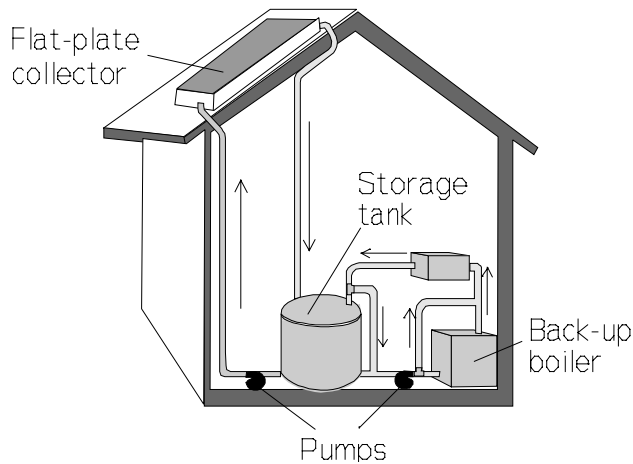

and oil shrink, these fuels become more expensive. If more people began using solar heating systems, fossil fuels such as oil and gas would become less expensive and last longer.

Burning natural gas and oil in our heating systems also causes air pollution. Even electric water and space heaters cause air pollution indirectly, because coal and natural gas are burned to produce electricity in large power plants. So if more people used solar energy to heat the air and water in their homes, our environment would be cleaner.

What Have You Learned?

1. What two forms of energy does the sun provide?
2. What are solar collectors and how do they work?

3. What parts do most solar collectors have?

4. Which car would be a better example of a solar collector?

A car that has:

- a. black seats and open windows?
- b. dark blue seats and closed windows?
- c. white seats and open windows?

5. Explain your answer to question 4.

6. What is a passive solar home?

7. Are there places in your community where you can buy solar collectors? (Look in the yellow pages section of your telephone book.)

Activity

Making a Solar Air Heater

(An adult should help you with this activity.)

Materials needed: cardboard, measuring tape, scissors, acrylic gesso paste, black acrylic paint, paint brush, thumbtacks, duct tape, thin string, plastic wrap, masking tape, thermometer, graph paper.

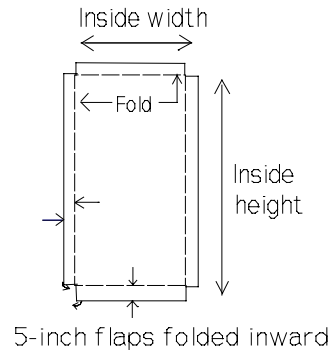
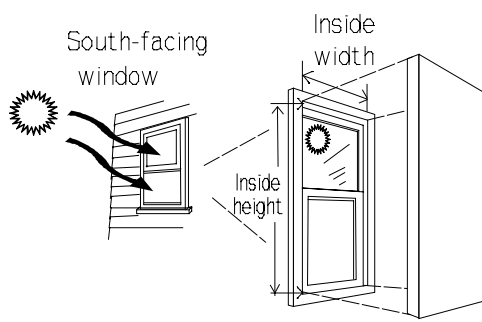

1. Find a south-facing window and measure its width and height.
2. Cut out a piece of cardboard the same height and width of the window but with four 5-inch (12.7-centimeter) flaps extending from the top, bottom, and sides.

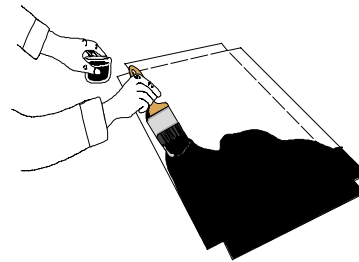
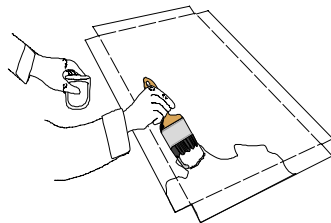

3. Apply a coat of gesso paste to one side of the cardboard. Allow the paste to dry for 10 minutes.
4. After the paste has dried, paint the same side of the cardboard with flat black acrylic paint. Allow the paint to dry.

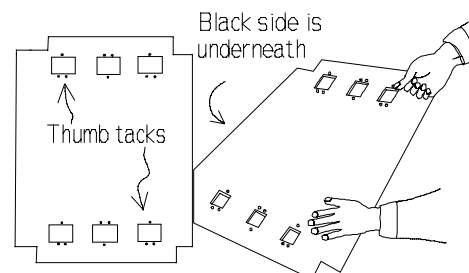
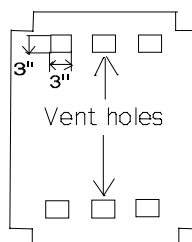

5. Cut vent holes 3-inches (7.6-centimeters) wide by 3-inches high near the top and bottom flaps of the cardboard.
6. Push thumbtacks into the cardboard around the vent holes on the inside surface.

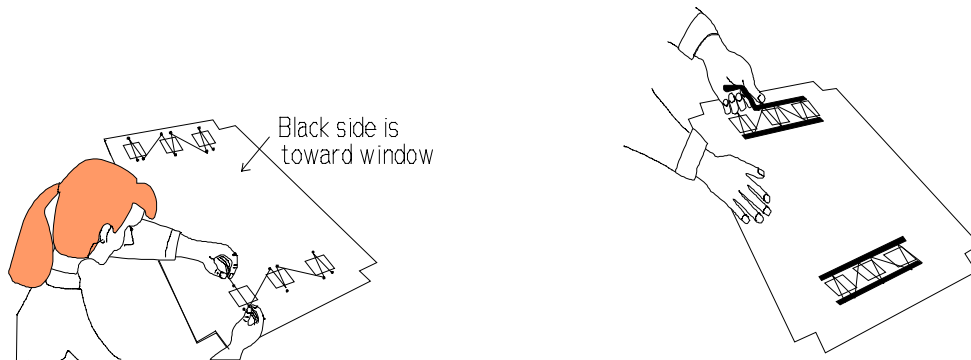

7. Weave some thin string around the thumbtacks and across the vent holes.

8. Cover the thumbtacks with thin strips of duct tape to prevent them from falling out of the cardboard.

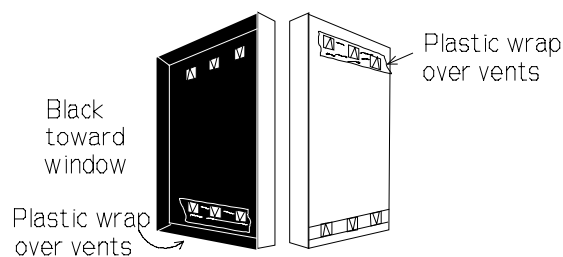

9. Cut enough plastic wrap to cover the vent holes and tape the plastic to the outside (black side) of the bottom vent holes and to the inside (string side) of the top vent holes.

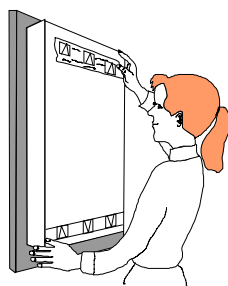

10. Slide the cardboard inside the window frame with the black side facing the window and the top vent holes up. (The plastic flaps should be hanging over the vent holes.) Tape the cardboard to the window frame with masking tape and leave an air space between the window and the cardboard.

Hint: Don't leave your collector taped to the window frame for too many days, or the tape may pull paint off when you remove it.

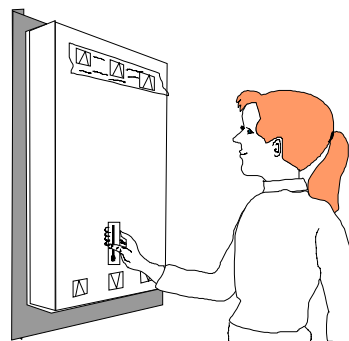
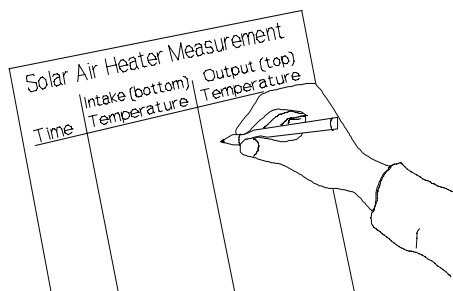

11. On the graph paper, draw lines marking three columns, and write the words "Time," "Intake (bottom) temperature," and "Output (top) temperature" at the top of the columns.
12. Once every hour for a few hours on a cloudy day, and for a few hours on a sunny day, hold the thermometer under the plastic flaps covering the vent holes for 2 minutes to measure the collector's air intake (bottom) and output (top) temperatures. Mark your temperature readings on the graph paper.
13. Did your solar collector work? During what time of the day was the collector's output temperature the highest? What was the highest output temperature of the collector on a cloudy day? On a sunny day?

Glossary

Absorbers: dark-colored objects that soak up heat in solar collectors.

Active solar heater: a solar water or space heating system that moves heated air or water using pumps or fans.

Covers: clear materials that allow sunlight to pass into solar collectors and trap heat inside the collectors.

Flat-plate collector: large, flat boxes with glass covers and dark-colored metal plates inside that absorb heat.

Insulation: materials that prevent or slow down the movement of heat.

Passive solar heater: a solar water or space heating system that moves heated air or water without using pumps or fans.

Passive solar home: a house that uses a room or another part of the building as a solar collector.

Pipes: tubes that carry heated water from solar collectors to hot water tanks.

Solar collectors: boxes, frames, or rooms that trap the sun's rays to produce heat.

Sunspace: a room that faces south, or a small structure attached to the south side of a house.

Thermal mass: materials that store heat within a sunspace or solar collector.

Vents: tubes that carry heated air from solar collectors to other parts of a house.

Resources

Energy Activities for the Primary Classroom, California Energy Extension Service, Governor's Office of Planning and Research, 1400 Tenth Street, Sacramento, CA 95814; (916) 323-4388.

The Universal House: Energy, Shelter, and the California Indian: Activity Guide, 4th/5th Grade, California Energy Extension Service, Governor's Office of Planning and Research, 1400 Tenth Street, Sacramento, CA 95814; (916) 323-4388; Fall 1992.

Science Projects in Renewable Energy and Energy Efficiency, published by the American Solar Energy Society, distributed by the National Energy Foundation, 5160 Wiley Post Way, Suite 200, Salt Lake City, UT 84116; (801) 539-1406; 1991.

Teach With Energy! Fundamental Energy, Electricity, and Science Lessons for Grades K-3, National Energy Foundation, 5160 Wiley Post Way, Suite 200, Salt Lake City, UT 84116; (801) 539-1406; 1990.

Teach With Energy! Fundamental Energy, Electricity, and Science Lessons for Grades 4-6, National Energy Foundation, 5160 Wiley Post Way, Suite 200, Salt Lake City, UT 84116; (801) 539-1406; 1992.

The Solar Home Book: Heating, Cooling, and Designing with the Sun, by Bruce Anderson with Michael Riordan, Brick House Publishing Company, ISBN: 0-917352-01-7; 1976.

A Golden Thread: 2500 Years of Solar Architecture and Technology, by Ken Butti and John Perlin, Van Nostrand Reinhold Company, ISBN: 0-442-24005-8; 1980.

Renewable Energy Fact Sheets, Solar Energy Industries Association, 122 C Street, NW, 4th Floor, Washington, DC 20001-2109; (202) 383-2600.

Experimenting with Energy, by Alan Ward, Chelsea House, ISBN: 0-7910-1510-6; 1991.

Renewable Energy: A Concise Guide to Green Alternatives, by Jennifer Carless, Walker & Company, ISBN: 0-8027-8214-0.

Renewable Energy, by Alan Collison, Raintree Steck-Vaughn, ISBN: 0-8114-2802-8; 1991.