



# Soaking up Energy Savings from Water Projects



NREL ESIF Data  
Center Water Use  
Reductions



# Soaking up Energy Savings from Water Projects

## NREL ESIF Data Center Water Use Reductions

Otto Van Geet, PE – NREL

July 10, 2019

NREL/PR-7A40-74145

# NREL Data Center Design

## ■ Showcase Facility

- ESIF 182,000 ft.<sup>2</sup> research facility
- 10,000 ft.<sup>2</sup> data center
- 10 MW at full buildout
- LEED Platinum facility, PUE ≤ 1.06
- No mechanical cooling (eliminates expensive and inefficient chillers)



*Utilize the bytes and the BTUs!*

## ■ Data Center Features

- Direct, component-level liquid cooling, 24°C (75°F) cooling water supply
- 35-40°C (95-104°F) return water (waste heat), captured and used to heat offices and lab space
- Pumps more efficient than fans
- High voltage 480 VAC power distribution directly to high power density 60-80 kW compute racks

## ■ Compared to a Typical Data Center

- Lower CapEx—costs less to build
- Lower OpEx—efficiencies save

*Integrated “Chips to Bricks” Approach*

# Metrics

$$PUE = \frac{\text{“Facility energy”} + \text{“IT energy”}}{\text{“IT energy”}}$$

$$ERE = \frac{\text{“Facility energy”} + \text{“IT energy”} - \text{“Reuse energy”}}{\text{“IT energy”}}$$

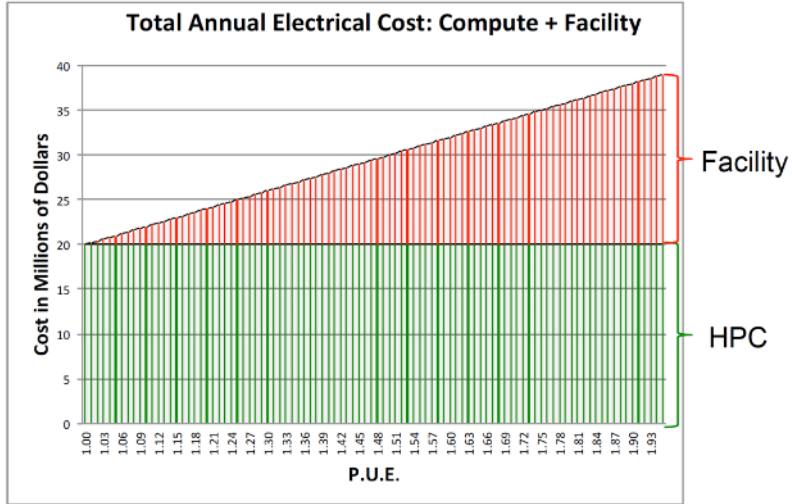

Assume ~20MW HPC system & \$1M per MW year utility cost.

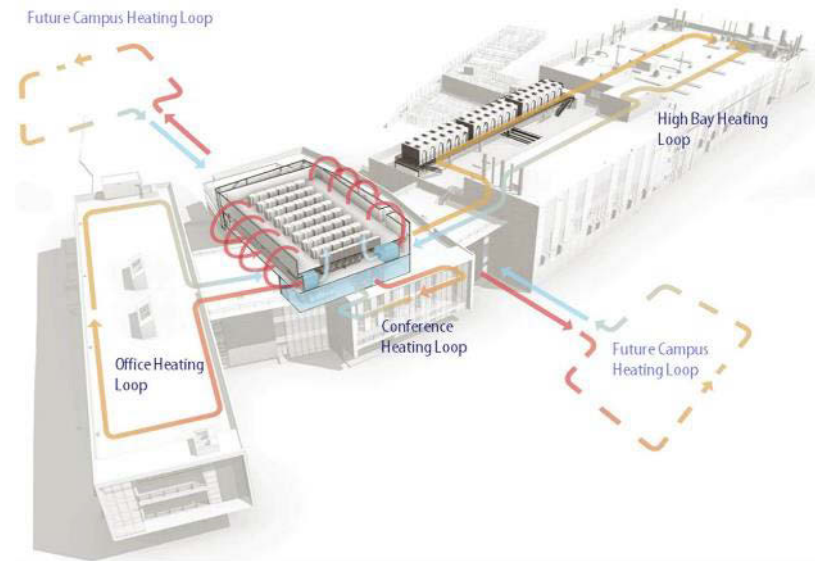

# Metrics

$$WUE = \frac{\text{“Annual Site Water Usage”}}{\text{“IT energy”}}$$

the units of WUE are liters/kWh

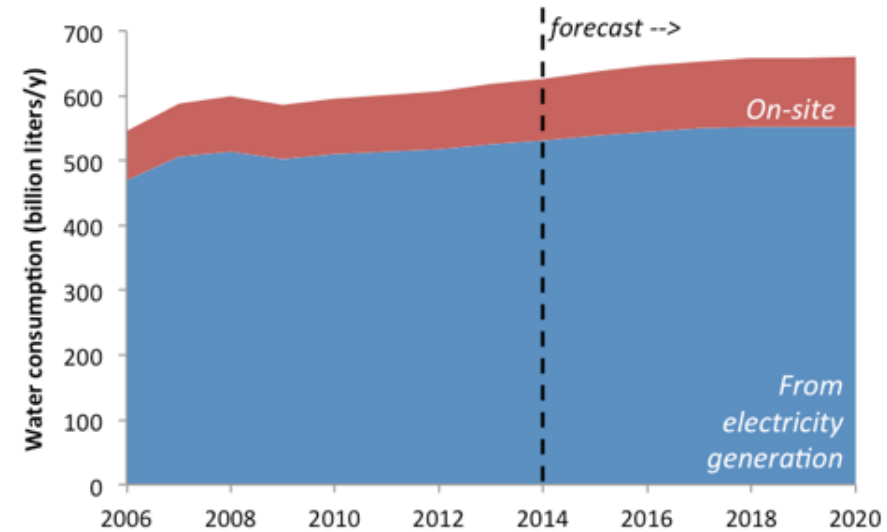

$$WUE_{SOURCE} = \frac{\text{“Annual Site Water Usage”} + \text{“Annual Source Energy Water Usage”}}{\text{“IT energy”}}$$

$$WUE_{SOURCE} = \frac{\text{“Annual Site Water Usage”}}{\text{“IT energy”}} + [EWIF \times PUE]$$

where EWIF is energy water intensity factor

# Air- and Water-Cooled System Options

## ■ Air-Cooled System

- Operation is based on DRY BULB temperature
- Consumes no water (no evaporative cooling)
- Large footprint requires very large airflow rates

## ■ Water-Cooled System

- Operation is based on the lower WET BULB temperature
- Evaporative cooling process uses water to improve cooling efficiency
  - 80% LESS AIRFLOW = lower fan energy
  - Lower cost and smaller footprint
- Colder heat rejection temperatures improve system efficiency

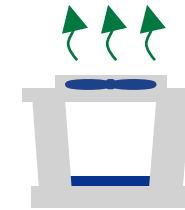
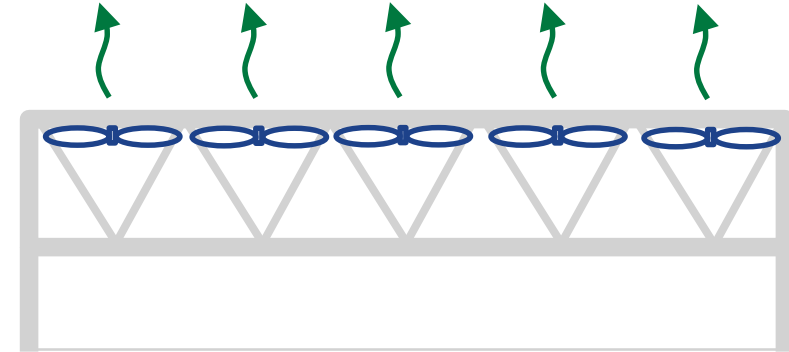

*However, water-cooled systems depend on a reliable, continuous source of water.*

# Traditional Wet Cooling System

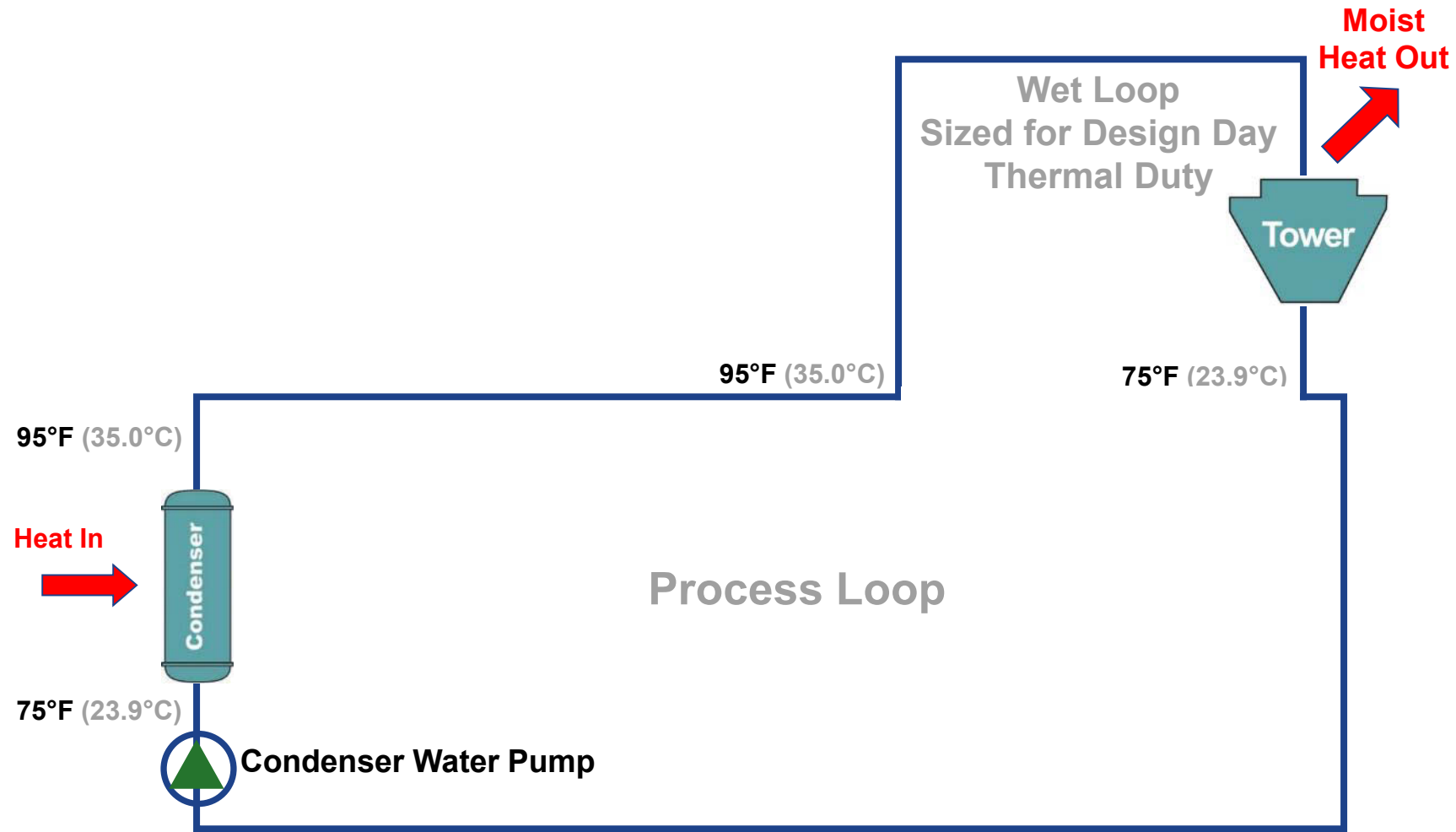

# Basic Hybrid System Concept

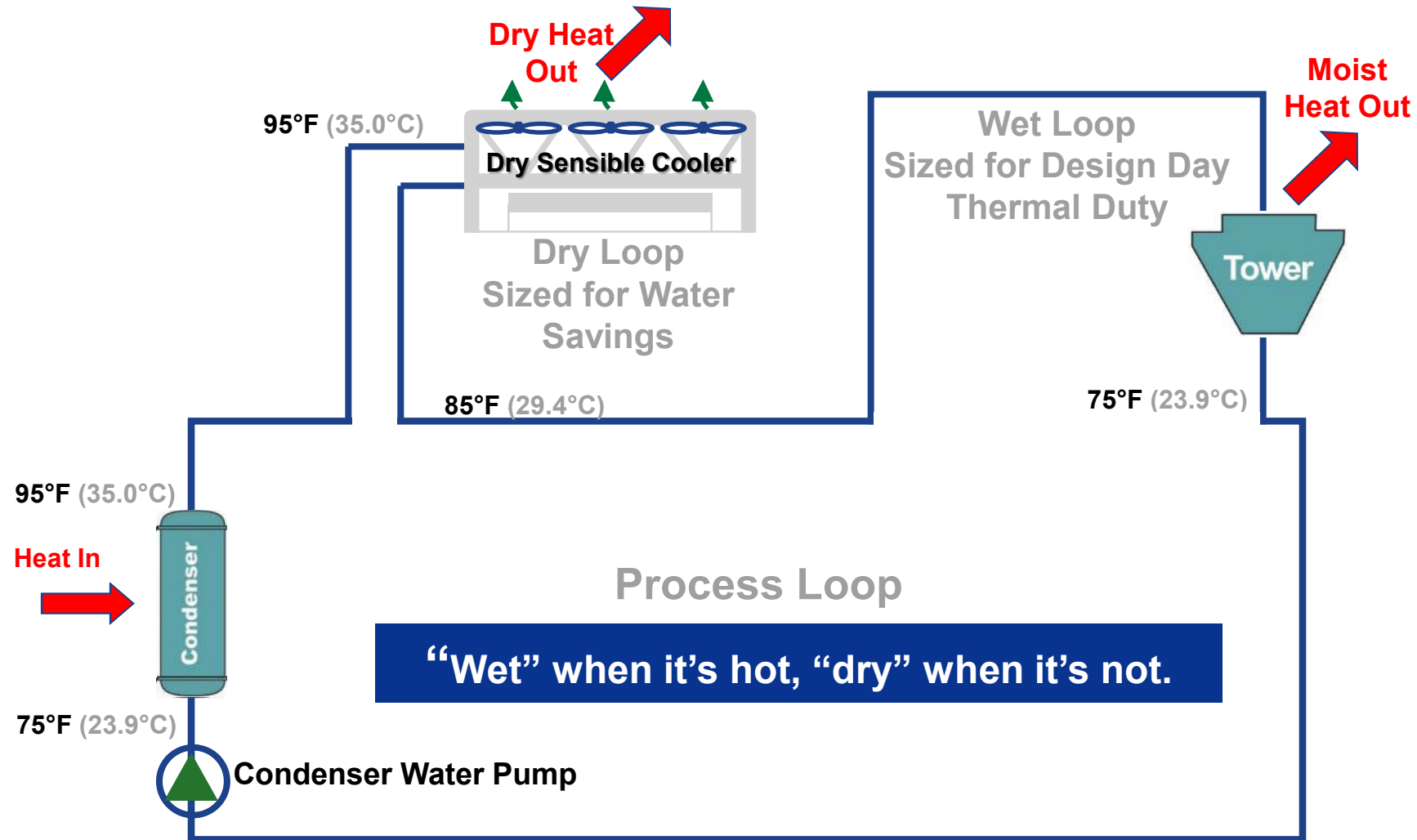



# Improved WUE—Thermosyphon

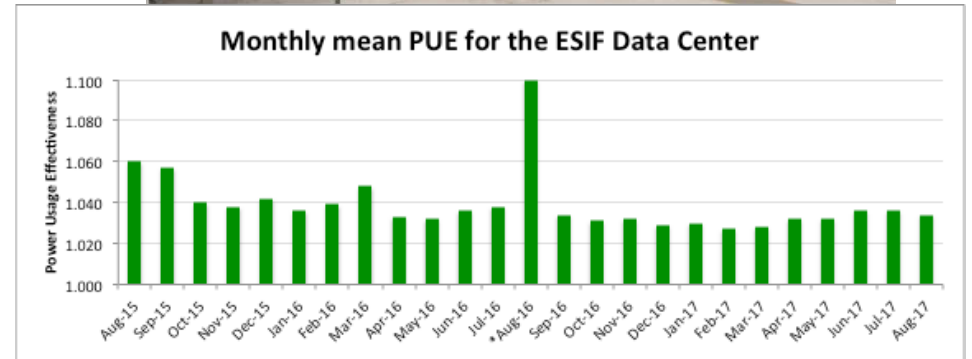
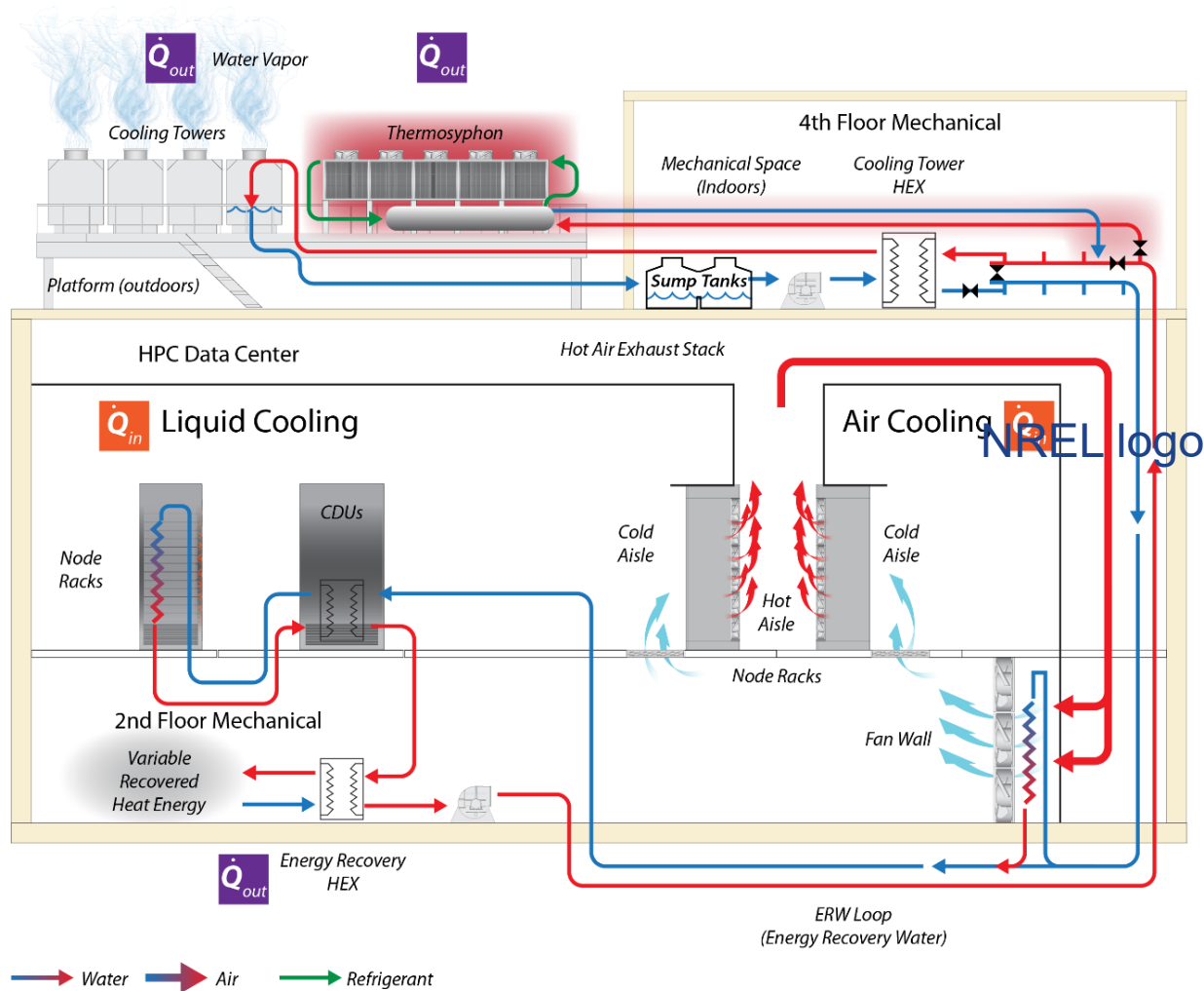

Any application using an open cooling tower is a potential application for a hybrid cooling system, but certain characteristics will increase the potential for success.

## ■ Favorable Application Characteristics

- Year-round heat rejection load (24/7, 365 days is best)
- Higher loop temperatures relative to average ambient temperatures
- High water and wastewater rates or actual water restrictions
- Owner's desire to mitigate risk of future lack of continuous water availability (water resiliency)
- Owner's desire to reduce water footprint to meet water conservation targets

# Sample Data: Typical Loads and Heat Sinks

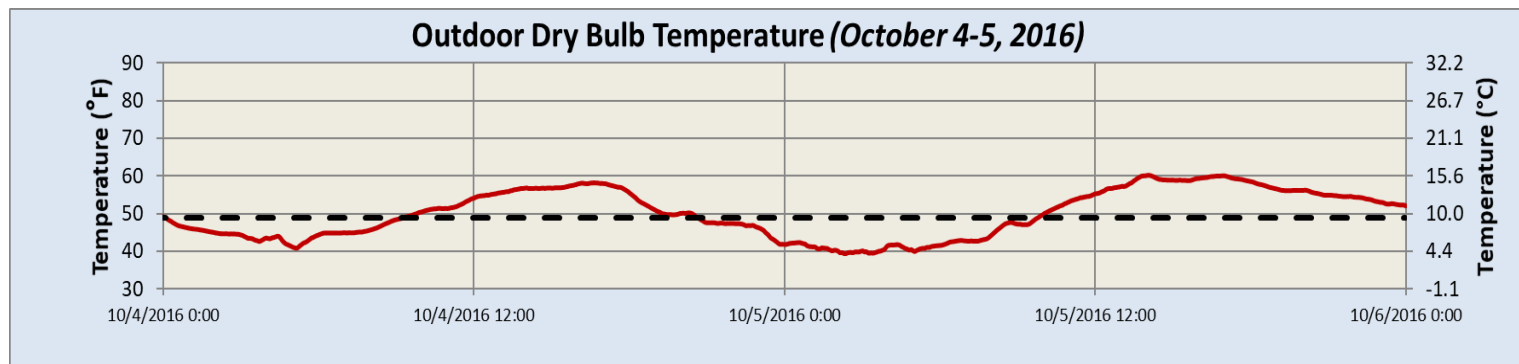
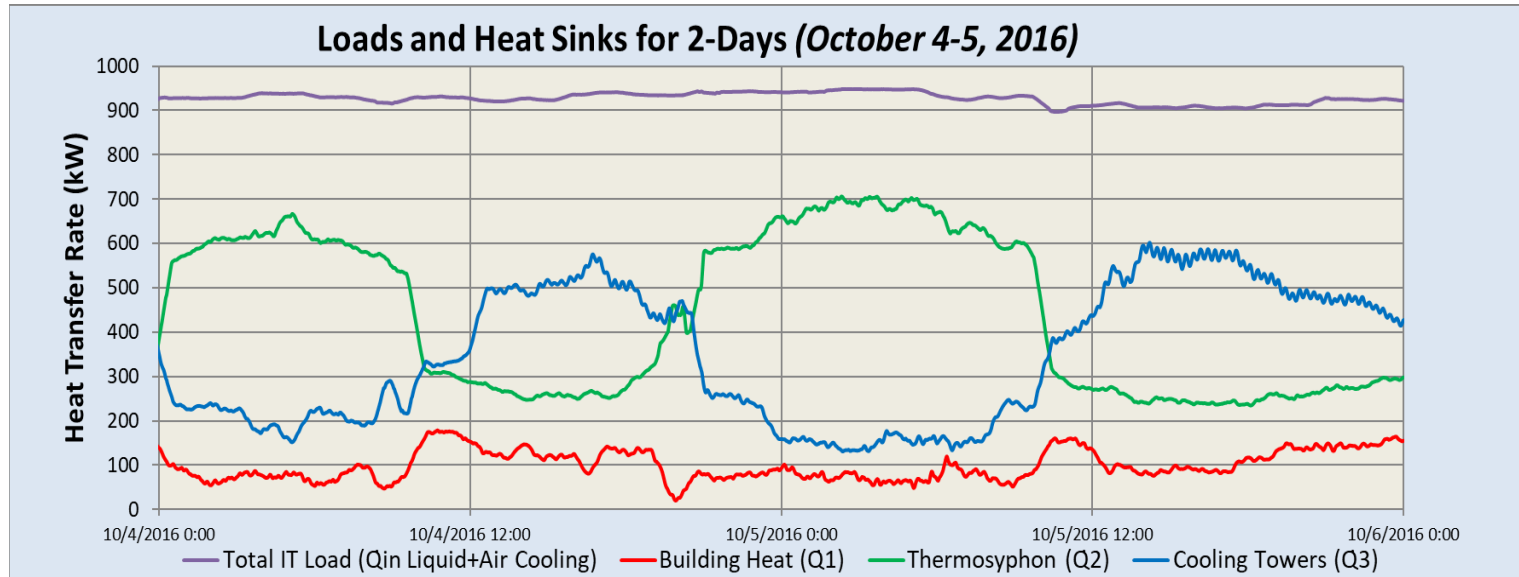

# Data Center Metrics

## First Year of TSC Operation (9/1/16 - 8/31/17)

Hourly average IT Load = 888 kW

PUE = 1.034

ERE = 0.929

WUE = 0.7 liters/kWh

with only cooling towers, WUE = 1.42 liters/kWh

### Annual Heat Rejection

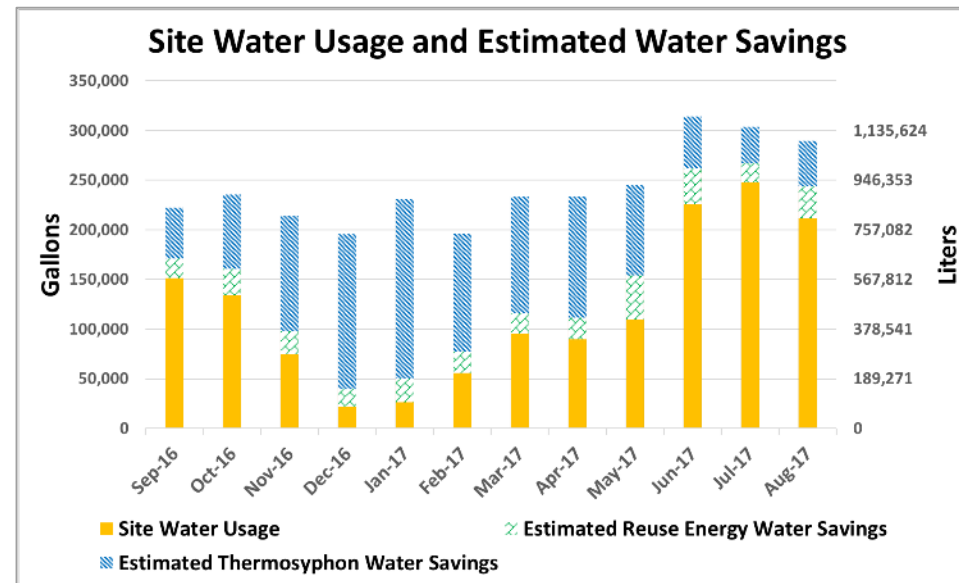
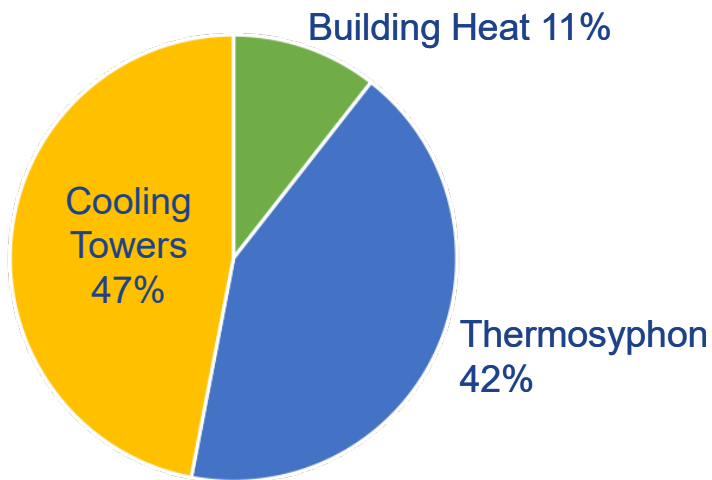

$WUE_{SOURCE} = 5.4$  liters/kWh

$WUE_{SOURCE} = 4.9$  liters/kWh if energy from 720 kW PV (10.5%) is included

using EWIF 4.542 liters/kWh for Colorado

# Cost and Water Savings

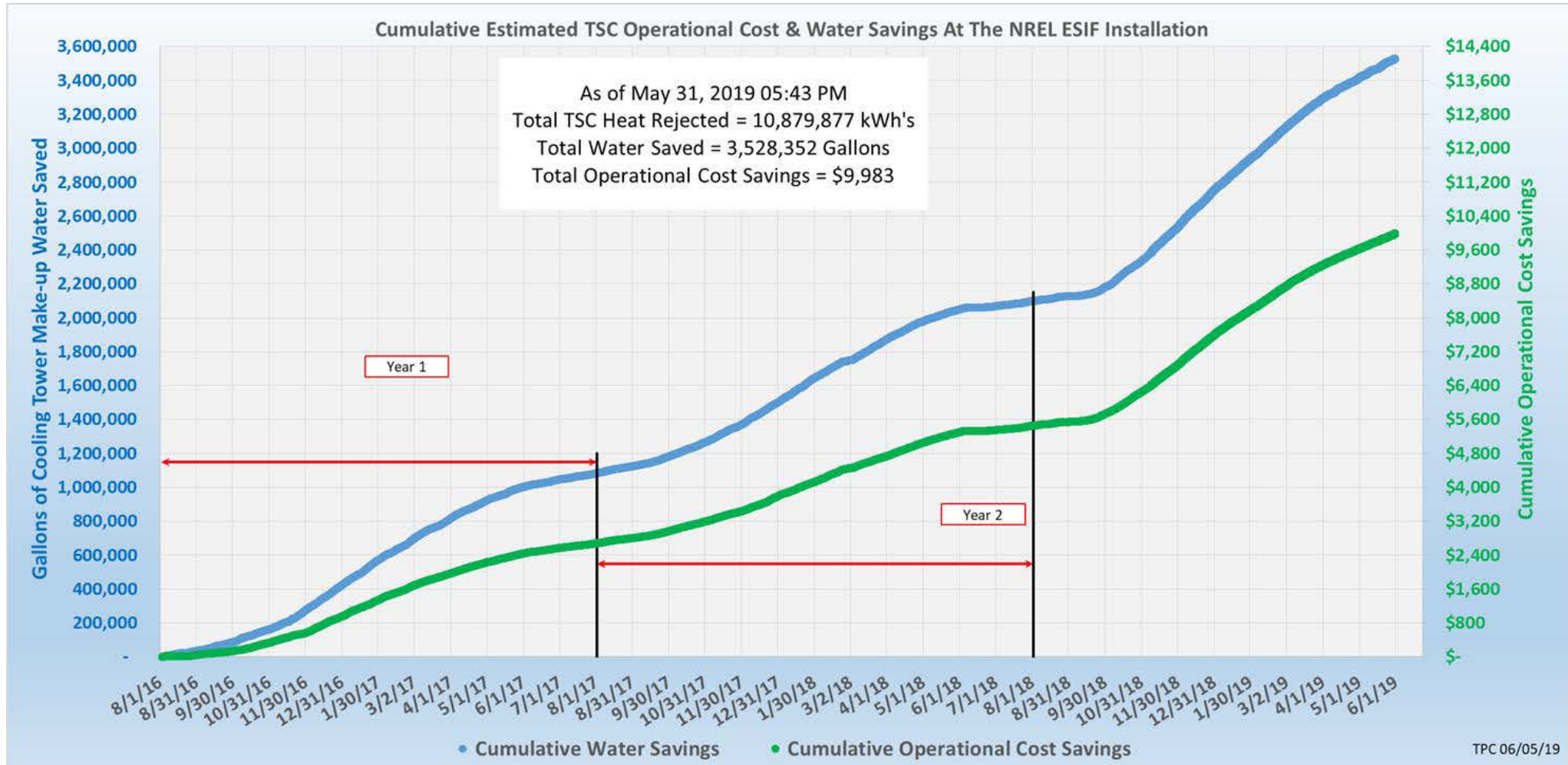

# Questions?



# Notice

This research was performed using computational resources sponsored by the U.S. Department of Energy's (DOE) Office of Energy Efficiency and Renewable Energy and located at the National Renewable Energy Laboratory under Contract No. DE-AC36-08GO28308. Funding provided by the Federal Energy Management Program. The views expressed in the presentation do not necessarily represent the views of the DOE or the U.S. Government. The U.S. Government retains and the publisher, by accepting the presentation for publication, acknowledges that the U.S. Government retains a nonexclusive, paid-up, irrevocable, worldwide license to publish or reproduce the published form of this work, or allow others to do so, for U.S. Government purposes.