



Integration Issues of Cells into Battery Packs for Plug-In and Hybrid Electric Vehicles

Preprint

A.A. Pesaran, G.-H. Kim, and M. Keyser

*Presented at EVS-24 International Battery, Hybrid and Fuel Cell Electric Vehicle Symposium
Stavanger, Norway
May 13-16, 2009*

Conference Paper
NREL/CP-540-45779
May 2009

NREL is operated for DOE by the Alliance for Sustainable Energy, LLC

Contract No. DE-AC36-08-GO28308



NOTICE

The submitted manuscript has been offered by an employee of the Alliance for Sustainable Energy, LLC (ASE), a contractor of the US Government under Contract No. DE-AC36-08-GO28308. Accordingly, the US Government and ASE retain a nonexclusive royalty-free license to publish or reproduce the published form of this contribution, or allow others to do so, for US Government purposes.

This report was prepared as an account of work sponsored by an agency of the United States government. Neither the United States government nor any agency thereof, nor any of their employees, makes any warranty, express or implied, or assumes any legal liability or responsibility for the accuracy, completeness, or usefulness of any information, apparatus, product, or process disclosed, or represents that its use would not infringe privately owned rights. Reference herein to any specific commercial product, process, or service by trade name, trademark, manufacturer, or otherwise does not necessarily constitute or imply its endorsement, recommendation, or favoring by the United States government or any agency thereof. The views and opinions of authors expressed herein do not necessarily state or reflect those of the United States government or any agency thereof.

Available electronically at <http://www.osti.gov/bridge>

Available for a processing fee to U.S. Department of Energy and its contractors, in paper, from:

U.S. Department of Energy
Office of Scientific and Technical Information
P.O. Box 62
Oak Ridge, TN 37831-0062
phone: 865.576.8401
fax: 865.576.5728
email: <mailto:reports@adonis.osti.gov>

Available for sale to the public, in paper, from:

U.S. Department of Commerce
National Technical Information Service
5285 Port Royal Road
Springfield, VA 22161
phone: 800.553.6847
fax: 703.605.6900
email: orders@ntis.fedworld.gov
online ordering: <http://www.ntis.gov/ordering.htm>



EVS24
Stavanger, Norway, May 13-16, 2009

Integration Issues of Cells into Battery Packs for Plug-in and Hybrid Electric Vehicles

Ahmad A. Pesaran¹, Gi-Heon Kim, and Matt Keyser

*National Renewable Energy Laboratory
1617 Cole Blvd, Golden, CO 80401 USA*

¹Tel: +1 303 275-4441; Fax: +1 303 275-4415; Email: ahmad_pesaran@nrel.gov

Abstract

The main barriers to increased market share of hybrid electric vehicles (HEVs) and commercialization of plug-in HEVs are the cost, safety, and life of lithium ion batteries. Significant effort is being directed to address these issues for lithium ion cells. However, even the best cells may not perform as well when integrated into packs for vehicles because of the environment in which vehicles operate. In this paper, we discuss mechanical, electrical, and thermal integration issues and vehicle interface issues that could impact the cost, life, and safety of the system. We compare the advantages and disadvantages of using many small cells versus a few large cells and using prismatic cells versus cylindrical cells.

Keywords: Lithium battery, battery management, cooling, electric drive, modelling, thermal management

1 Introduction

Hybrid electric vehicles (HEVs) and plug-in hybrid electric vehicles (PHEVs) have the potential to reduce a significant amount of petroleum used for transportation in the next 10-20 years. The major obstacle to increasing the market share of HEVs and to the mass production of commercial PHEVs is the battery. Batteries for these vehicles must be high-performing, inexpensive, long-lasting, and safe. Lithium ion batteries have the potential to meet those challenges. A significant amount of R&D is being performed around the world to improve the attributes of the cells. However, poorly integrating even good cells in modules and packs may lead to lower performance, life, and safety and increased cost. Integration must address mechanical, packaging, electrical, thermal, safety, monitoring and control and interface with the rest of the vehicle. In the case of PHEVs,

packs need to be interfaced with an on-board charger obtaining electricity from an alternating current grid. In the terminology used here, which is widely used by battery developers (Figure 1), a “cell” consists of the electrochemical unit with the lowest voltage of the associated chemistry. A module consists of several cells to produce mid-range voltage, up to 50 V, and a pack consists of many modules (or cells). The pack is housed in a container with electronic and thermal control that creates the total system that interfaces with the rest of the vehicle components. Each module or pack has its appropriate packaging, mechanical, electrical, and thermal controls. In the initial design of a battery pack, one must consider the following: safety (abuse tolerance), cost of packaging for the whole system, impact packaging and control on life and durability, packaging for recyclability and reuse, manufacturability for lower cost, maintenance/repair considerations, thermal management (since temperature impacts life and performance), electronics for monitoring

and control, and gauges that show the capacity, power, and degradation rate. Battery pack integration must be achieved while meeting multiple requirements and balancing multiple inputs and outputs [1]. In this paper, we will explore the use of small versus large cells and prismatic/laminate versus cylindrical cells. Battery modelling design tools will be discussed.

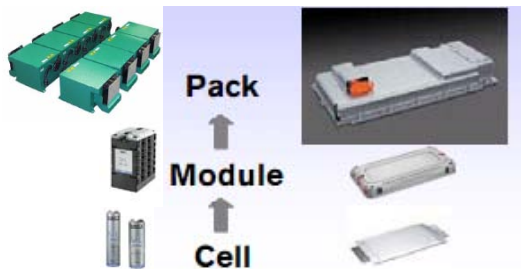

Figure 1: Cell, module, and pack

2 Battery Integration

Figure 2 shows how the battery pack or the energy storage system (ESS) integration could impact or influence other parameters or components.

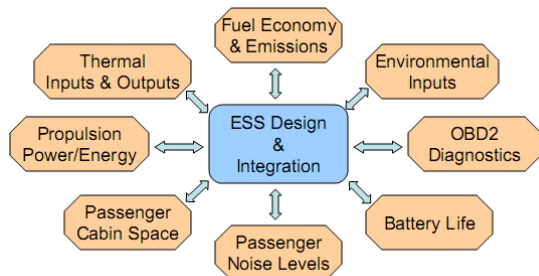

Figure 2: Components in battery pack integration and interface with vehicle, adapted from [1]

Mechanical elements and packaging should consider how cell-to-cell interconnects are designed; the particular cell, module, and electronic assembly; the structural protection points for shock and vibration; how the pack is crush-protected; the desired attachment points to the vehicle; and the mechanical interfaces with other components [2]. Electrical management includes the interfaces with the vehicle so that the DC power can go back and forth from the battery to the inverter or motor controller; how voltage, current (pressure), and temperature are measured and monitored; and how the state of

charge (SOC), capacity, available energy, power capability, state of health, impedance, and rate of degradation are measured. Electrical safety also has to be considered by the appropriate use of fuses and automatic interconnects. Thermal management is a must, because, as the battery is used and power goes in and out, the inefficiency of the battery, even if it is less than 5%-10%, could lead to heating of the cells (sometimes not uniformly), and high temperatures could lead to lower life and reduced vehicle fuel economy.

2.1 Battery Safety

Safety is another big concern for lithium ion battery packs. During abuse tests, many have observed that overvoltage, overdischarge, overcharge, heating, arcing, crush, nail penetration, external short, and internal short due to defects could lead to thermal runaway and electrolyte leaks, smoke, venting, fire, and even explosion [4]. Although many of the electrical and mechanical controls could almost eliminate or significantly reduce the probability of these events, such as overvoltage and crush, thermal runaway due to internal short because of native contamination is still a concern. It is estimated that today's 18650 Li ion cells (produced in high quantities for computers and other electronics) have an internal short failure rate of 1 in 5-10 million. We estimate that each battery pack for future (P)HEVs may have between 100 and 200 larger cells, and of course much larger ampere-hour (Ah) capacity for PHEVs. Although the battery packs in HEVs and PHEVs use much larger cells, and their production quality is not yet established, one can assume the same failure rate of 18650 cells for larger cells. This means that roughly 1 cell in roughly 50,000 packs may have an internal short leading to a safety event. This is too high. The pack could be designed in such a way that, as a cell goes to thermal runaway, design features could prevent propagation from cell to cell, eventually reducing the pack safety events to 1 in 1 million or more.

2.2 A Few Large Cells vs. Many Small Cells

Another integration issue that has to be considered is using many small cells versus using fewer larger cells for PHEV and EV applications. For example, EnergyCS uses more than 2000 small 18650 cells (2 Ah) for their PHEV pack conversion. Chrysler uses 200 much larger cells (41 Ah) for its PHEV

conversion pack. Using many small cells has advantages, including lower cell cost (commodity market), improved safety (faster heat rejection), the small magnitude of safety events because of the smaller cell, and higher quality production. However, disadvantages include many interconnects, much higher integration and assembly costs, lower weight and volume efficiency, lower reliability (many components, but some redundancy), and costly electrical management. Using fewer large cells has advantages that include lower assembly cost, higher weight and volume efficiency, and higher reliability (a lower number of components). However, the disadvantages include higher cell cost, lower quality, more difficult thermal management, and the large magnitude of safety events. The final decision about which system to use must depend on a trade-off analysis for specific application. A comparison of thermal performance is given in Section 4.

2.3 Cylindrical vs. Prismatic Cells

Another item to be considered for integration is the use of cylindrical cells versus prismatic (or laminate) cells. Cylindrical cells can be produced in high volumes and with high quality. But as the need for various shape-factors changes, the cost advantages may be less. Cylindrical design is robust and structurally strong, particularly for handling, shock, and vibration, and it has the ability to maintain pressure and venting to prevent safety events. As their size gets larger, the ratio of their external surface area to volume decreases; thus, heat transfer ability goes down and the internal temperature gradient can increase. The prismatic or laminate design could have a higher heat transfer surface area to volume ratio and could be thermally managed easier. Prismatic cells could be packaged with better volume efficiency than cylindrical cells. However, if soft pouch packaging is used, attention must be paid to preventing local stresses. Handling, shock, and vibration must be considered in the design. These could add volume and weight and could reduce the volumetric advantage of pouch prismatic cells. A comparison of thermal performance is given in Section 4.

3 Battery Management System

3.1 Battery Electrical Control System

The battery management system for a battery pack is used to monitor and control the voltage differences between cells and the temperature of individual cells within the pack. The battery management system ensures that the cells are not allowed to exceed the manufacturer's specified voltage and temperature for the battery system. In order for the cells to remain balanced during and after cycling, a balancing circuit is required. Most balancing circuits consist of a buck-boost circuit or a buck/resistive balancing circuit. The balancing resistors for large capacity cells may need to be larger in order to handle the voltage differences between cells during HEV and PHEV cycling – more energy may be wasted to bring the cells into balance. Furthermore, a cooling circuit may be required for the balancing board. Also, when smaller cells are placed in parallel to increase the capacity of the pack, the voltage of the parallel string is monitored as compared to the voltage of each individual cell. By monitoring the parallel string of cells, the failure of a single cell may be missed and may lead to a damaging situation. Figure 3 shows an example of electrical components in a battery management system.

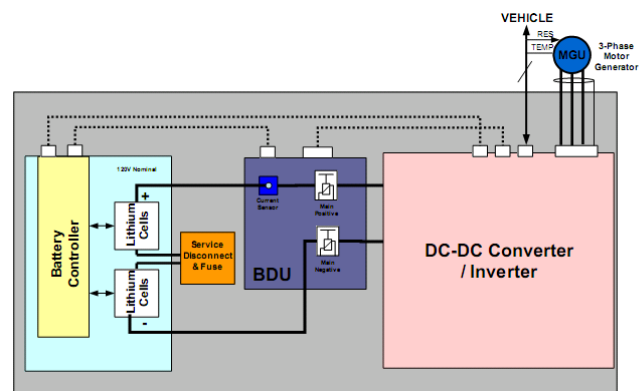

Figure 3: Electrical components of a battery pack, from [3]

3.2 Battery Thermal Control

Thermal management of batteries is critical in achieving the desired performance in a low-temperature environment and the desired life in the high-temperature environment. High temperatures degrade the life of the Li ion batteries, while cold temperatures reduce power and energy capabilities, thus limiting their driving range or performance capabilities. A thermal management system is

thus needed to either heat the batteries in cold temperatures or cool them in high temperatures. Either of these cooling and heating systems adds cost, weight, and volume to the battery pack. Electrochemistries that are more tolerant to low and high temperatures are being pursued, but it is a challenging R&D effort. To cool the batteries, air, liquid, refrigerant, or fin cooling is considered. For all of these systems, heat has to be rejected outside the vehicle. Some air cooling techniques, such as those in the Toyota Prius, pass cooled cabin air (by the vehicle's air conditioner) through the batteries. In liquid or fin cooling systems, a secondary refrigeration loop to reject the heat may be needed. In most cases, either air or liquid cooling, with the aid of a refrigeration system, is sufficient for keeping the battery temperature below damaging limits. However, depending on the location of the battery pack in the vehicle and the magnitude of cooling availability, neither air nor liquid cooling is sufficient, and a phase-change material should be used.

One important factor in thermal management is not only to maintain the maximum battery temperature below the high limits, but also to maintain uniformity of temperature between cells. It is desirable for this variation to be in a tight range (for example, less than 5°C) for improved balancing of the pack.

4 Cell Thermal Analysis

Figure 4 shows schematics of procedures for a power profile evaluation of a 20 Ah cell with the US06 driving scenario for a mid-size PHEV10 application. During the initial drive (about the first 10 minutes), the vehicle consumes electric energy stored in the on-board battery system; this is the charge-depleting (CD) drive. After that, the system maintains the state of charge of the battery and drives the vehicle in normal hybrid mode; this is the charge-sustaining (CS) drive. So, the battery is used more intensely during the initial drive.

Impacts of the size (capacity) of unit cell and form factor on the thermal response of the cell are investigated, focusing on CD drive conditions through simplified thermal analysis; electrical/electrochemical impacts of designs were not considered. (Capacity and dimensions of the compared prismatic and cylindrical cells are shown in Table 1 and Table 2.)

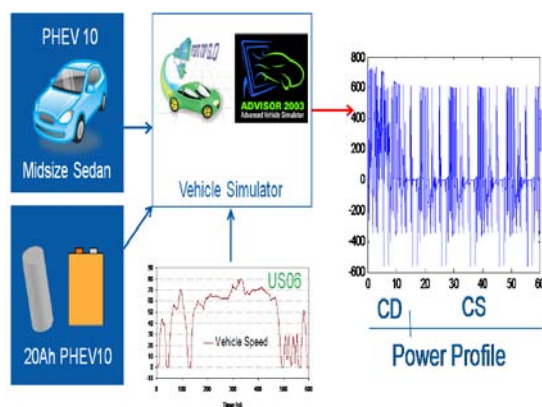

Figure 4: Schematics for 20 Ah cell power profile evaluation with PHEV10 application (120 Wh/kg cell, 78 BSF)

Table 1: Comparison of the capacity and dimension of prismatic cells

PRISMATIC	Base (AP)	Small (BP)	Thin (CP)
Capacity	1 x 20Ah	3 x 6.7Ah	1 x 20Ah
Dimension(mm)	100x140x15	100x140x5	140x200x7.5

Table 2: Comparison of the capacity and dimensions of cylindrical cells

CYLINDRICAL	Base (AC)	Small (BC)	Thin (CC)
Capacity	1 x 20Ah	3 x 6.7Ah	1 x 20Ah
Dimension(mm)	R:42.2 H:150	R:28.5 H:110	R:36.6 H:200

The heat generation rate per 20 Ah cell was calculated and is presented in Figure 5. For modelling purposes, time-averaged values were evaluated for given period of time, as shown in the graph, and applied as inputs to the following thermal simulation analysis. All external boundaries of each cell are assumed to be used for surface cooling where the convective heat transfer coefficient is fixed at 20 W/m²K for 30°C ambient temperature. Orthotropic thermal conductivities (27 W/mK in the electrode layer parallel direction and 0.8 W/mK in the layer normal direction) are applied to composite jellyroll volume.

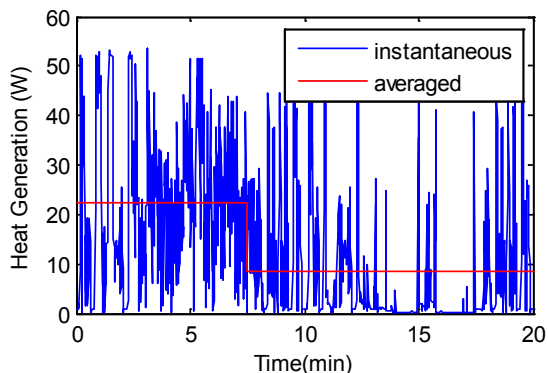

Figure 5: Instantaneous and averaged heat generation rate per cell (20 Ah)

Figure 6(a) compares average temperature rise and internal temperature variation of Cell AP and Cell BP. They are prismatic cells having the same base area (100 mm by 140 mm) but different thicknesses and capacities. As shown in the graph, constructing a battery system with multiple small cell parallel banks (Cell BP) rather than with a single large cell string in series (Cell AP) could allow for better thermal management. The large cell (AP) shows about a 15°C temperature rise with a 2°C internal temperature difference, while the small cell (BP) shows less than a 10°C temperature rise with a 1°C or less spatial temperature imbalance due to the increase in available cooling surface area and the decrease in thermal diffusion distance.

Using small cells quickly increases the complexity and the cost of the coolant flow pathway design and system assembly, however. Cell AP and Cell CP have the same capacity but a different form factor. Cell CP is thinner and has a wider base area, to have a larger cooling surface and shorter thermal diffusion length in the layer normal direction.

Making a cell thinner would help in thermal management, as seen in Figure 6(b), but a larger base area would cause severe current convergence and nonuniform material use issues where tabbing design becomes critical for cell performance and degradation. Figure 6(c) shows the importance of a material property change. When thermal conductivity in the layer normal direction decreases fourfold, the internal temperature difference increases from 2°C to 5°C for a given case.

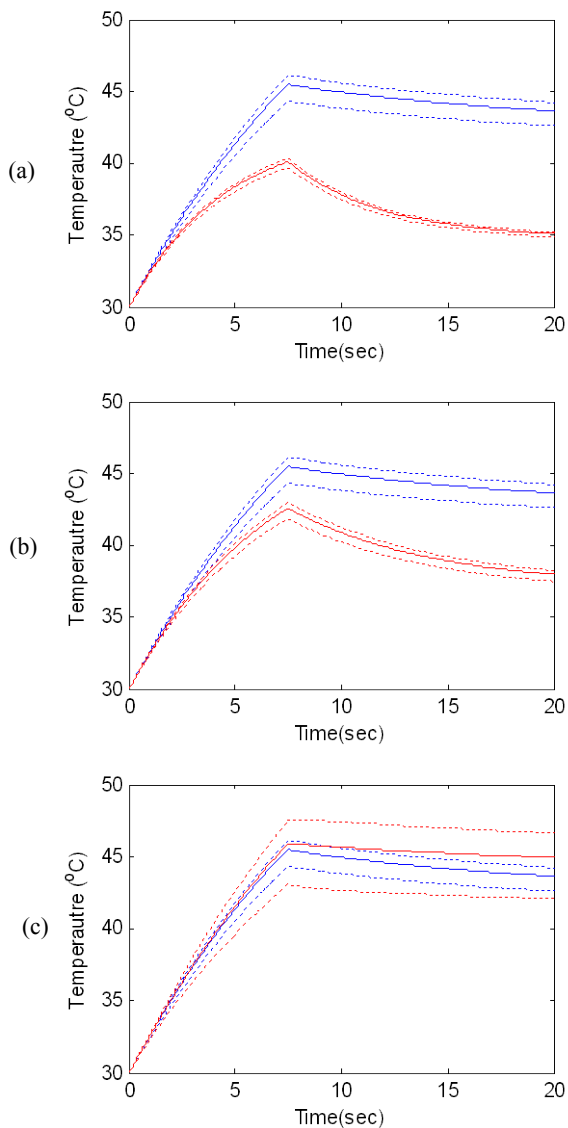

Figure 6: (a) Comparison of average temperatures (solid line) and maximum/minimum temperatures (dotted) time variation for Cell AP (blue) and Cell BP (red) with mid-size PHEV10 US06 driving scenario; (b) same for Cell AP (blue) and Cell CP (red); (c) same for Cell AP with different layer normal conductivity, 0.8 W/mK (blue) and 0.2 W/mK (red)

Thermal management is more difficult for large cylindrical format cells than it is for prismatic cells. The thermal responses of a large cylindrical cell (AC) and a small cylindrical cell (BC) are compared in Figure 7(a), and impacts of form factor are compared in Figure 7(b). In large cylindrical cell (AC), the temperature still increases during the CS drive, which implies heat rejection from the cell is slower than heat generation, even in CS mode. The temperature difference between the cell's center and its surface reaches 5°C for AC and 3°C for BC. A tall, thin cylinder would be better in thermal aspects, as seen in Figure 7(b). However, a thin cylinder could cause a longer electron current path, leading to degradations in performance and life.

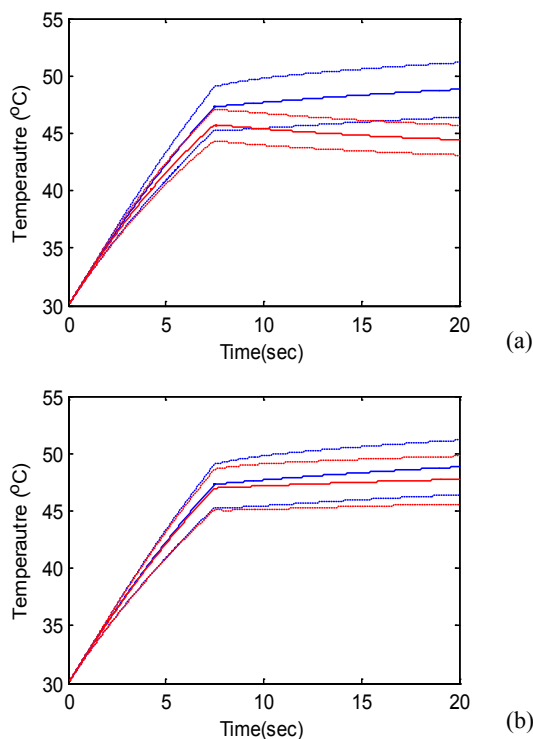

Figure 7: (a) Comparison of average temperatures (solid) and maximum/minimum temperatures (dotted) time variation for Cell AC (blue) and Cell BC (red) with mid-size PHEV10 US06 driving scenario; (b) same for Cell AC (blue) and Cell CC (red)

Figure 8 simply compares the thermal responses of nominal 20 Ah prismatic (AP) and cylindrical (AC) cells.

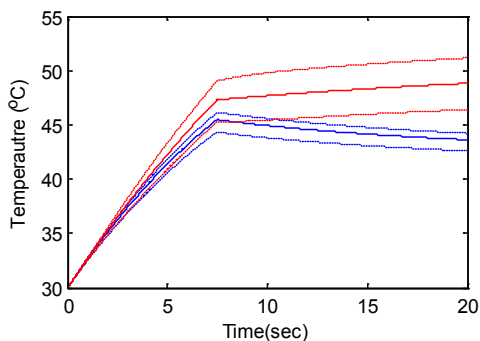

Figure 8: Comparison of average temperatures (solid) and maximum/minimum temperatures (dotted) time variation for Cell AP (blue) and Cell AC (red) with mid-size PHEV10 US06 driving scenario

5 Computer-Aided Engineering Tools

Because of the complexity of the integration issues associated with thermal, mechanical,

electrical, safety and packaging of cells into battery packs, we believe that seamless design tools that combine all of these aspects into one integrated software would increase the speed at which the battery packs could be designed. This in turn would reduce the product cycle time as well as the pack cost. For thermal design and management of cells and packs, NREL has developed a set of analysis tools that are used to aid engineering in order to understand the thermal performance of cells and batteries under various loads and environmental conditions as well as cooling/heating approaches. This design process/tool, depicted in Figure 9, uses various commercial software (codes) but it is not seamlessly integrated. Results from one tool need to be linked to another tool by an expert, and iterations could be lengthy.

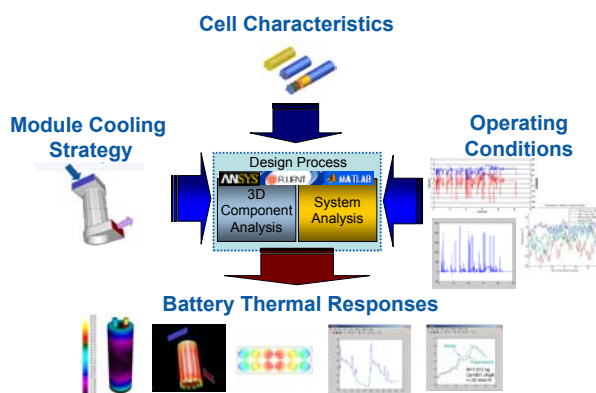

Figure 9: Example of a battery thermal design and analysis process [2]

This or similar processes need to be integrated into one code/software so it would be easier to use and to train engineers for the eventual goal of seamlessness. In addition to thermal design, the electrical design/analysis and control must also be added to this tool. However, including all temperature distributions of a cell into an electrical model may be too tasking computationally, so simplification may be needed. For example, at NREL we have developed a thermal and electrical integration network model of a multi-cell battery that assumes that each cell can be represented by five thermal nodes. The nodes provide temperature-dependent output resistance to the electrical model of a cell represented by an equivalent circuit modeling approach (Figure 10). Further work to develop these integrated

computer-aided engineering tools is needed to advance the state of the art of battery pack integration and to make battery packs less expensive.

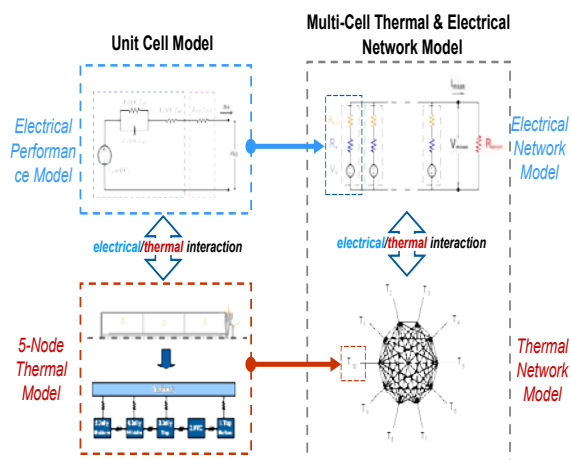

Figure 10: Example of an integrated thermal and electrical network model of a multi-cell battery

6 Concluding Remarks

Integration of cells into modules and then into battery packs is critical in achieving optimum battery cost, performance, and life. Many electrical, thermal, and mechanical issues must be considered. The smaller capacity cells allow for easier packaging of the battery system but result in a higher number of interconnects and failure points. The smaller capacity cells are also easier to keep isothermal due to their smaller size; however, providing cooling air of a consistent velocity and temperature to the cells becomes a more difficult problem. Incorporating larger capacity cells in an HEV or a PHEV limits the number of interconnects but also limits how the cells can be packaged within a vehicle. They also make it more difficult to keep the center of the cell isothermal because of the thermal path length. A computer-aided-engineering tool must be developed to address integration issues.

Acknowledgments

This work was sponsored by the United States Department of Energy, Office of Renewable Energy and Energy Efficiency, Vehicle Technologies Program. We would like to thank David Howell of Energy Storage R&D for his support.

References

- [1] Kevin Konecky, "Battery Integration Hybrid Vehicles," *Proceedings of the Advanced Automotive Battery Conference*, Tampa Bay, Florida, May 2008.
- [2] Ahmad Pesaran, "Battery Pack Integration for Plug-In Hybrid Vehicles," *Proceeding of the Plug-In 2008 Conference and Exhibit*, San Jose, CA, July 22-24, 2008
- [3] Delphi, "Electrical Control of HEV Batteries," *Proceedings of the Advanced Automotive Battery Conference*, Tampa Bay, Florida, May 2008.
- [4] G.H. Kim, A. Pesaran, "Analysis of Heat Dissipation in Li-Ion Cells and Modules for Modelling of Thermal Runaway," *Proceeding of 3rd International Symposium on Large Lithium Ion Battery Technology and Application*, Long Beach, California, May 15-18, 2007.
- [5] A. A. Pesaran, G. H. Kim, K. Smith, and E. Darcy, "Designing Safe Lithium Ion Battery Packs Using Thermal Abuse Models," *Proceedings of Lithium Mobil Power Conference*, December 7-8, 2008, Las Vegas, NV.

Authors



Ahmad A. Pesaran is a Principal Engineer at NREL and leads the energy storage team. Ahmad manages several projects for Department of Energy and industrial partners, which include thermal characterization and analysis of batteries as well as modelling and simulation for hybrid and plug-in hybrids. He holds a Ph.D. in thermal engineering from UCLA.



Gi-Heon Kim is a Senior Engineer at NREL. His recent research interests in advanced vehicle energy storage system tasks include development of a three-dimensional lithium ion battery thermal abuse model, a 3D electrochemical modelling of Li ion cells, and modelling hybrid electric vehicle/electric vehicle battery thermal management systems. He holds a Ph.D. from Colorado State University.



Matt Keyser is a Senior Engineer at NREL and manages the Energy Storage Lab for performing thermal and electrical characterization of batteries and ultracapacitors. Matt has tested many Li ion batteries and recently has designed and fabricated the largest battery calorimeter in the world that can measure heat from large modules and battery packs.

REPORT DOCUMENTATION PAGE

Form Approved
OMB No. 0704-0188

The public reporting burden for this collection of information is estimated to average 1 hour per response, including the time for reviewing instructions, searching existing data sources, gathering and maintaining the data needed, and completing and reviewing the collection of information. Send comments regarding this burden estimate or any other aspect of this collection of information, including suggestions for reducing the burden, to Department of Defense, Executive Services and Communications Directorate (0704-0188). Respondents should be aware that notwithstanding any other provision of law, no person shall be subject to any penalty for failing to comply with a collection of information if it does not display a currently valid OMB control number.

PLEASE DO NOT RETURN YOUR FORM TO THE ABOVE ORGANIZATION.

1. REPORT DATE (DD-MM-YYYY) May 2009			2. REPORT TYPE Conference Paper		3. DATES COVERED (From - To)	
4. TITLE AND SUBTITLE Integration Issues of Cells into Battery Packs for Plug-In and Hybrid Electric Vehicles: Preprint				5a. CONTRACT NUMBER DE-AC36-08-GO28308		
				5b. GRANT NUMBER		
				5c. PROGRAM ELEMENT NUMBER		
6. AUTHOR(S) A.A. Pesaran, G.H. Kim, and M. Keyser				5d. PROJECT NUMBER NREL/CP-540-45779		
				5e. TASK NUMBER FC08.6000		
				5f. WORK UNIT NUMBER		
7. PERFORMING ORGANIZATION NAME(S) AND ADDRESS(ES) National Renewable Energy Laboratory 1617 Cole Blvd. Golden, CO 80401-3393				8. PERFORMING ORGANIZATION REPORT NUMBER NREL/CP-540-45779		
9. SPONSORING/MONITORING AGENCY NAME(S) AND ADDRESS(ES)				10. SPONSOR/MONITOR'S ACRONYM(S) NREL		
				11. SPONSORING/MONITORING AGENCY REPORT NUMBER		
12. DISTRIBUTION AVAILABILITY STATEMENT National Technical Information Service U.S. Department of Commerce 5285 Port Royal Road Springfield, VA 22161						
13. SUPPLEMENTARY NOTES						
14. ABSTRACT (Maximum 200 Words) The main barriers to increased market share of hybrid electric vehicles (HEVs) and commercialization of plug-in HEVs are the cost, safety, and life of lithium ion batteries. Significant effort is being directed to address these issues for lithium ion cells. However, even the best cells may not perform as well when integrated into packs for vehicles because of the environment in which vehicles operate. This paper discusses mechanical, electrical, and thermal integration issues and vehicle interface issues that could impact the cost, life, and safety of the system. It also compares the advantages and disadvantages of using many small cells versus a few large cells and using prismatic cells versus cylindrical cells.						
15. SUBJECT TERMS lithium battery; battery management; battery cooling; electric drive; battery modelling; vehicle thermal management; hybrid electric vehicles						
16. SECURITY CLASSIFICATION OF:			17. LIMITATION OF ABSTRACT UL	18. NUMBER OF PAGES	19a. NAME OF RESPONSIBLE PERSON	
a. REPORT Unclassified	b. ABSTRACT Unclassified	c. THIS PAGE Unclassified			19b. TELEPHONE NUMBER (Include area code)	