

Analysis of Heat Dissipation in Li-Ion Cells & Modules for Modeling of Thermal Runaway

The 3rd International Symposium on

Large Lithium Ion Battery Technology and Application

May 15, 2007

Long Beach, California

Gi-Heon Kim (gi_heon_kim@nrel.gov)

Ahmad Pesaran (ahmad_pesaran@nrel.gov)

National Renewable Energy Laboratory

Golden, Colorado

Supported by

Energy Storage Program

Office of FreedomCAR and Vehicle Technologies

Office of Energy Efficiency and Renewable Energy

U.S. Department of Energy



NREL/PR-540-41531



Motivations for This Study

- Li-Ion batteries need to be safe and abuse tolerant for high penetration into hybrid vehicle market.
- Understanding abuse behavior of Li-Ion batteries and addressing it are part of the DOE/FreedomCAR and USABC Programs.
- Thermal abuse behavior of Li-Ion batteries are expected to be affected by the local distributions of heat and reacting materials.
- The impact of cell-internal-structures and spatial variations of temperature and materials is expected to be critical, especially in large format cells.
- *Modeling the multi-dimensional thermal/chemical phenomena in Li-Ion batteries could provide a better understanding of thermal runaway.*

Objectives of This Study

- To develop 3D Li-Ion battery thermal abuse “reaction” models for cell and module analysis.
- To understand the mechanisms and interactions between heat transfer and chemical reactions during thermal runaway for Li-Ion cells and modules.
- To develop a tool and methodology to support the design of abuse-tolerant Li-Ion battery systems for PHEVs/HEVs.
- To help battery developers accelerate delivery of abuse-tolerant Li-Ion battery systems in support of the FreedomCAR’s Energy Storage Program.

Thermal Runaway: Which processes could be modeled?

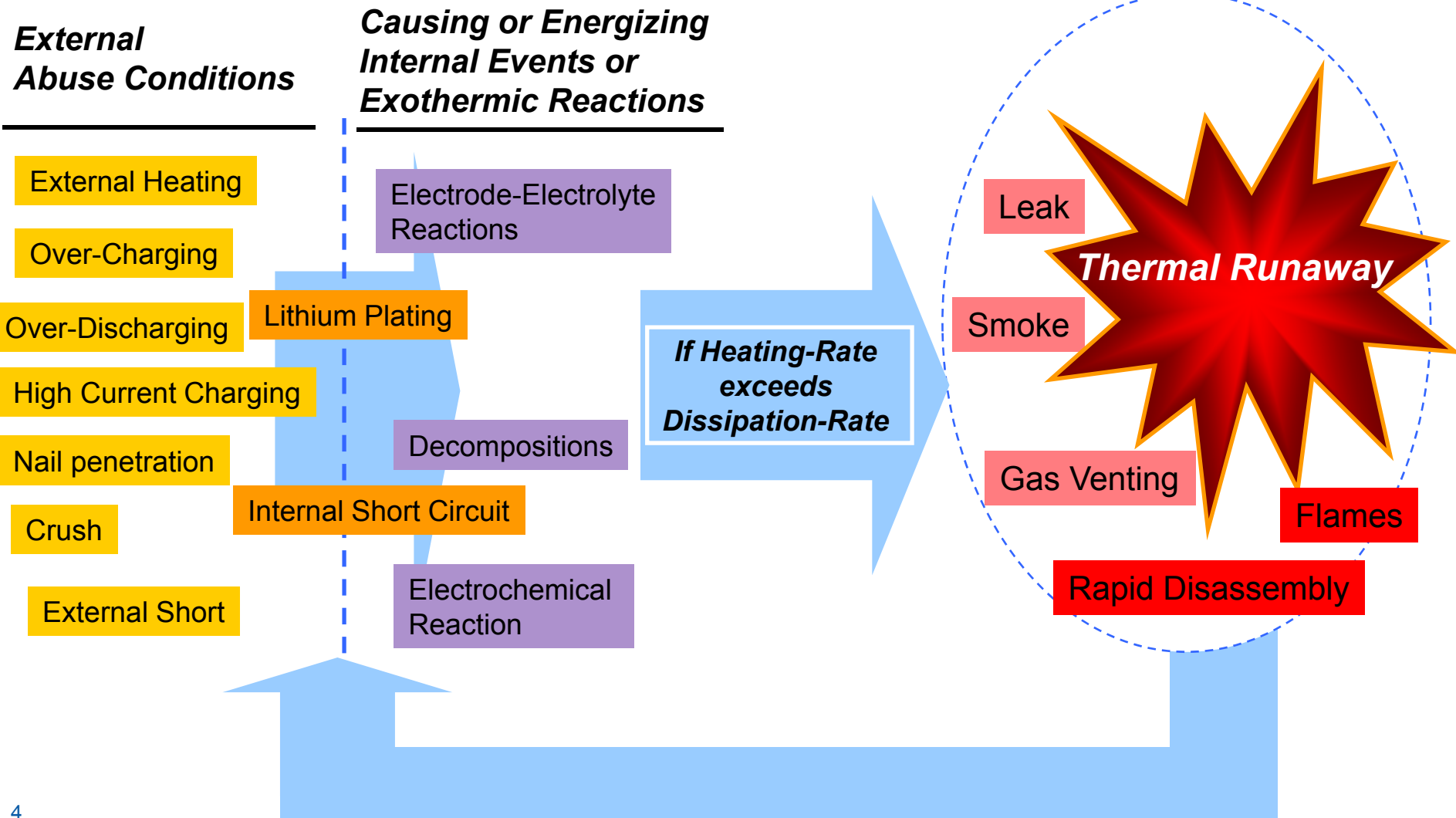

Approach and Model Capabilities

Approach

- Reviewed literature for chemical reactions in Li-Ion batteries and consulted with experts (Robert Spotnitz of Battery Design).
- Incorporated exothermic component reactions commonly accepted.
- Formulated and implemented exothermic chemistries into the 3D model.
- Collected physical/chemical cell properties and parameters for the model.
- Constructed ***thermal-chemistry*** coupled models in cells and modules.
- Performed simulations of oven and localized heating

Model Capabilities

- Capturing thermal paths inside a cell by addressing actual geometries/properties of cell components.
- Simulating behavior under various thermal conditions by considering local cooling/heating effects.
- Predicting the thermal runaway propagation through a module.

Reaction Model

Not an electrical or electrochemical model.

- We reproduced the approach to modeling thermal abuse of lithium-ion cells provided by Hatchard et al. (*J. Electrochem. Soc.*, 148, 2001)
- Extended it for our three-dimensional cell and module analysis.

Reactions Considered

- SEI decomposition
- Negative-Solvent reaction
- Positive-Solvent reaction
- Electrolyte decomposition

NOTE: Lithium metal involved reactions (that are important in overcharge conditions) and combustion reactions were not considered in this version of the model. We plan to include them in the next version.

Our model compares well with literature model for Oven Heating (155°C) **LiCoO₂/graphite cell**

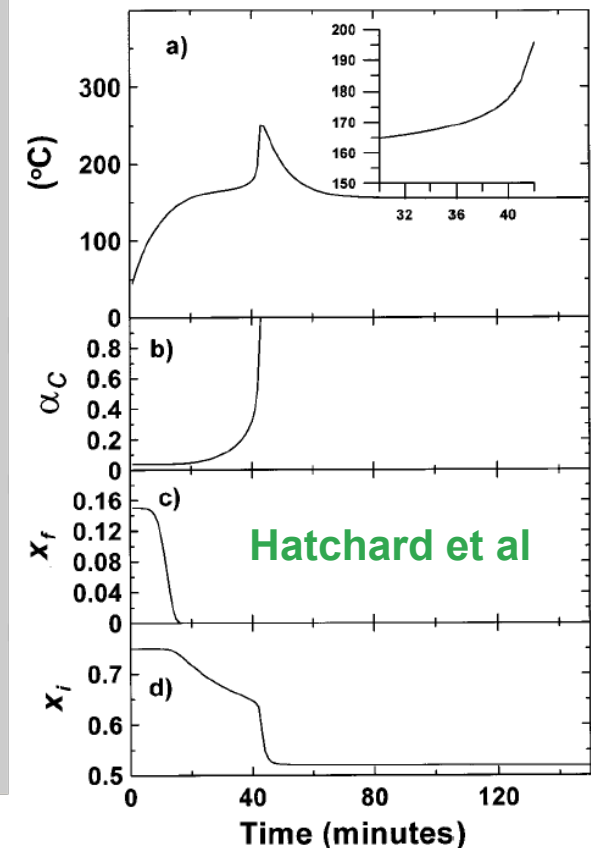
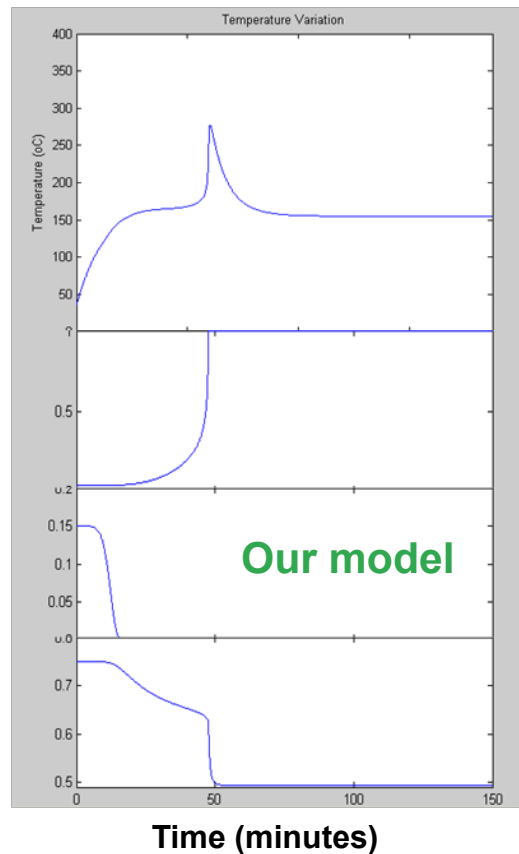

3D Battery Model

Addressing:

- Effect of non-uniform distributions
- Effect of thermal/electrical path design inside cells/batteries
- Effect of localized heating/cooling
- Effect of geometries; shape and dimensions of cell component

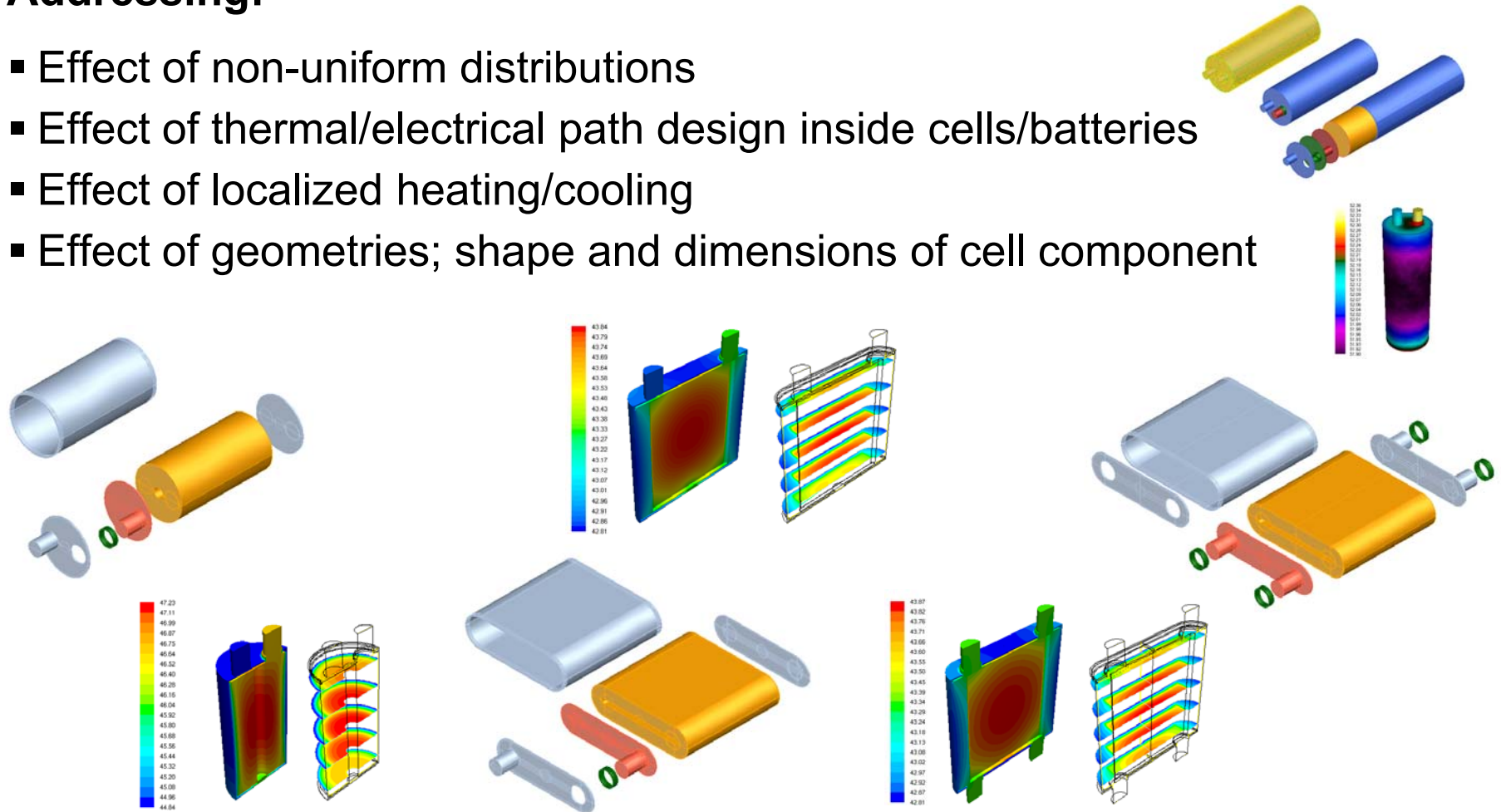

Cell Level Thermal Abuse Analysis

3D Oven Test Simulation

- Battery is initially at a normal operating temperature (35°C).
- Battery is placed in an oven which is preheated at the desired test temperature.
- Oven temperature is kept constant during test.

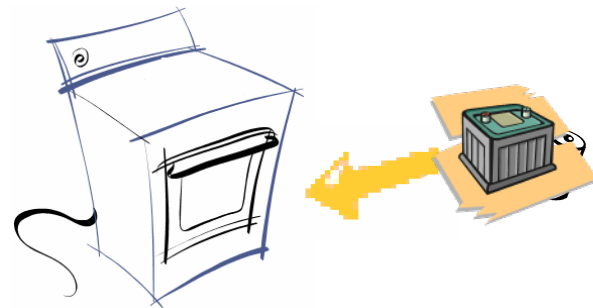

½ Model with Symmetry Plane

Heat Sources

- SEI decomposition
- Negative-solvent reaction
- Positive-solvent reaction
- Electrolyte decomposition

Core Material

- Cylindrically orthotropic properties (direction dependent)

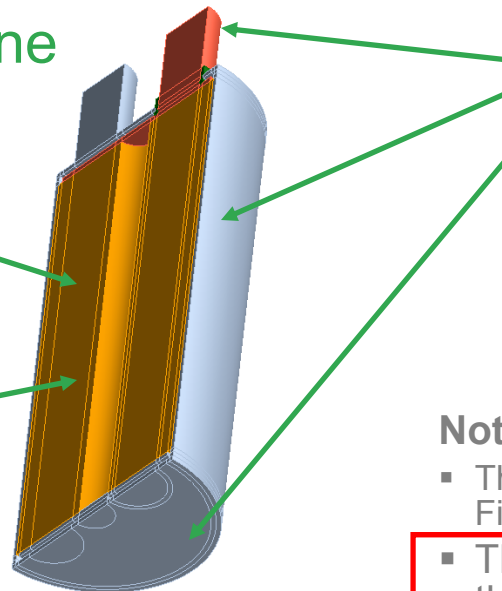

Exterior Surface Boundary Condition

- Natural convection
- Black-body irradiation
- Gray surface
- Conduction

Note

- The model was developed based on Finite Volume Method.
- The can/case is electrically and thermally connected to one of the terminals.

Oven Temperature & Size Impact Onset of Events

Color Key

	18650 Cells	Oval Cell	50900 Cells
V_{jr} (cc)	10.52	157.1	157.1
A/V_{jr} (1/m)	48.37	29.14	25.01

V_{jr} : Jelly Roll Volume

A/V_{jr} : Heat Exchange Area per Volume

Small cell did not go into thermal runaway at 150°C

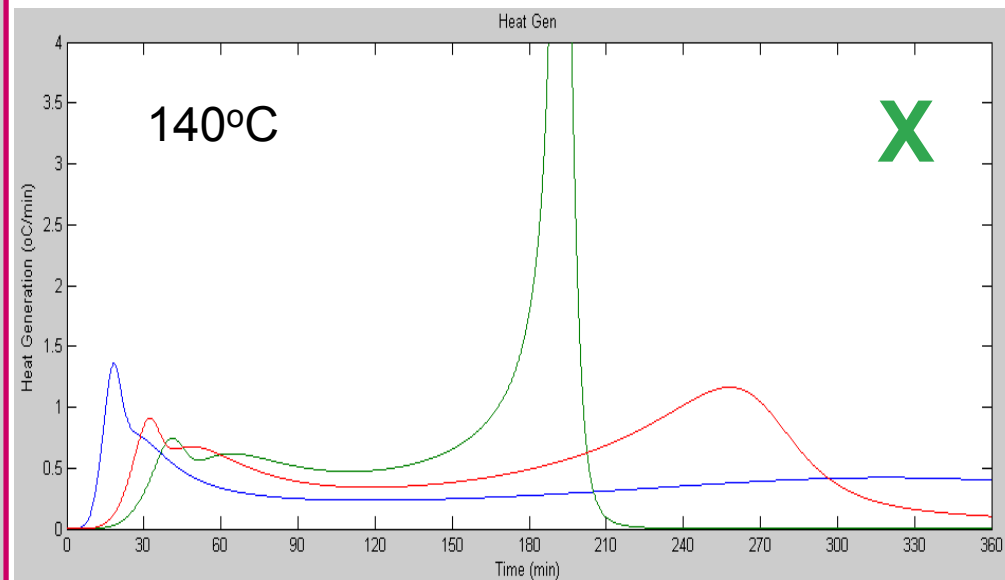
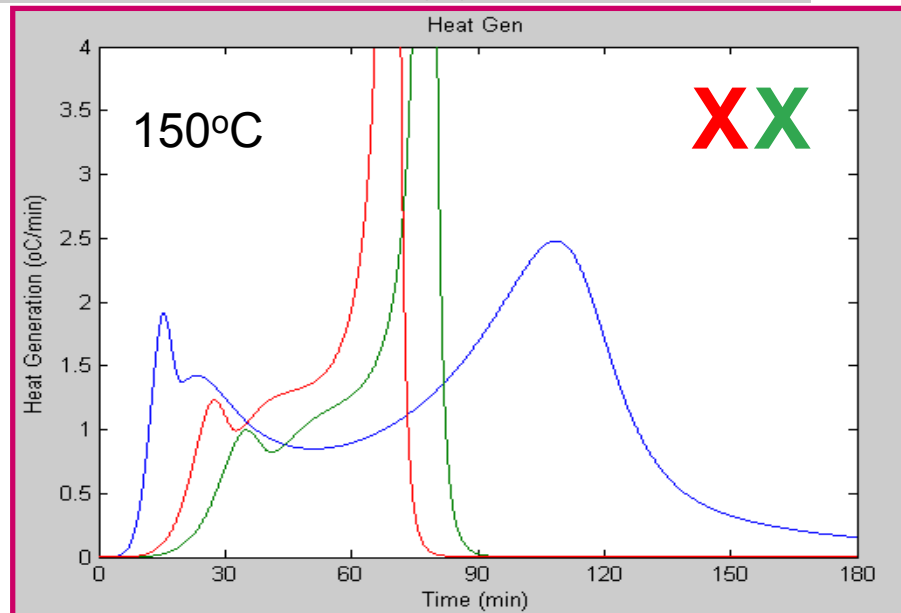
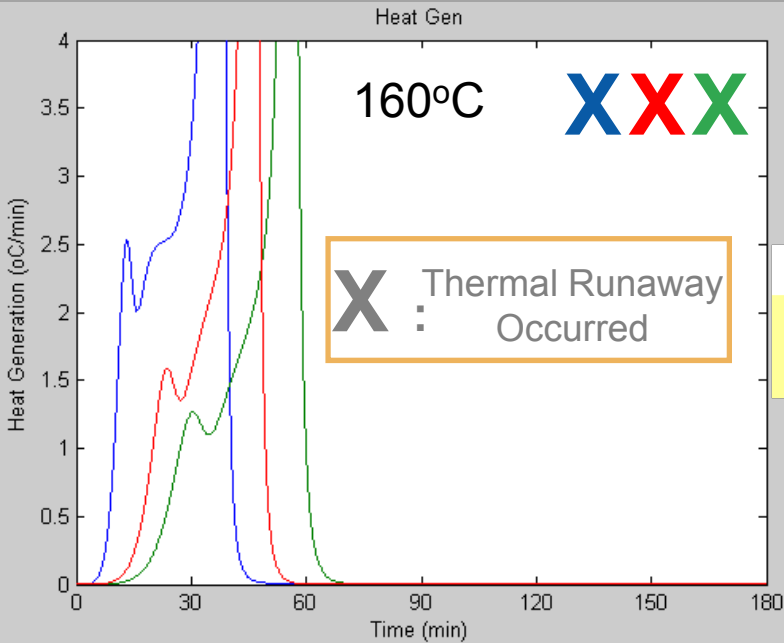

(D18H65)* **Temperature, Heat**

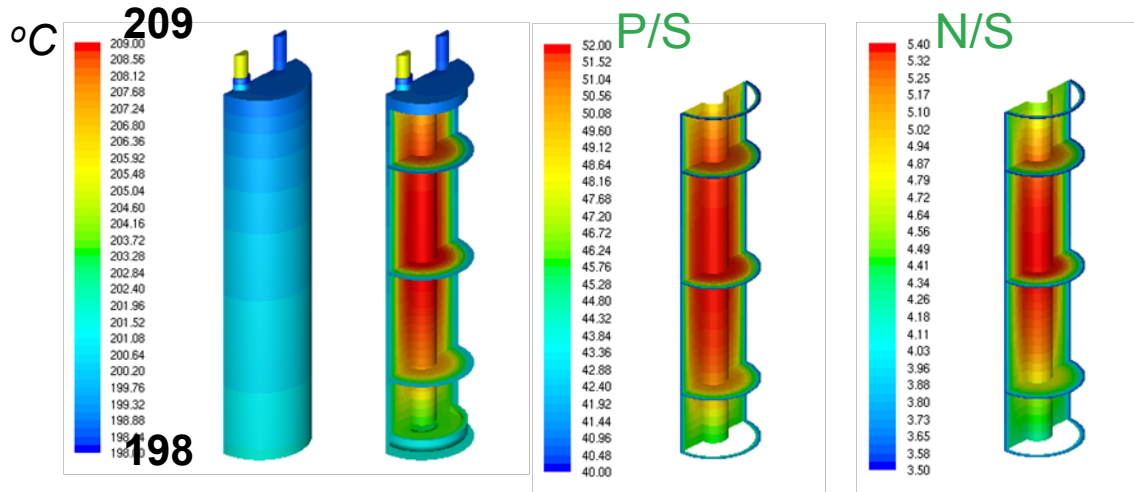

Although oven test is not a highly multi-dimensional phenomena, it still demonstrates the noticeable spatial distribution especially in large cells.

D18H65: Diameter of 18 mm, Height of 65 mm (D50H90)

Temperature, Heat

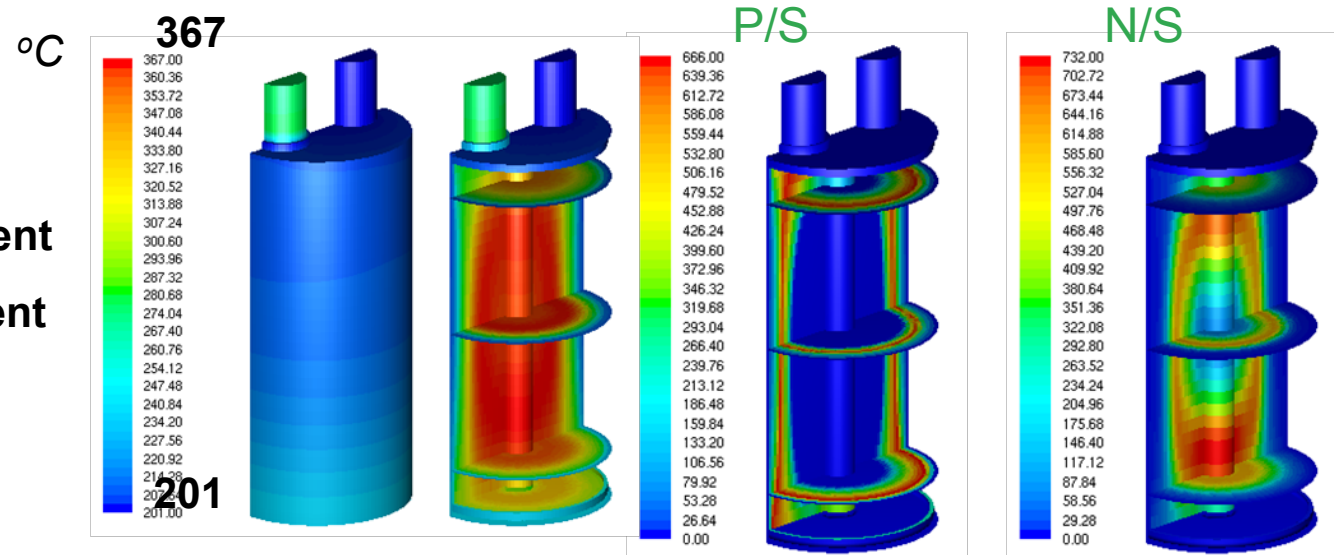

P/S: positive/cathode -solvent

N/S: negative/anode-solvent

Simulating Localized Heating (It may represent internal short circuit!)

½ Model with Symmetry Plane

Hot-Spots

- Localized energy would be released in a short period of time at an arbitrary small region inside a cell core.

Heat Sources

- SEI decomposition
- Negative-solvent reaction
- Positive-solvent reaction
- Electrolyte decomposition
- No resistive/Joules heating

Core Material

- Cylindrically Orthotropic Properties

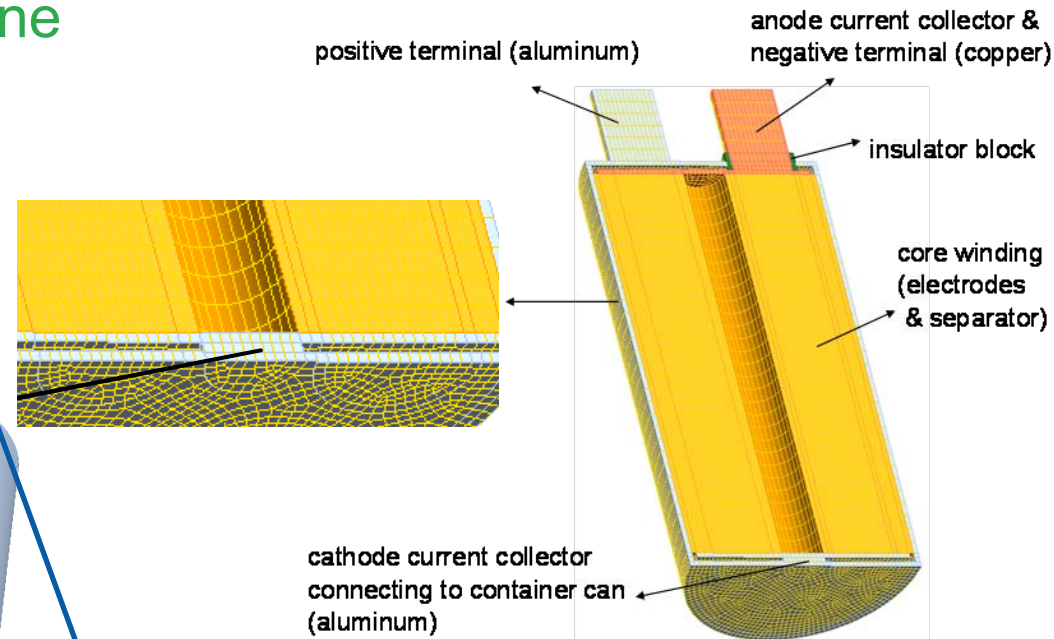

Note

- The can is electrically/thermally connected to the core at the bottom

Localized Boundary Conditions

- Each boundary section can have various boundary conditions independently
- Natural/forced convection
- Gray-body radiation

Internal Propagation

Abuse reaction propagation depends on cell internal structures and materials.

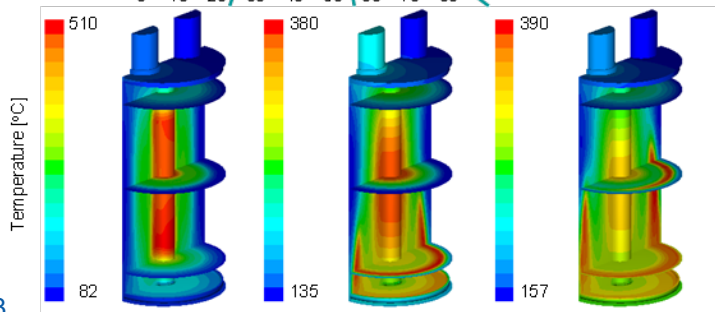
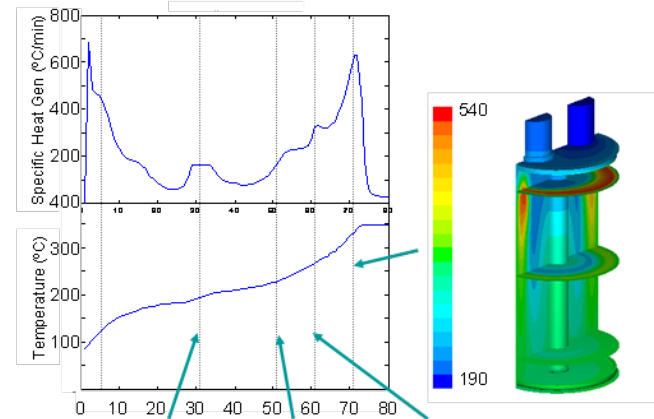
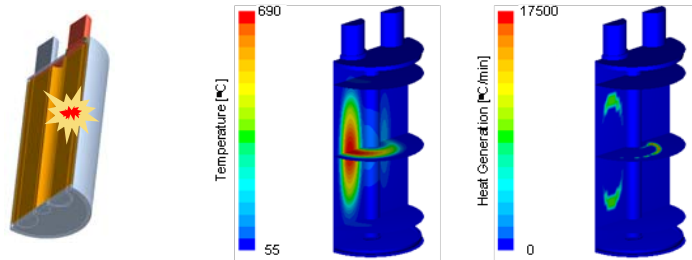

Simulation Conditions

- D50H90 size cell
- A certain amount of energy (equivalent to 15% of stored energy in the presented case) is released at small portion of core volume (0.5% of total jelly volume) for 1 sec.

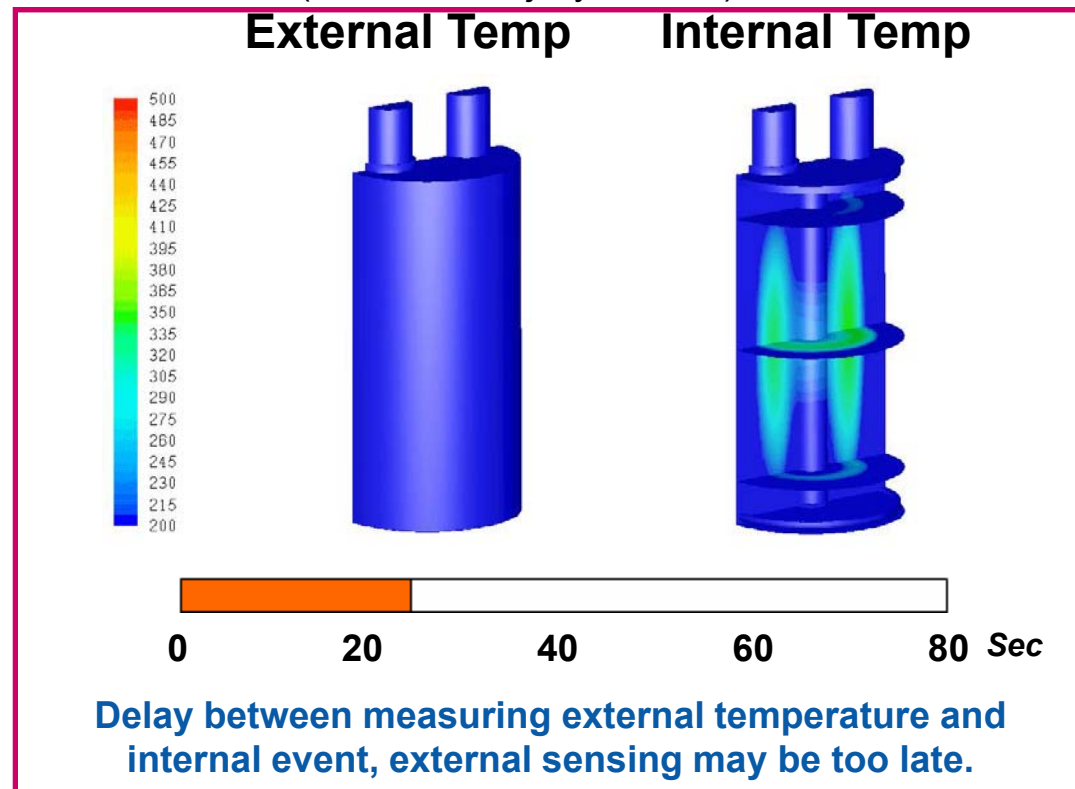

Reaction Front Propagation

SEI decomposition reaction completion surface



Reaction Propagation

- Propagates Initially in azimuthal direction
- Forms hollow cylinder shape reaction zone
- Center axis zone starts to react
- Finally reaction goes further in outer radius cylinder zone

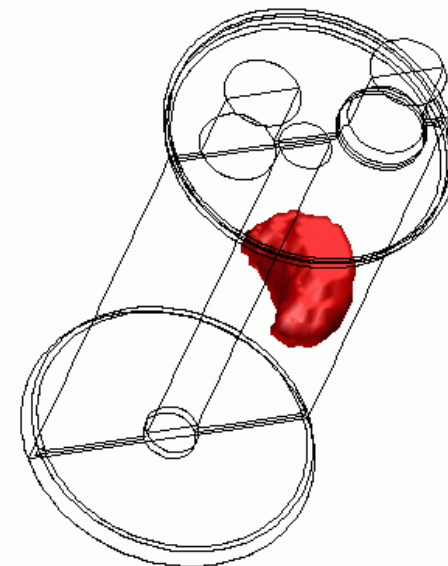

Module Level Analysis of Cell-to-Cell Thermal Runaway Propagation

If one cell goes into thermal runaway, will it propagate to other cells and how?

Cell-Cell Propagation in a Module....

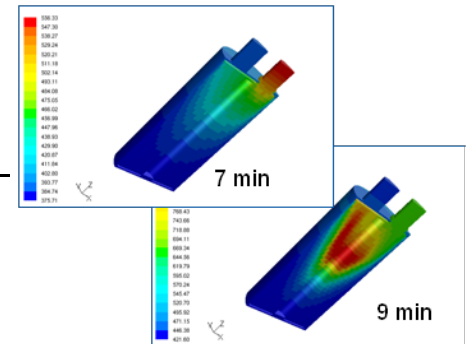
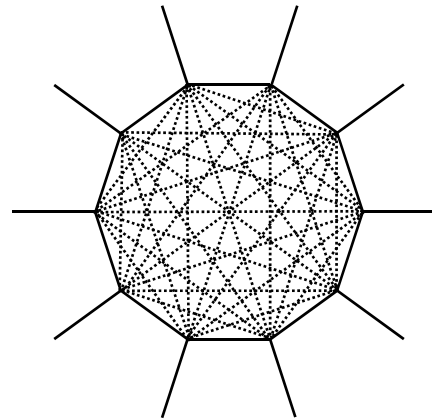
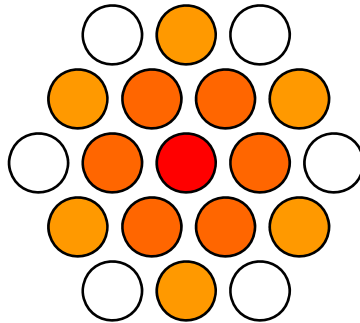

....is a result of **INTERACTION** between the *distributed chemical resources* and the *thermal transport network* through a module.

Heat Exchange Modeling in a Module

- **Radiation Heat Transfer:** Long range heat transfer through electro-magnetic wave emission/absorption at cell surfaces.
- **Conduction Heat Transfer:** Thermal diffusion through cell to cell electric connector (and/or conductive structures).
- **Convection Heat Transfer:** Heat transfer due to bulk motion of heat transfer medium.

Approach to Thermal Runaway Propagation

A Multi-Node Lumped System Model for Module Propagation Analysis

- Each cell in a module and ambient (or a container box) were considered as thermally lumped systems; $[N+1]$ nodes were solved.
- Thermal-chemistry coupled equations are solved at each node.**
- Limitations:
 - Venting and convection heat transfer due to the venting were not considered in this study.
 - Model does not consider flames due to venting of the flammable electrolyte.
 - Structural integrity of cells and module are assumed to be intact even at high temperatures.

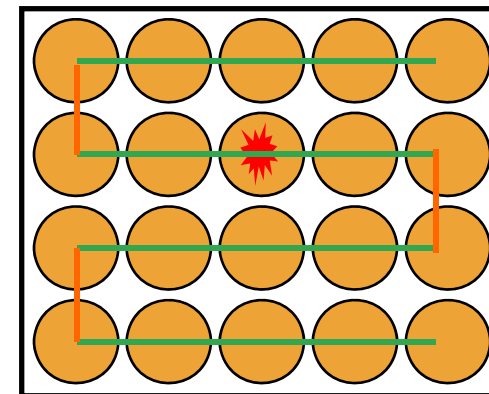

BASE CASE

- Module consists of 20 D50H90 Cells
- 5 x 4 aligned array spaced by 3 mm
- Radiation & terminal conduction
- Assume one cell is gone in to thermal runaway 

Note: Lumped approach tends to underestimate the thermal runaway propagation due to the lack of capability addressing local heating.

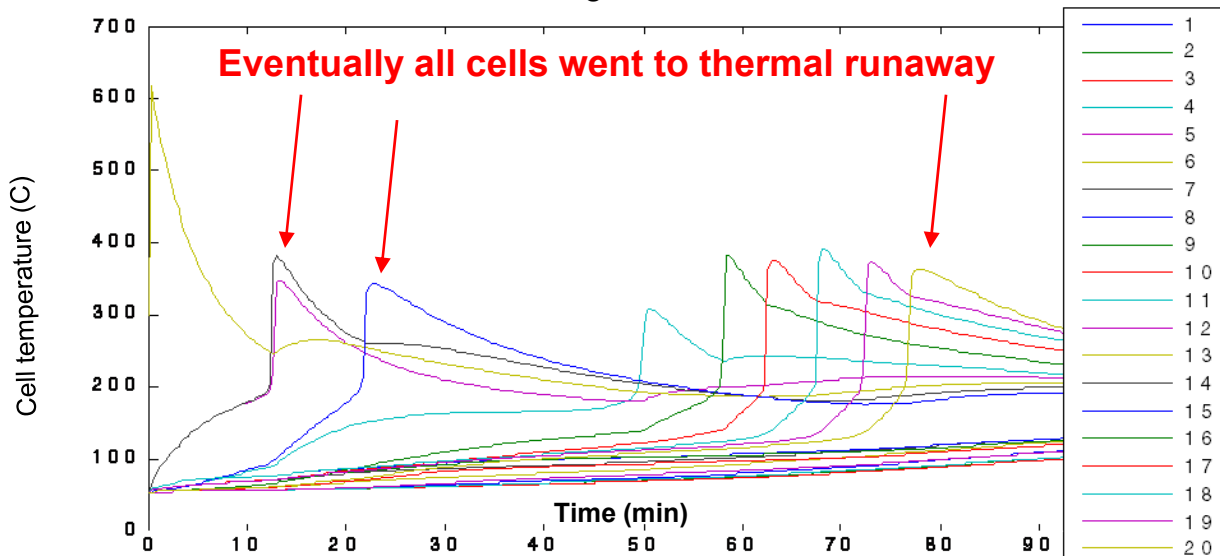

Base Case – Explaining the Results: Heat Sharing with immediate neighboring cells?

Heat flows from the trigger cell  to its neighbors through radiation and connector conduction (→ neighboring cells went into thermal runaway).

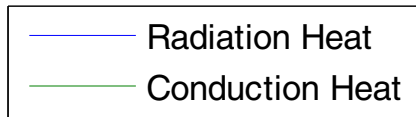

+ : Heat Rejection from trigger cell
- : Heat Absorption at trigger cell

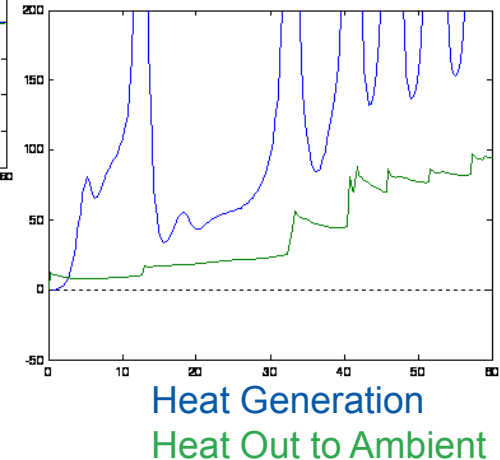
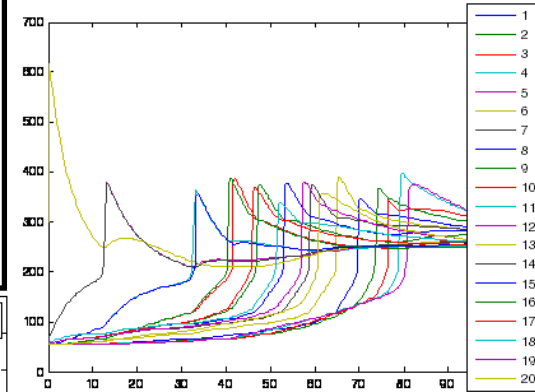
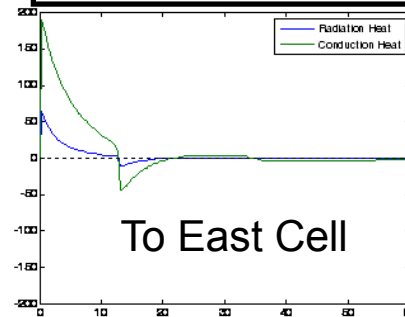
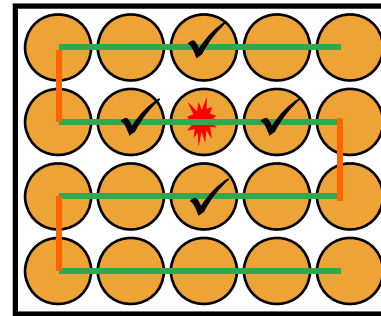
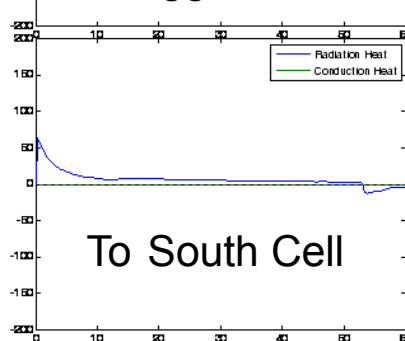
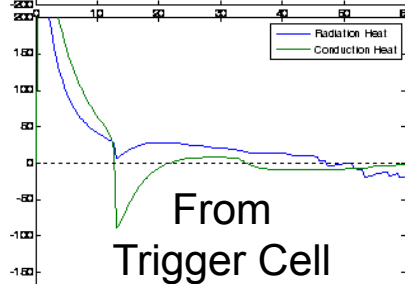
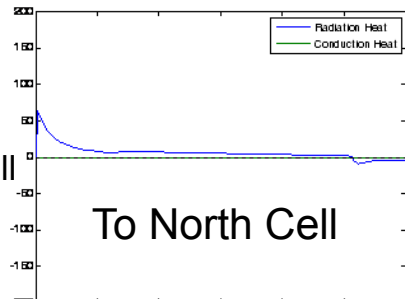
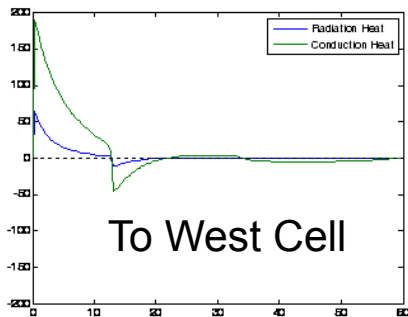

Base Case – Explaining the Results: Heat generation and transfer at neighboring cells

Enough heat reached the surrounding cells to trigger their thermal runaway.

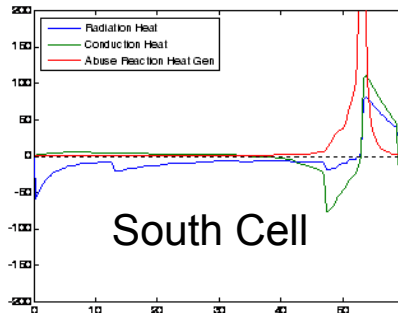
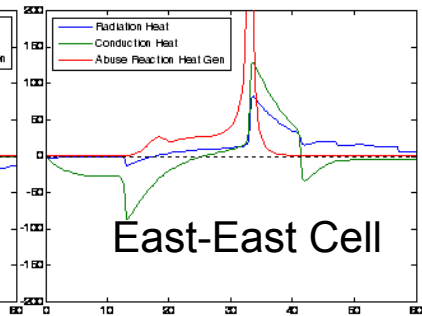
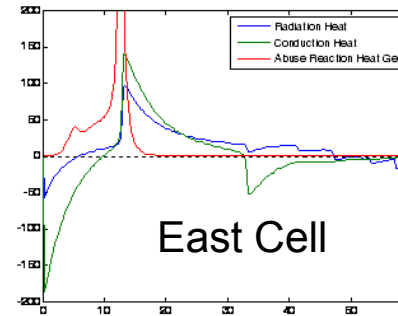
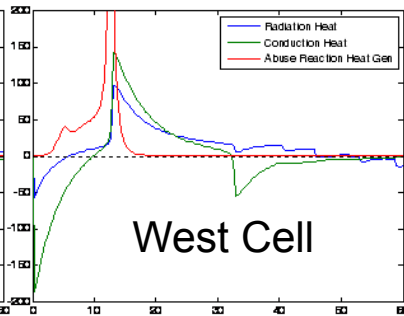
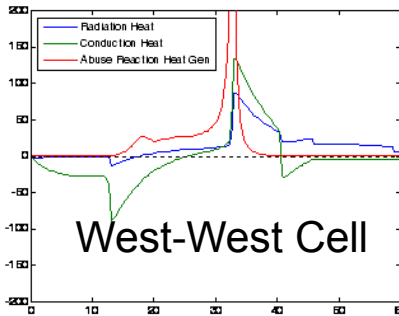
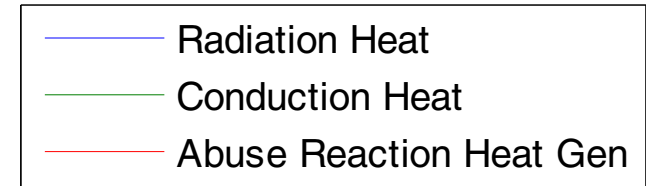
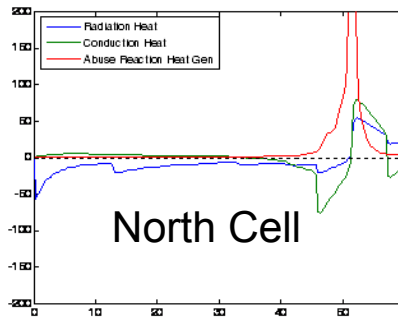
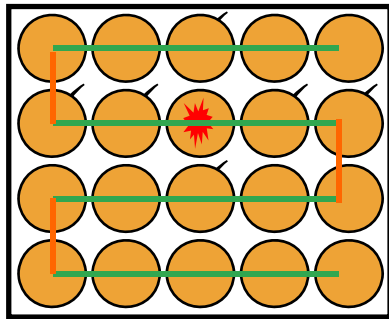

Impact of Smaller Cell-to-Cell Connector Size

Base Case

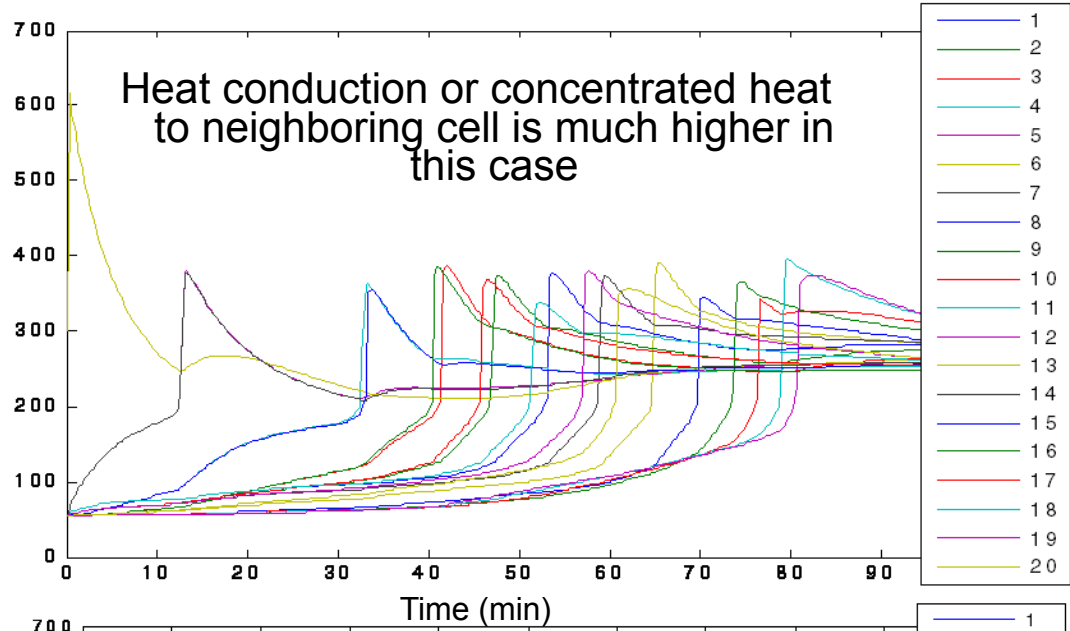
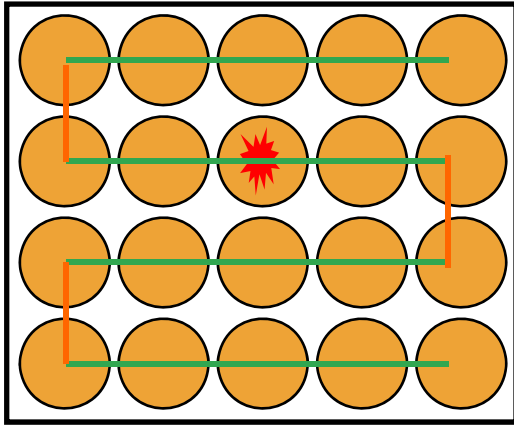

Base Case

Smaller Connector

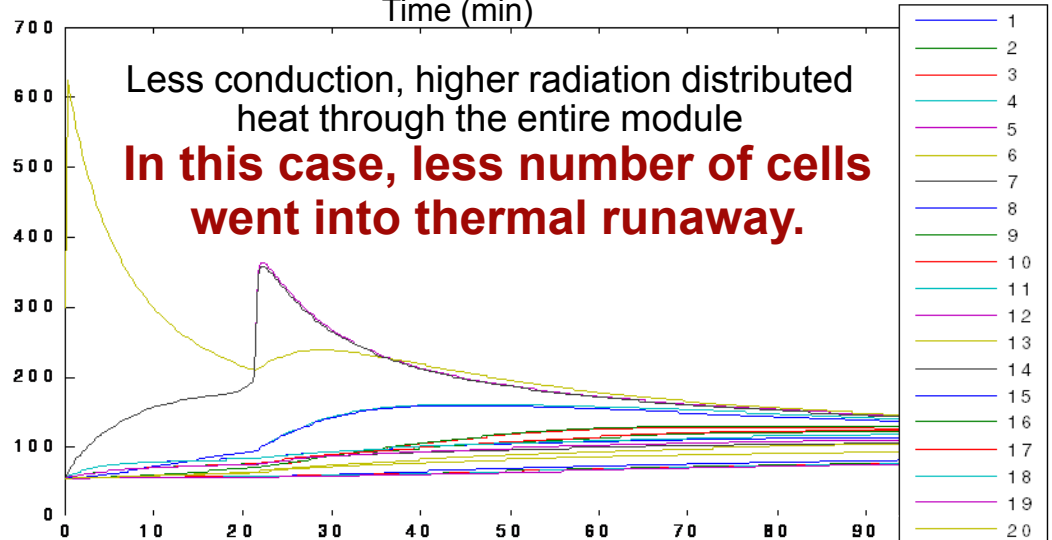
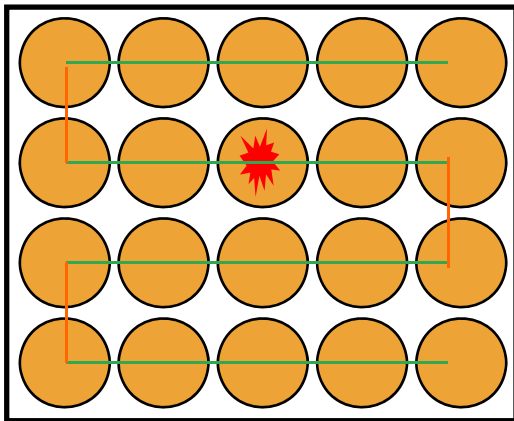

Smaller Connector

Impact of How Cells are Connected Electrically (Configuration)

Connector configurations can be electrically identical, but thermally different.

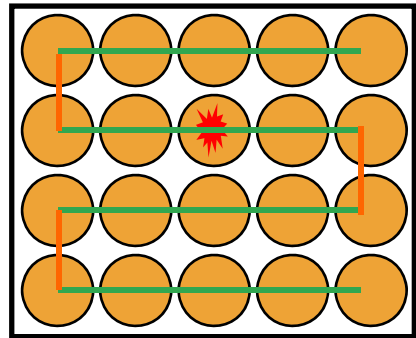

Base Case
(Thermally serial)

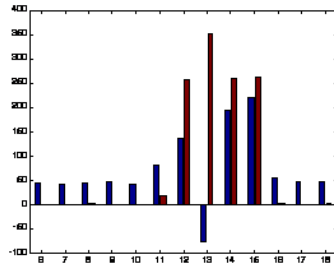

Node #

■ Accumulated Heat
■ Reaction Heat

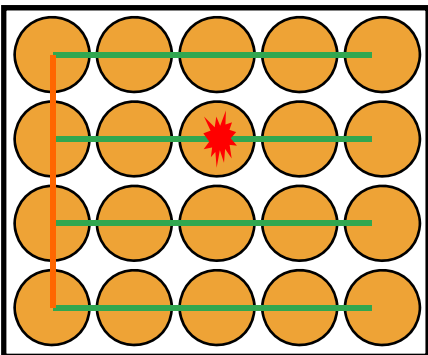

Thermally branched

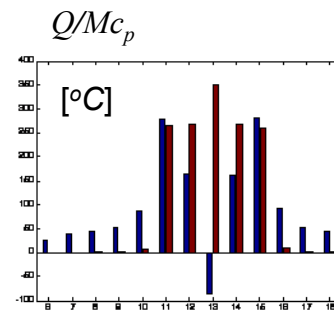

Node #

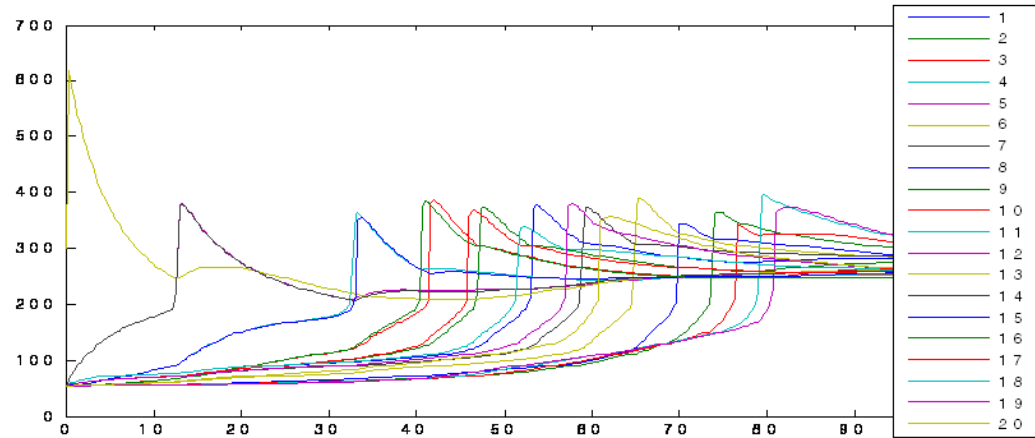

Time (min)

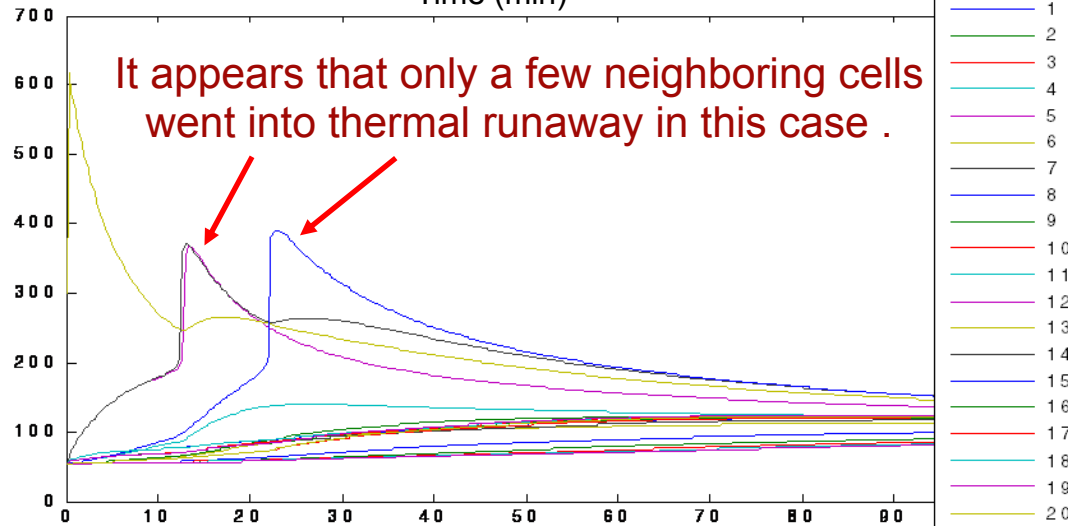

Impact of Cell Size on Thermal Propagation

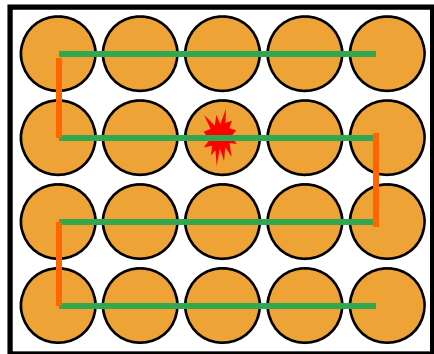

Base Case
(D50H90)

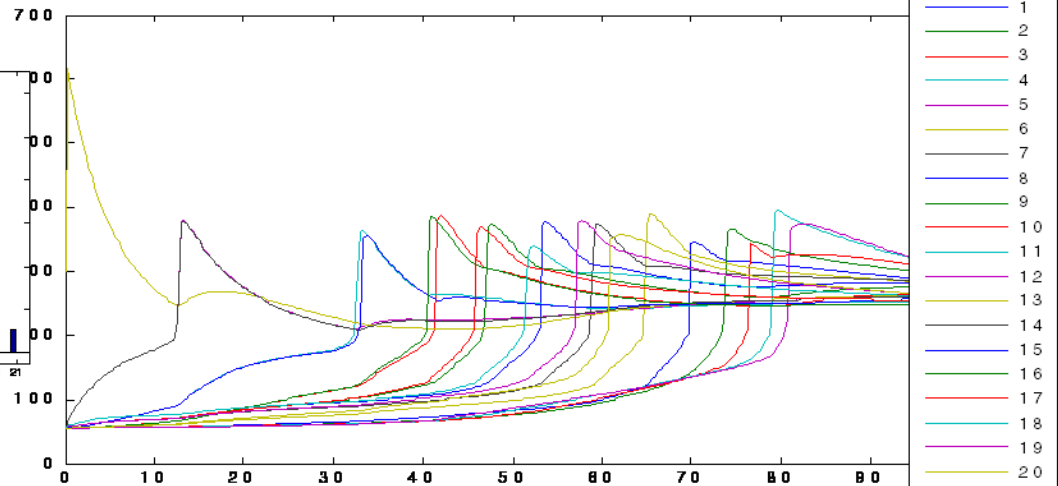
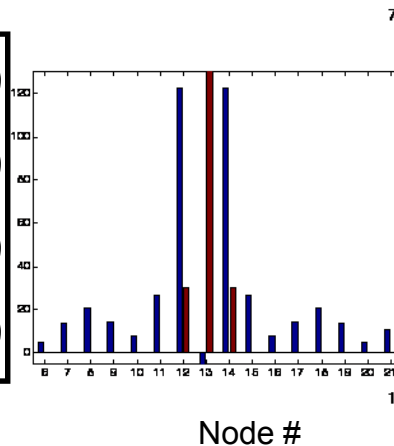

■ Accumulated Heat
■ Reaction Heat

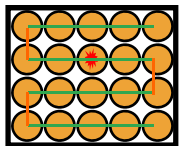
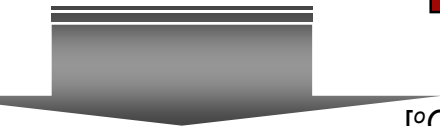

Small Cell Case
(D18H65)

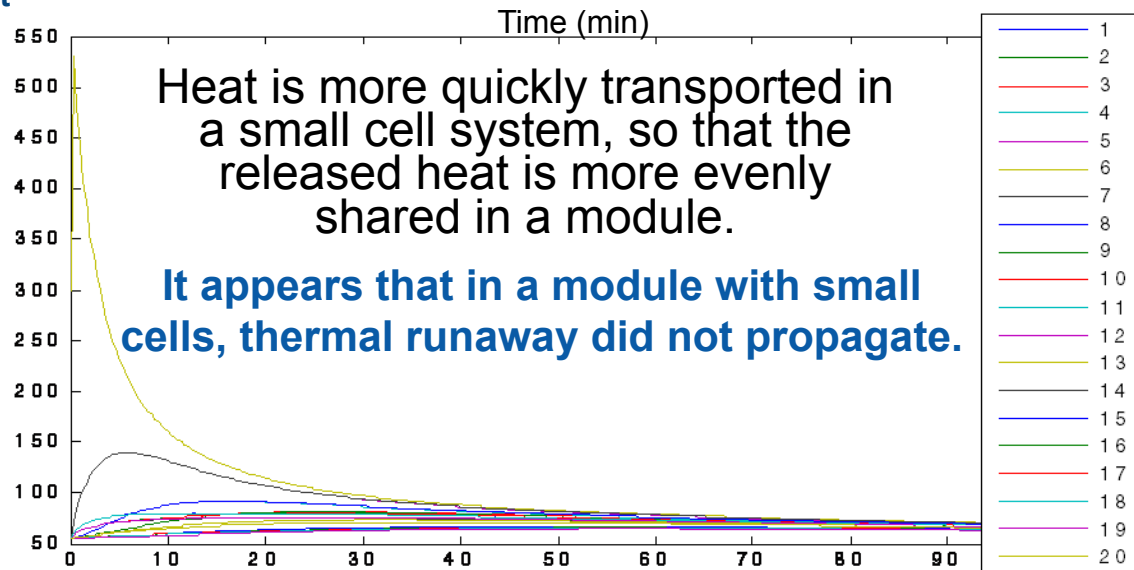
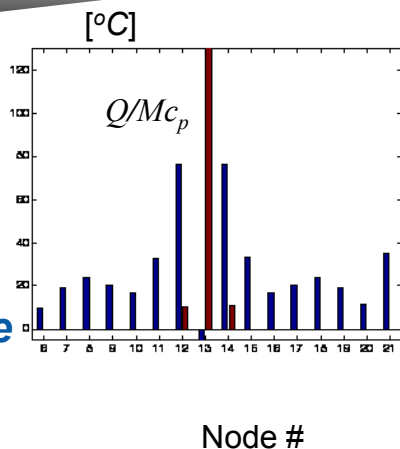

Impact of a Thermally-Conductive Matrix as Medium

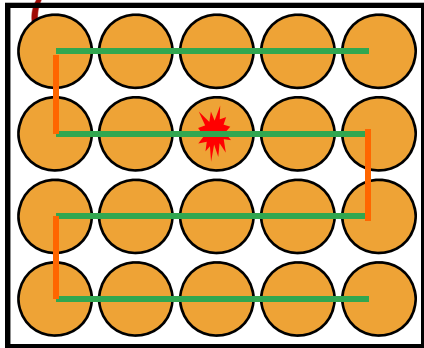

Base Case - Air

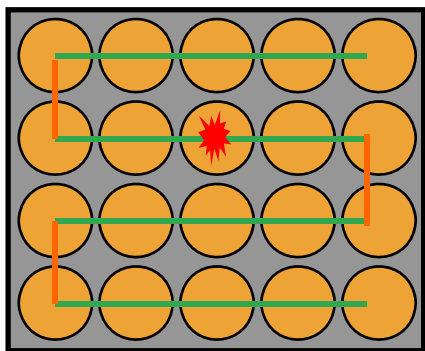
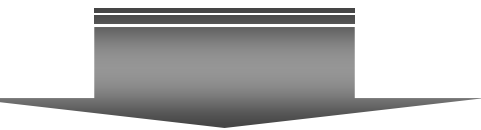
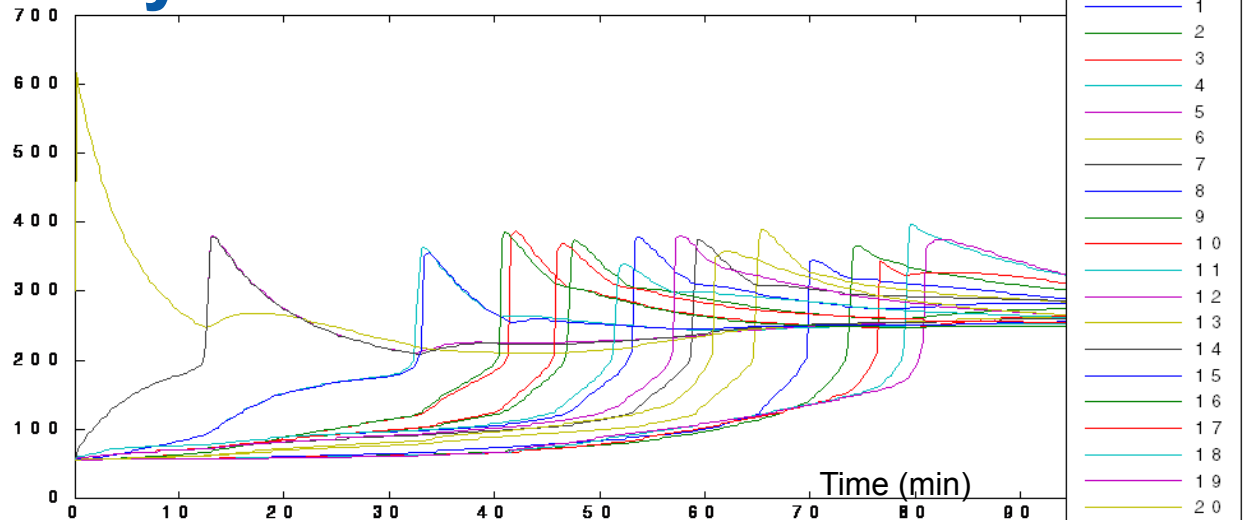

PCM/Graphite Imbedded Matrix*

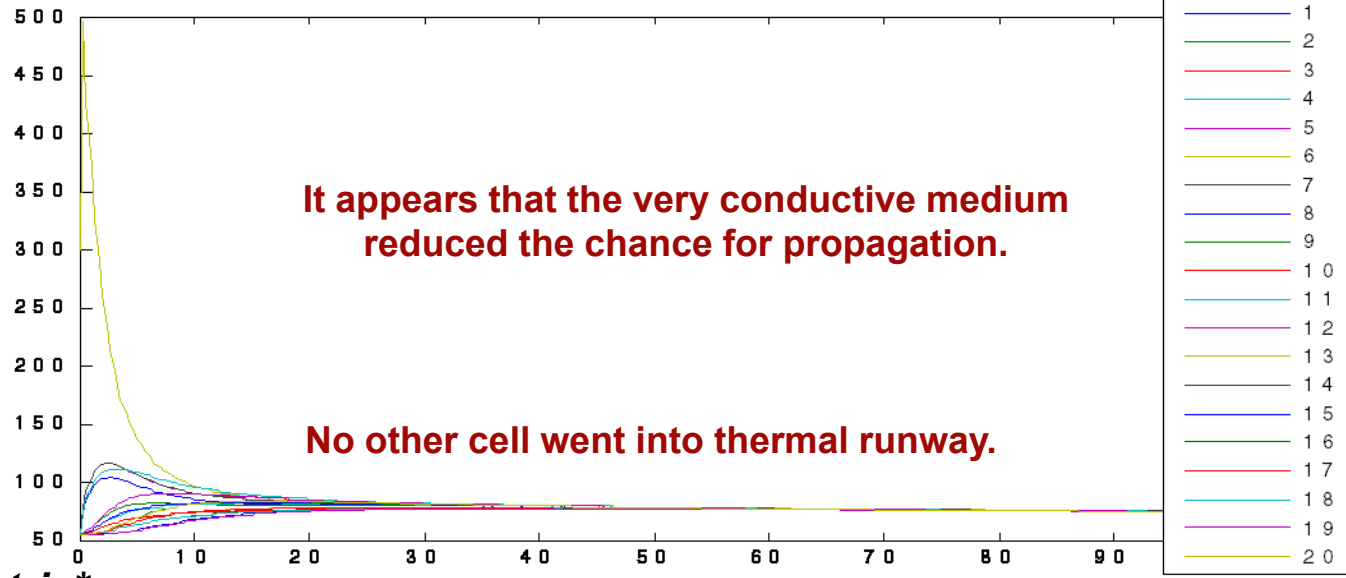

How Thermally-Conductive Matrix Help?

Heat-flow time integration for first 10 min

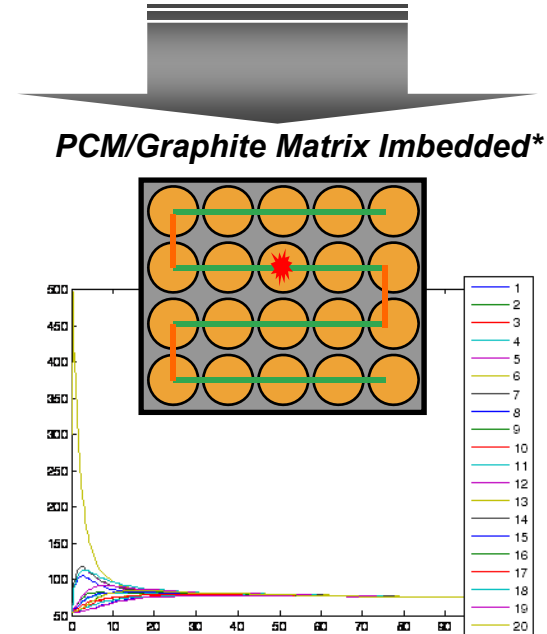
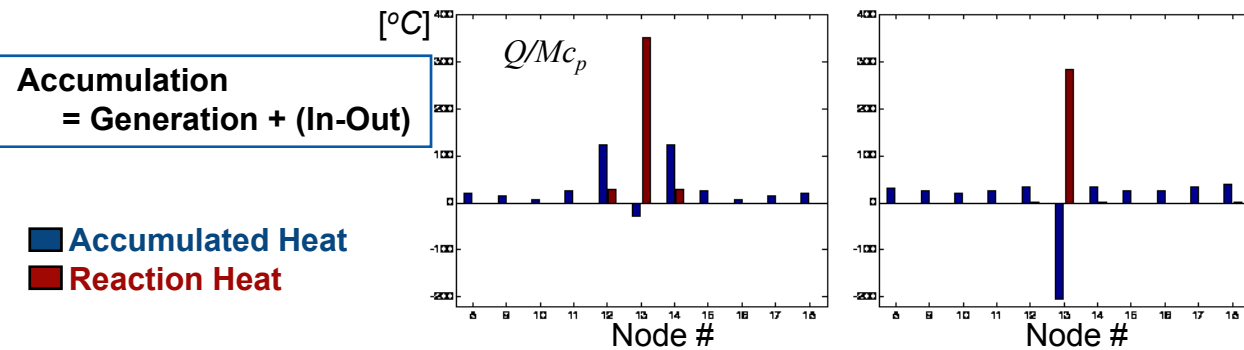
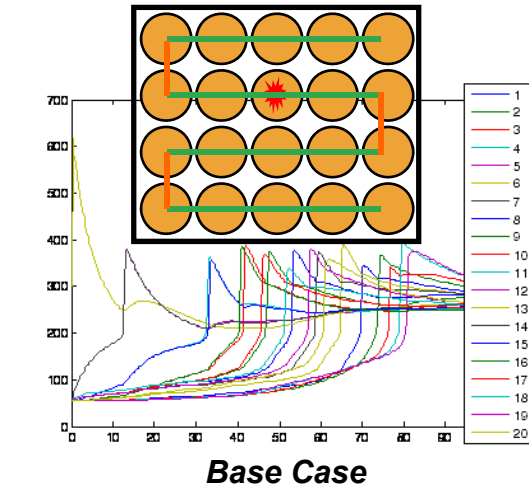
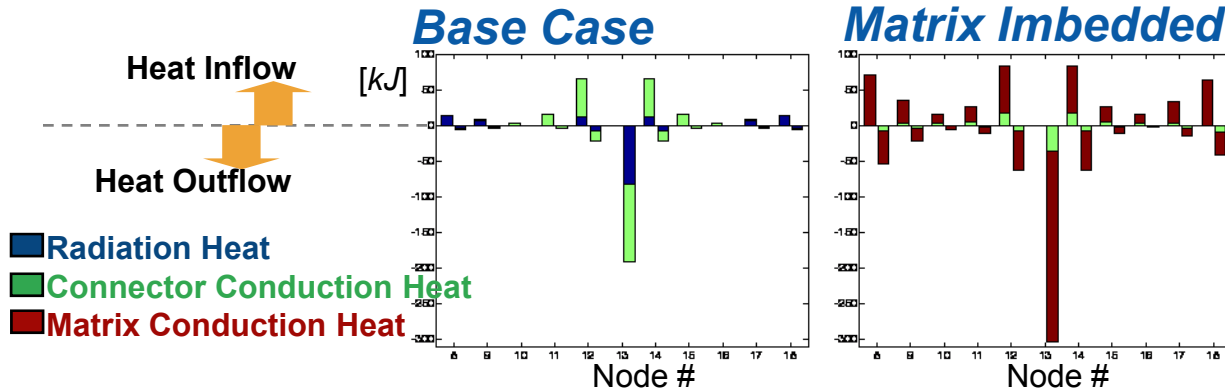

- High conductivity matrix provides “High-Speed” thermal network among the cells in a module.
- Matrix conduction (distributing network) dominates heat transfer between the thermal nodes over the connector conduction (concentrating network).

What is the message?

Is Fast or Slow Heat Transfer from “Hot” Cell Good or Bad?

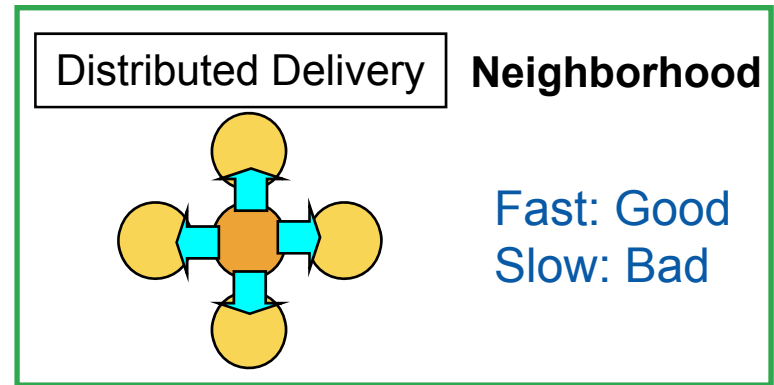
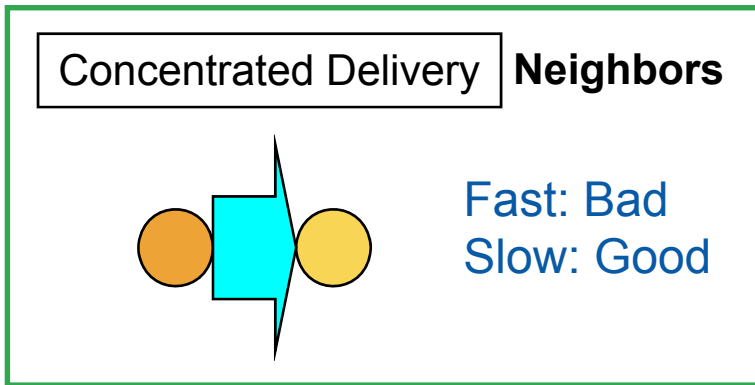

Example: Thin series connector and Thick parallel connector are good for propagation-resistive design

Which one is preferred for thermal design?

Electrically 6 in Parallel, 4 in Series

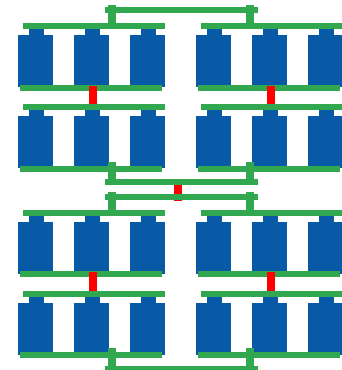
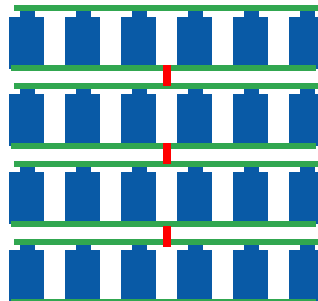
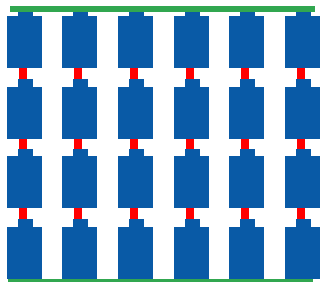

Is the answer always true?

Concluding Remarks on Propagation in Module

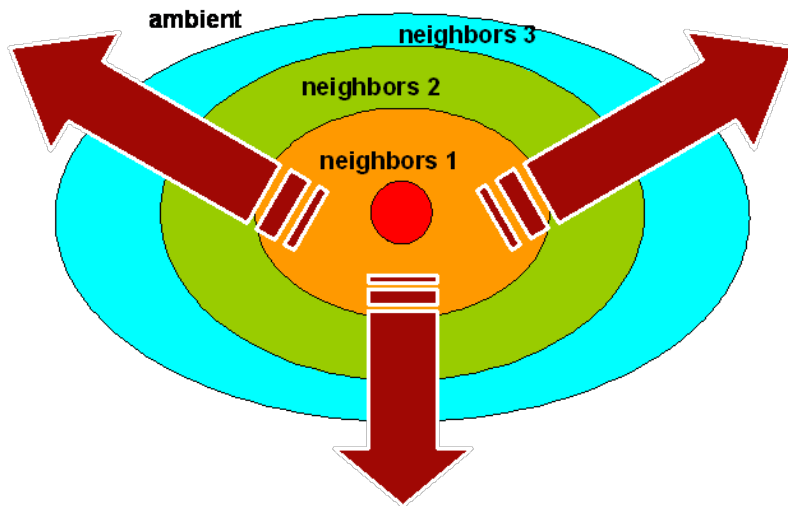

- Thermal runaway propagation is determined by the competition between heat dissipation through thermal network and localized heat generations.
- Even with a “High Speed” thermal network, if a large amount of heat is released from a localized source that exceed the capacity of “the network”, then the thermal propagation occurs in a greater speed through this “High Speed” network.

Propagation in module is ...

A result of **INTERACTION** between the *thermal transport network* and the *distributed chemical resources* through a module.

Summary

- Li-Ion Reaction chemistry was implemented into a finite volume 3D **cell** model addressing various design elements.
 - Simulated “oven test” indicated that cell size (to say precisely, heat transfer area per unit volume) greatly affects thermal behavior of a cell.
 - Simulated a localized heat release, similar to an internal short-circuit.
- Propagation of abuse reaction through a **module** was simulated.
 - A complicated balance between **heat transfer network** and **distributed chemical resources**.
 - This balance is affected by cell size, configuration and size of cell-cell connectors, and cell-cell heat transfer medium.
- A feature designed for improved normal operation may or may not be advantageous to prevent cell-to-cell thermal propagation and vice versa.

Future Work

- Improve model by comparing with experimental data from other Labs.
- Address limitation of the model
 - The impact of convective heat transport on module thermal runaway propagation by properly quantifying its contribution – include venting.
- Expand the model capability to address various chemistries and materials such as iron phosphate.
- Investigate internal/external short by incorporating thermally coupled electrochemistry model into the three dimensional cell model.
- Work with developers on specific cell and module designs.

Acknowledgments

DOE and FreedomCAR Program Support

- Tien Duong
- Dave Howell



Technical Guidance

- Robert Spotnitz (Battery Design, LLC)