

Battery Choices for Different Plug-in HEV Configurations

Plug-in HEV Forum and Technical Roundtable

South Coast Air Quality Management District

Diamond Bar, CA

July 12, 2006

Ahmad Pesaran, Ph.D.

National Renewable Energy Laboratory

With support from
FreedomCAR and Vehicle Technologies Program
Office of Energy Efficiency and Renewable Energy
U.S. Department of Energy

NREL's Plug-in HEV R&D Activities

- Battery Level
 - R&D support to developers
 - Testing and evaluation – Sprinter PHEV testing
 - Thermal characterization and design
 - Supporting requirement analysis and development
- Vehicle Level
 - Real-world PHEV simulations - fuel economy and recharging
 - Support development of test procedures for PHEVs and MPG reporting
 - Evaluation of alternative PHEV design strategies
 - » all-electric vs. blended operation
 - PHEV design cost-benefit analysis
- Utility Level
 - Assessment of PHEV impacts on utilities
 - Exploring synergies between PHEVs and wind power
 - V2G opportunities for PHEVs in regulation services
- National Level
 - Benefits assessment - oil use and emissions
 - Renewable community – linking PHEV to renewable
- Analysis support to DOE, OEMs, and others
 - Working to identify and overcome barriers to PHEV adoption



Secretary of Energy visiting NREL on 7/7/06 for ribbon cutting of the new S&T Facility and then discussing plug-in hybrids with EnergyCS & Hymotion

Topics of the Presentation

- Battery Technologies for PHEVs
 - State-of-the-art
 - Advances
- Impact of Vehicle Attributes on Battery
 - EV Range
 - System Architecture
 - Driving cycles and profiles
- Concluding Remarks and a Few Thoughts

Key Messages

- There is a broad spectrum of HEV-PHEV designs leading to different battery requirements.
- Batteries are available that could meet the energy and power demands for PHEVs, but cost and limited cycle/calendar life are major barriers for affordable PHEV introduction.
 - NiMH could do the job
 - Li-ion are potentially best candidates
 - All Li-ions are not “created equal”
- There are emission benefits with PHEVs, but the difference between pure EV range and blended EV range impacts may need to be understood
- PHEVs are the most cost-effective choice in a scenario of projected (low) battery costs and high fuel costs.

Batteries in Current PHEVs

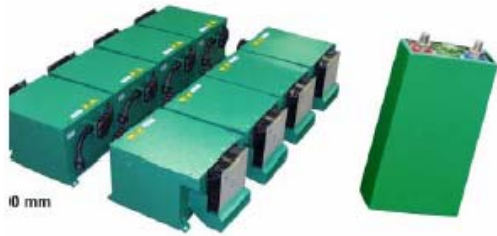

Varta

NiMH



Electro Energy Inc.



Johnson Controls/SAFT

**Co/Ni based
Li-Ion**

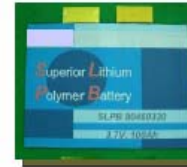

Kokam



Valence Technology



**Iron phosphate
based Li-Ion**



A123 Systems

High Power Battery and Ultracapacitor Characteristics for Hybrid Vehicles

Parameter	VRLA	NiMH	Li Ion	Ultracap
Cell configuration	Parallel plates; spirally wound cylindrical	Spirally wound cylindrical; parallel plates	Spirally wound cylindrical & elliptic	Spirally wound cylindrical & elliptic
Nominal cell voltage (V)	2	1.2	3.6	1.8
Battery electrolyte	Acid	Alkaline	Organic	Organic
Specific energy, Wh/kg	25	40	60 to 80	5
Battery/Module specific power, 10 sec, W/kg				
23°C, 50% SOC	400	1300	3000	>3000
-20°C, 50% SOC	250	250	400	>500
Charge acceptance, 10 sec. W/kg				
23°C, 50% SOC	200	1200	2000	>3000
2010 Projected Cost >100,000 per year				
\$/kWh, Module	100.00	500.00	700.00	20,000.00
\$/kWh, Full pack	140	600	1100	25000
\$/kW, pack	9.00	18.00	22.00	40.00
Energy efficiency	Good	Moderate	Good	Very Good
Thermal managements requirements	Moderate	High	Moderate	Light
Electrical control	Light	Light	Tight	Tight

Qualitative Comparison of Large-Format Battery Technologies for PHEVs

Attribute	Lead Acid	NiMH	Li-Ion
Weight (kg)	Poor	Fair	Good
Volume (lit)	Poor	Good	Good
Capacity/Energy (kWh)	Poor	Fair	Good
Discharge Power (kW)	Good	Fair	Good
Regen Power (kW)	Poor	Fair	Good
Cold-Temperature (kWh & kW)	Good	Fair	Poor
Shallow Cycle Life (number)	Fair	Good	Good
Deep Cycle Life (number)	Poor	Good	Fair
Calendar Life (years)	Poor	Fair	Fair
Cost (\$/kW or \$/kWh)	Good	Poor	Poor
Safety- Abuse Tolerance	Good	Good	Fair
Maturity - Technology	Good	Good	Fair
Maturity - Manufacturing	Good	Fair	Poor

Key
(relative to
each other)

Poor

Fair

Good

NiMH has Matured in Power and Energy

Specific energy ranging from 45 Wh/kg to 80 Wh/kg depending on the power capability.



● Ovonic

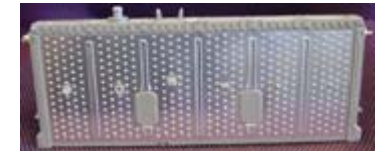

◆ Panasonic EV

EV-95



95 Ah EV module used in Toyota RAV 4

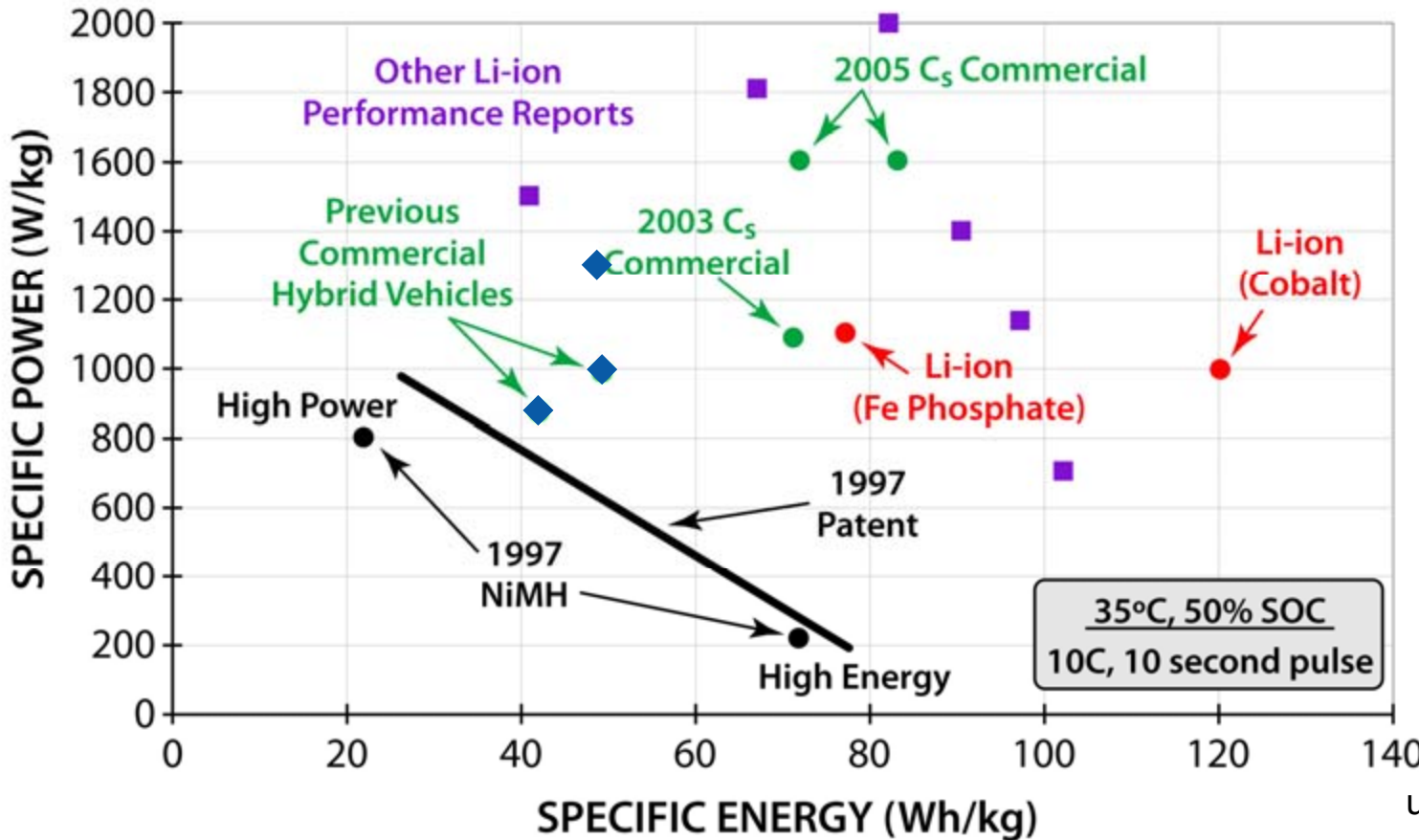

Source: Reproduced from A. Fetcenko (Ovonic Battery Company) from the 23rd International Battery Seminar & Exhibit, March 13-16, Ft. Lauderdale, FL.

NiMH batteries are forecasted to dominate the HEV market for a while

Panasonic



6.5 Ah Battery for Toyota

Sanyo



6.5 Ah HEV cells in Ford Escape HEV

Source: Sanyo website news

Cobasys



EV module (left) and 42V HEV batteries

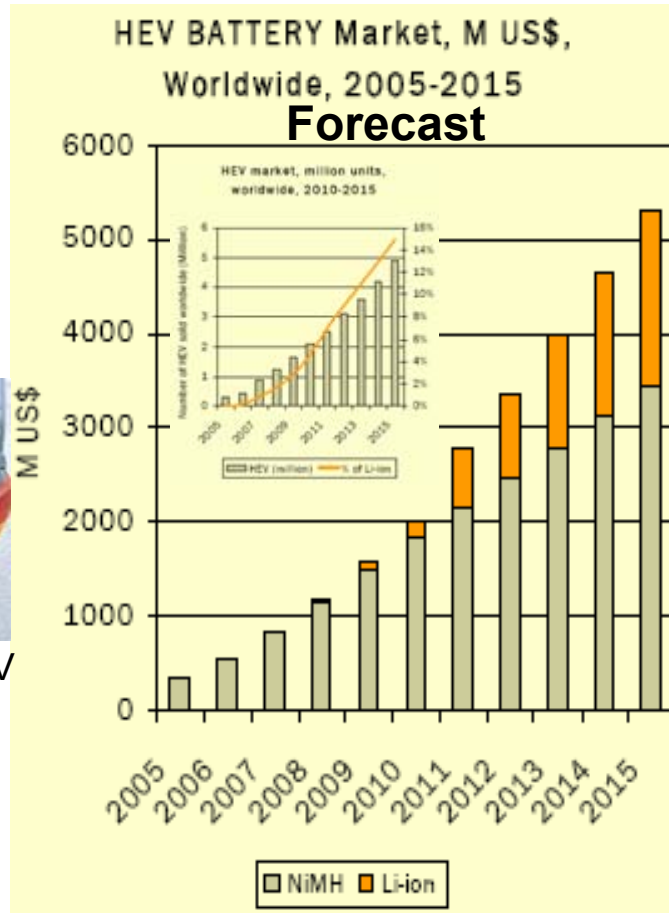

Source: C. Pillot (Avicenne) from the 23rd International Battery Seminar & Exhibit, March 13-16, Ft. Lauderdale, FL.

Electro Energy



Pack with bipolar Cells/Modules



Bipolar pack in a Plug-In Prius

Source: Images provided by James Landi of Electro Energy Inc.

Li Ion Technology – Diverse Chemistry & Opportunity

Charging

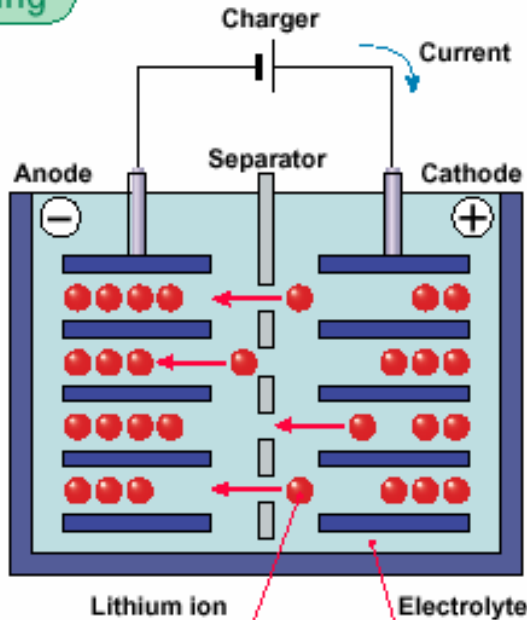

Discharging

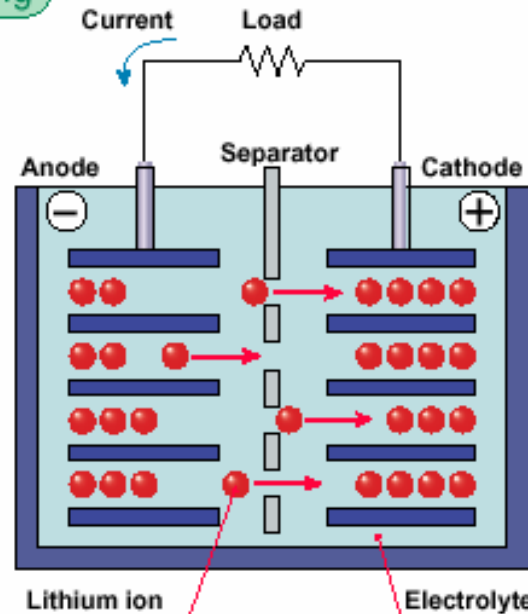

Voltage ~3.2-3.8 V
 Cycle life ~1000-3000
 Wh/kg >150
 Wh/l >400
 Discharge -30 to 60°C
 Shelf life <10%/year

Many anodes are possible

Carbon/Graphite
 Titanate ($\text{Li}_4\text{Ti}_5\text{O}_{12}$)
 Titanium oxide based
 Thin Oxide based
 Tungsten oxide

Many electrolytes are possible

LiPF_6 based
 LiBF_4 based
 Various solid electrolytes
 Polymer electrolytes

Many cathodes are possible

Cobalt oxide
 Manganese oxide
 Mixed oxides with Nickel
 Iron phosphate
 Vanadium oxide based

Source: Robert M. Spotnitz, Battery Design LLC, "Advanced EV and HEV Batteries," 2005 IEEE Vehicle Power and

11 Propulsion Conference, September 7-9, 2005, IIT, Chicago, IL

Characteristics of Cathode Materials

Theoretical values for a battery system relative to graphite anode and LiPF₆ electrolyte

Material	Δx	mAh/g	avg V	Wh/kg	Wh/l
LiCoO ₂	0.55	151	4.00	602	3073
LiNi _{0.8} Co _{0.15} Al _{0.05} O ₂	0.7	195	3.80	742	3784
LiMn ₂ O ₄	0.8	119	4.05	480	2065
LiMn _{1/3} Co _{1/3} Ni _{1/3} O ₂	0.55	153	3.85	588	2912
LiFePO ₄ *	0.95	161	3.40	549	1976

*Typically diluted with 10% carbon for electronic conductivity

Lower potential can provide greater stability in electrolyte

Cobalt oxide most widely used in consumer cells but recently too expensive

LiMn_{1/3}Co_{1/3}Ni_{1/3}O₂ newer than LiNiCoO₂

Mn₂O₄ around for many years – not competitive for consumer – good for high power

LiFePO₄ – very new – too low energy density for consumer electronics

- safe on overcharge but need electronics to prevent low voltage

- may require larger number of cells due to lower voltage

Nano-materials in Li-Ion Batteries Improve Performance & Life

- Easier diffusion of Li-ion into and out of the host
 - High specific capacity at high rate
- Increased electrode surface area and thus higher rates
- Stable 3 dimensional host materials
- Small dimensional change as Li-ions are cycled in and out
 - Improved cycling life due to less structural change
 - Low irreversible capacity loss
- Exhibit of both faradaic and non-faradaic capacity
 - Higher capacity retention
- Enabling new materials

Source: Expects A. Singhal (NEI Corporation) and E. House (Altair Nanotechnologies) from the 23rd International Battery Seminar & Exhibit, March 13-16, Ft. Lauderdale, FL.

Many Oxide Based Li-Ion Batteries are Available

- Johnson Control
- Saft
- LG Chem
- Kokam
- Sony
- Sanyo
- Samsung
- Panasonic
- Electrovaya
- NEC Lamilion Energy
- Nissan
- Lishen
- Pionics
- SK Corp
- GS Yuasa
- Altair Nanotechnologies

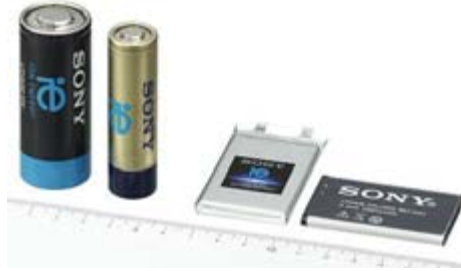

Lithium Iron Phosphate (LiFePO_4) Cathodes

- + High stability and non-toxic
 - + Good specific capacity
 - + Flat voltage profile
 - + Cost effective (less expensive cathode)
 - + Improved safety
 - Lower voltage than other cathodes
 - Poor Li diffusion ($D_{\text{Li}} \sim 10^{-13} \text{ cm}^2/\text{Sec}$)
 - Poor electronic conductivity ($\sim 10^{-8} \text{ S/cm}$)
- Approach many use to overcome poor characteristics
 - Use nano LiFePO_4 – carbon composite
 - Use larger number of cells
 - Nano structured materials

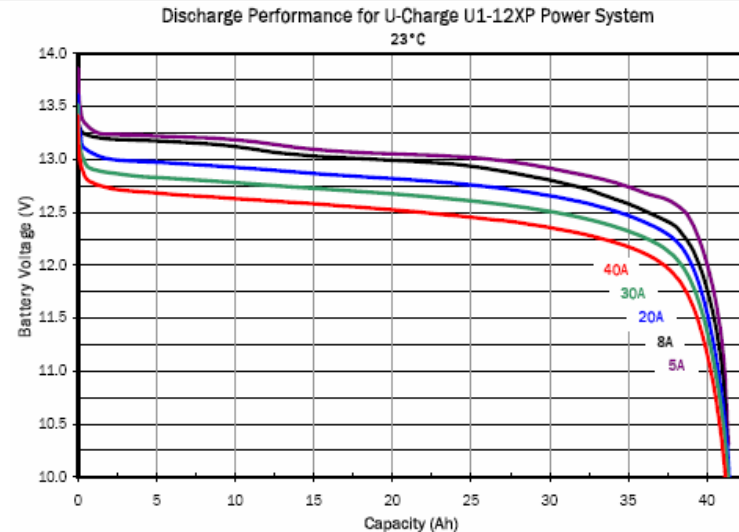

Source: On line brochures from Valence Technology, <http://www.valence.com/ucharge.asp>

Source: Various papers from the 23rd International Battery Seminar & Exhibit, March 13-16, Ft. Lauderdale, FL.

Improvements in Iron Phosphate Li-Ion Batteries

Valence Technology 18650 Cells

100 Wh/kg in cell 84 Wh/kg in U Charge module



The battery with standard lead acid battery form factor includes a battery management system.

Specifications		U1-12XP	U24-12XP
Voltage		12.8 V	12.8 V
Capacity (C/5)		40 Ah	100 Ah
Specific energy		84 Wh/kg	82 Wh/kg
Energy density		110 Wh/l	126 Wh/l
Standard Discharge	Max. cont. current	80 A	150 A
	Max. 30 sec. pulse	120 A	300 A
	Cut-off voltage	10 V	10 V

Source: On line brochures from Valence Technology, <http://www.valence.com/ucharge.asp>

Power Density (<3Ah cy cells)	Weight to discharge @1500W	Safety	Life at 100% DoD 1C rate	Environmental
3600 W/Kg	0.9 lbs	✓	~7000	✓

Based on: Novel nano scale doped phosphate active materials (pat. pending)
Low impedance cell design and electrolyte (pat. pending)



**A123 Systems
with 26650 Cells
100 Wh/kg**

Source: Andrew Chu (A123 Systems) from the 23rd International Battery Seminar & Exhibit, March 13-16, Ft. Lauderdale, FL.

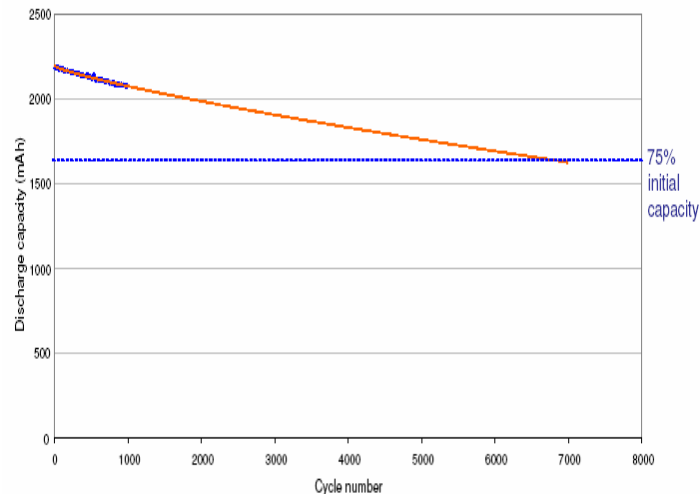

100%DOD 1C charge, 1C discharge cycling data.
Using first 1000 cycles, extrapolated cycle life: ~7000 cycles.

Improving Li-Ion Batteries with Titanate Anode

Characteristic	Traditional Li Ion Batteries	Li Ion Batteries Using Altairnano materials
Electrode Materials		
Anode	Graphite	Lithium titanate spinel
Cathode	Cobaltate	Nano-Structured oxides
Performance		
Charge rate	1/2 C	20 C and greater
Discharge rate	4 C	40 C and greater
Cycle life	300-500 cycles	9,000 cycles (full DOD)
Calendar life	2-3 years	10-15 years

Long Life, POWER Lithium Ion Batteries

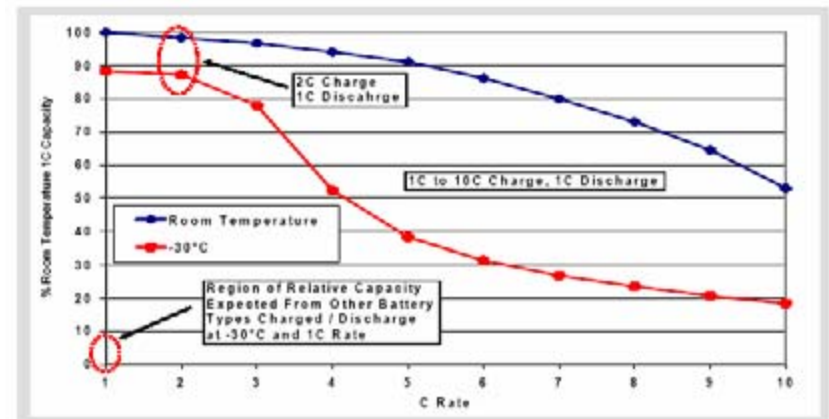

~90% SOC of RT Cell at -30°C and 1-2C Charge Rate!

Altaire Nanotechnologies Inc.

- Improved low temperature performance
- Faster charge acceptance
- Longer cycle life
- 80-100 Wh/kg
- 2000-4000 W/kg

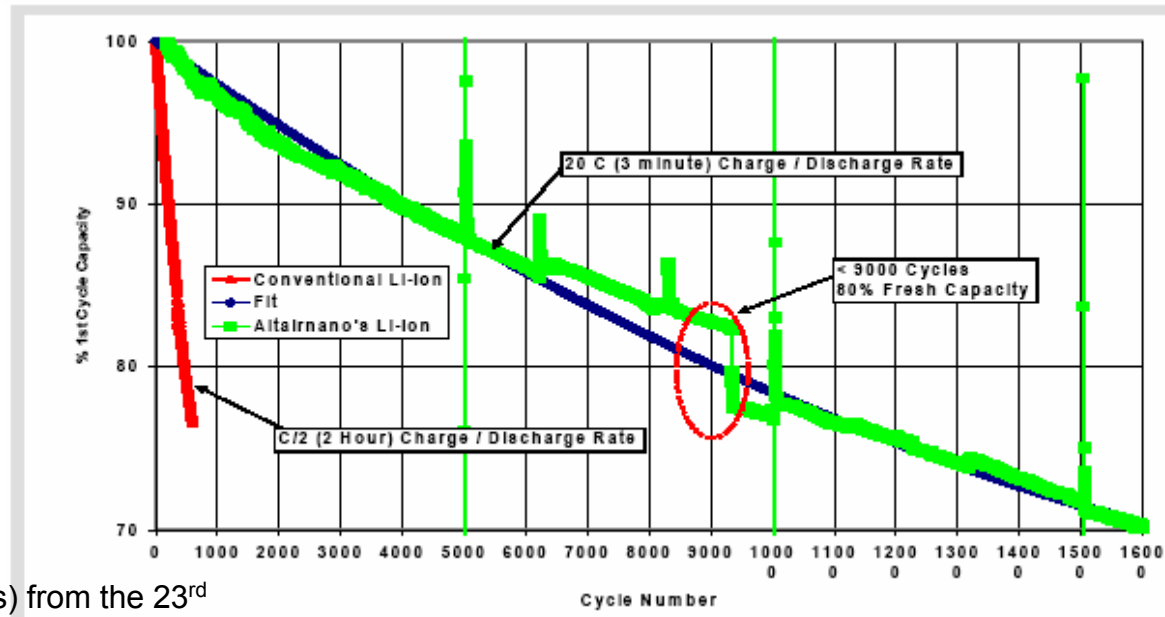

Source: E. House (Altair Nanotechnologies) from the 23rd International Battery Seminar & Exhibit, March 13-16, Ft. Lauderdale, FL.

PHEV Battery Options

Need for higher energy than HEVs, so P/E lower

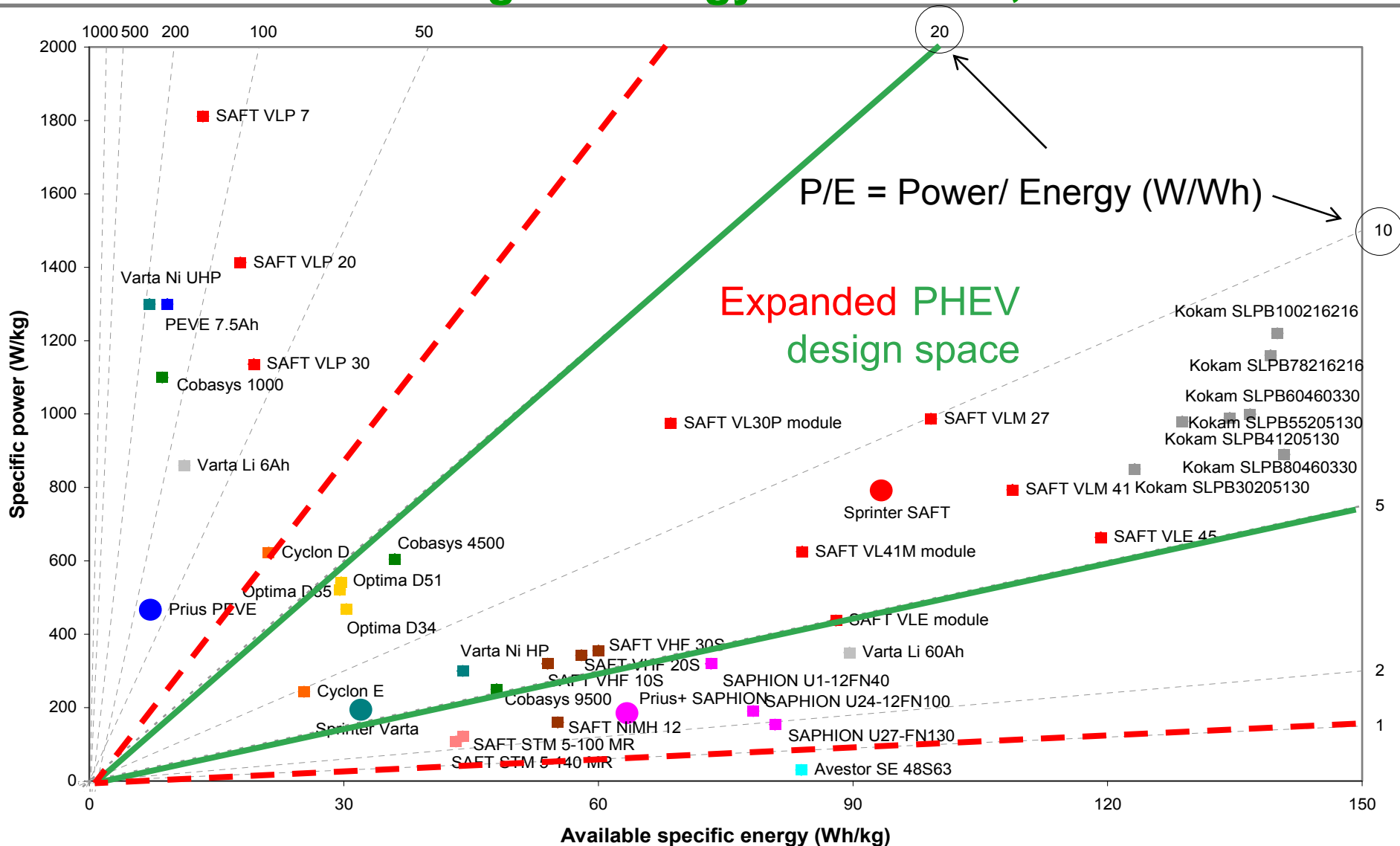

Source: Tony Markel and Andrew Simpson, Milestone Report, National Renewable Energy Laboratory, Golden, CO, September 2005.

Battery Cycle Life Depends on State of Charge Swing

- PHEV battery likely to deep-cycle each day driven: 15 yrs equates to 4000-5000 deep cycles
- Also need to consider combination of high and low frequency cycling

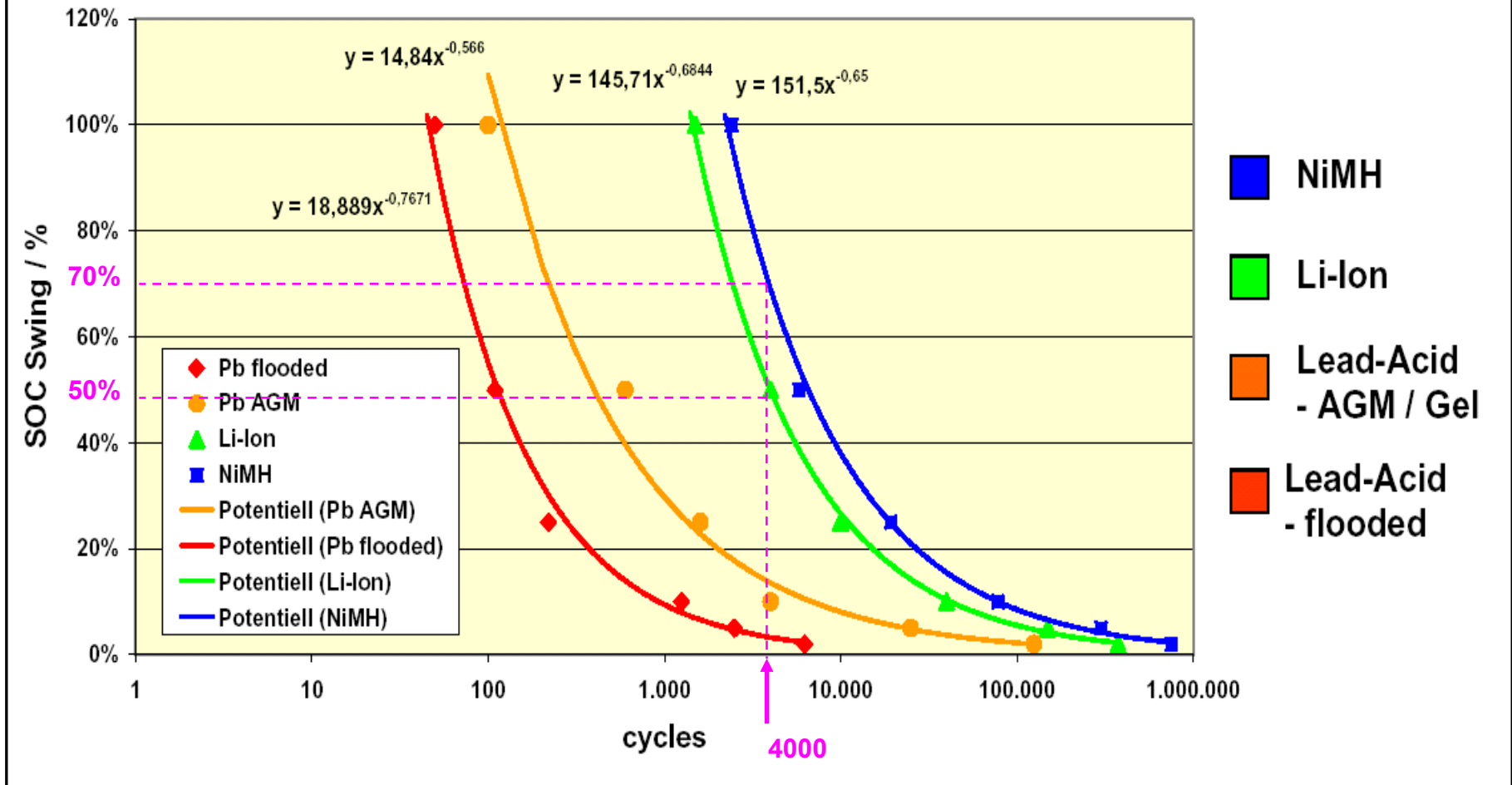

Source: Christian Rosenkranz (Johnson Controls) at EVS 20, Long Beach, CA, November 15-19, 2003

Summary: Exciting Times for Li-Ion Batteries

- New Cathodes
 - Lower cost
 - Higher power
 - Better safety
 - Improved life
- New Anodes
 - Faster charge rate
 - Improved life
- New Electrolyte
 - Improved safety
 - Improved low temperature performance
- New Separator
 - Lower cost
 - Improved safety

Battery Definition as Key Input to Simulation

Input parameters that define the battery in BLUE

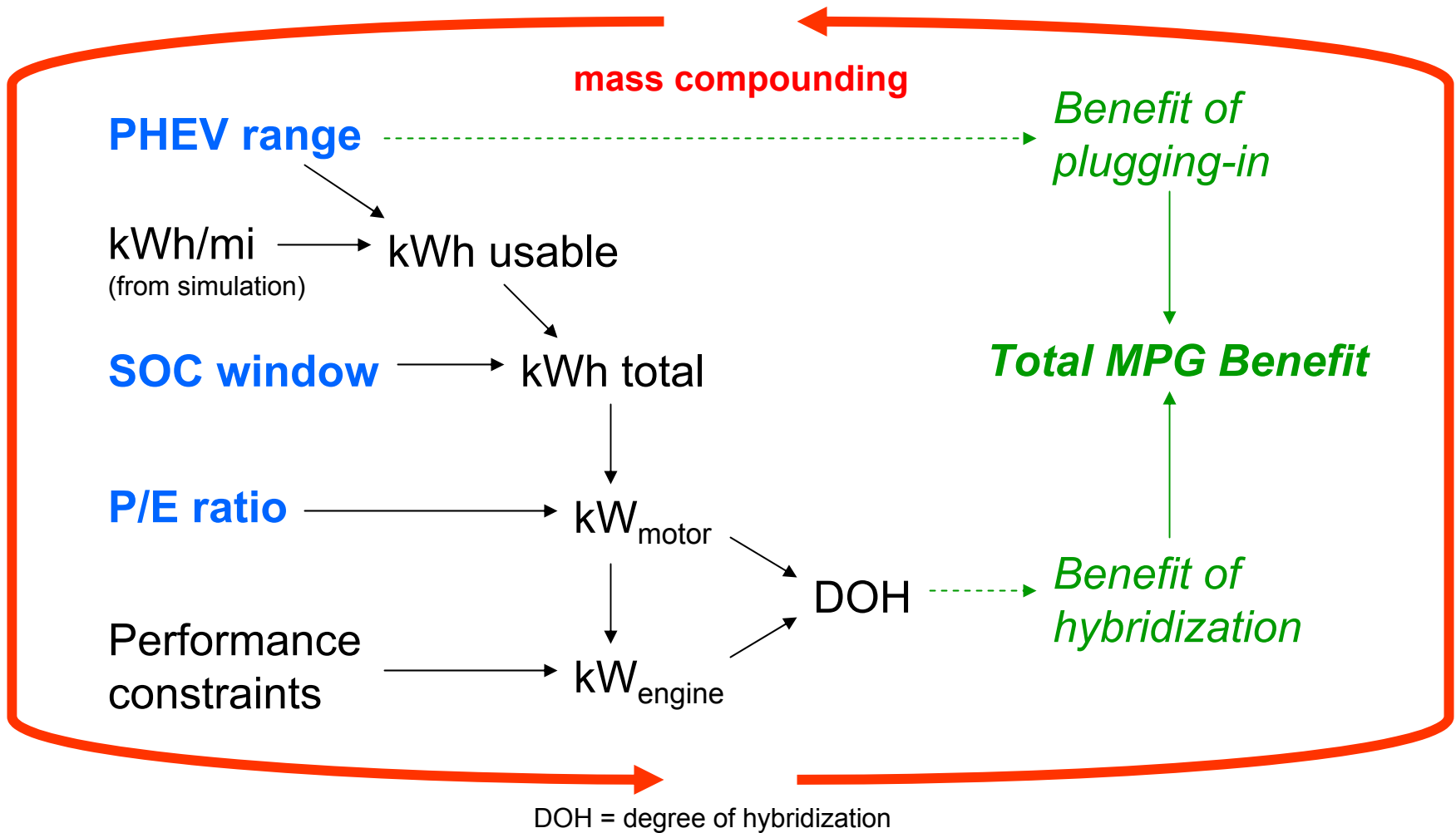

Source: Tony Markel and Andrew Simpson, Milestone Report, National Renewable Energy Laboratory, Golden, CO, September 2005.

Alternative PHEV Design Strategies: All-Electric vs Blended

- Engine turns on when battery reaches low state of charge
- Requires high power battery and motor

All-Electric (Pure EV or ZEV)

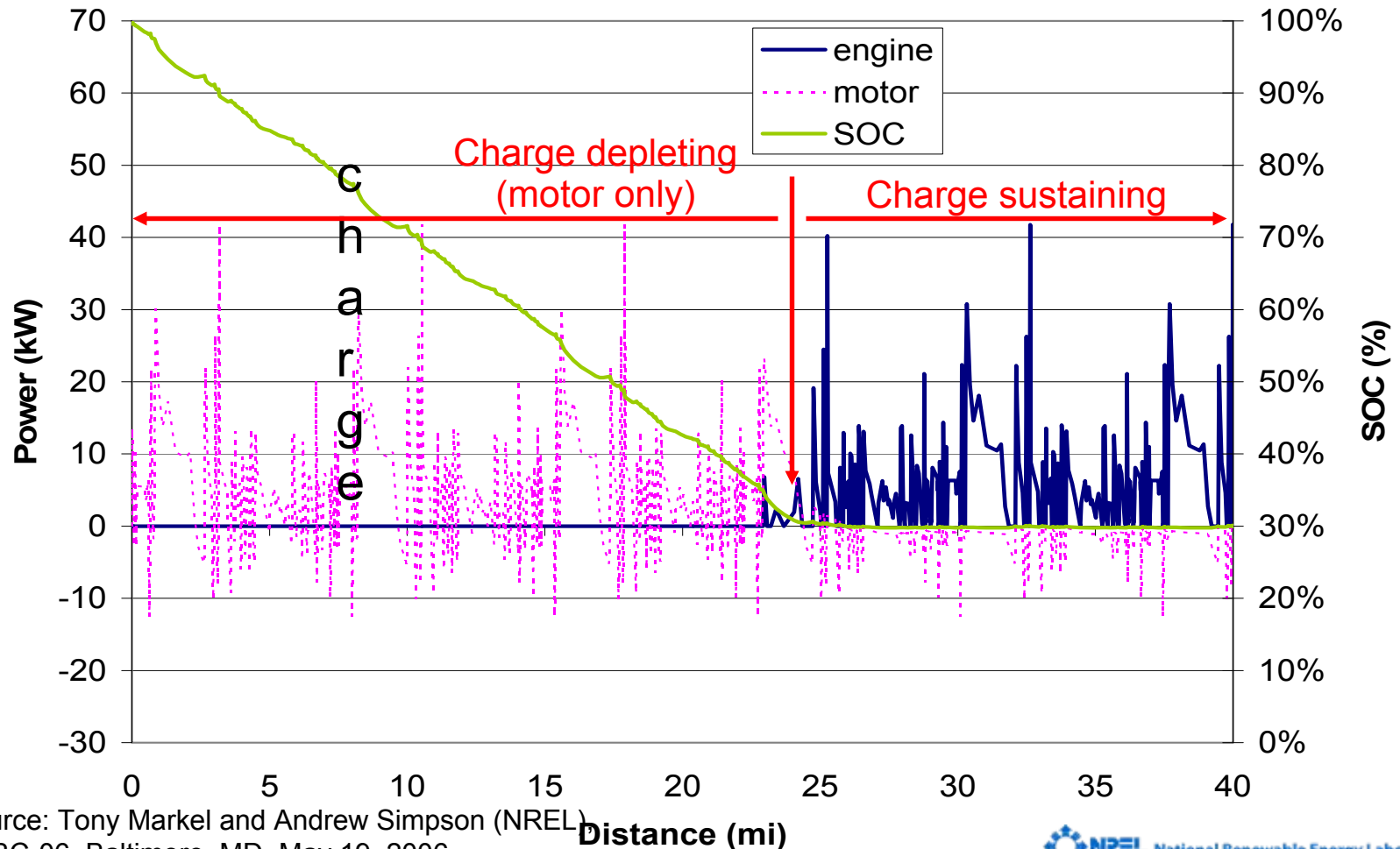

Source: Tony Markel and Andrew Simpson (NREL)

AABC-06, Baltimore, MD, May 19, 2006

Alternative PHEV Design Strategies: All-Electric vs Blended

- Engine turns on when power exceeds battery power capability
- Engine only provides load that exceeds battery power capability

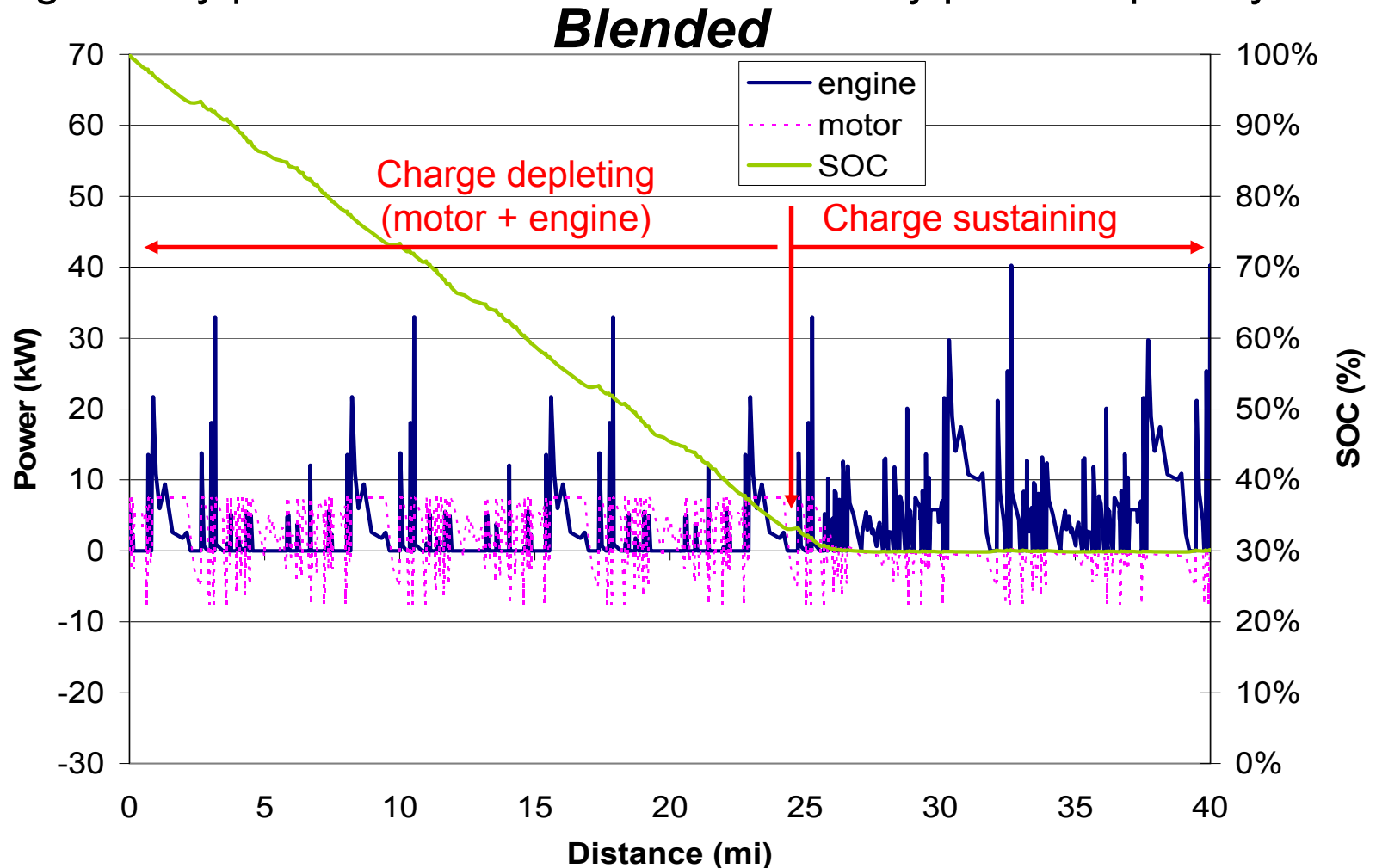

Blended vs. AER Consumption Tradeoff

PHEV20 on LA92

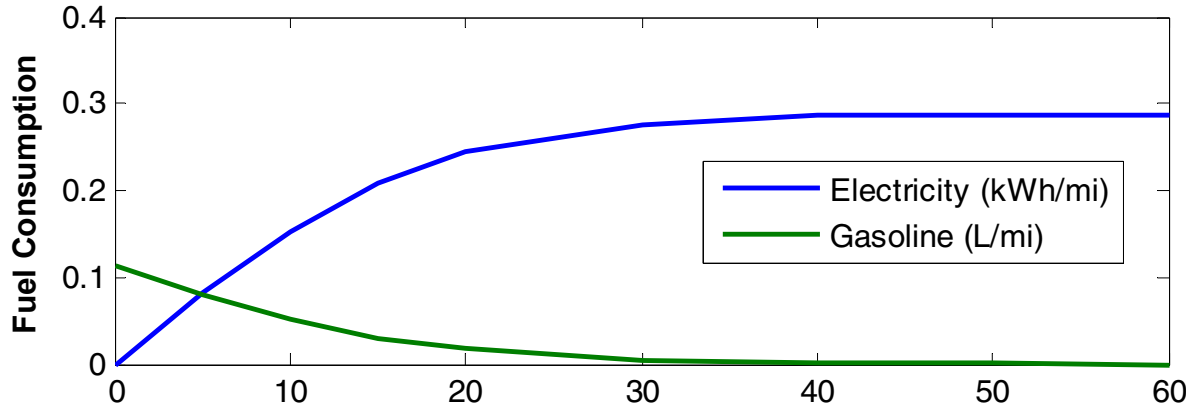

- Reducing ESS power should reduce cost, mass, volume
- 50% reduction in power still provides almost all of the fuel consumption benefit

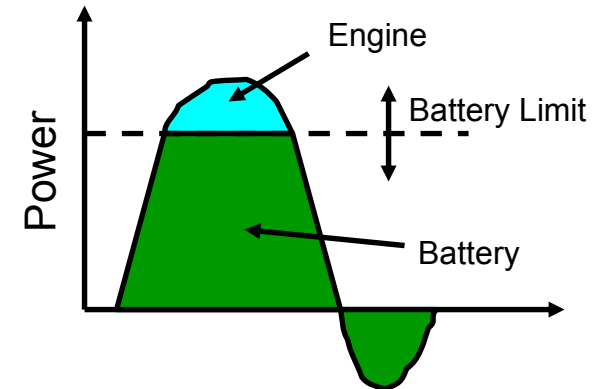
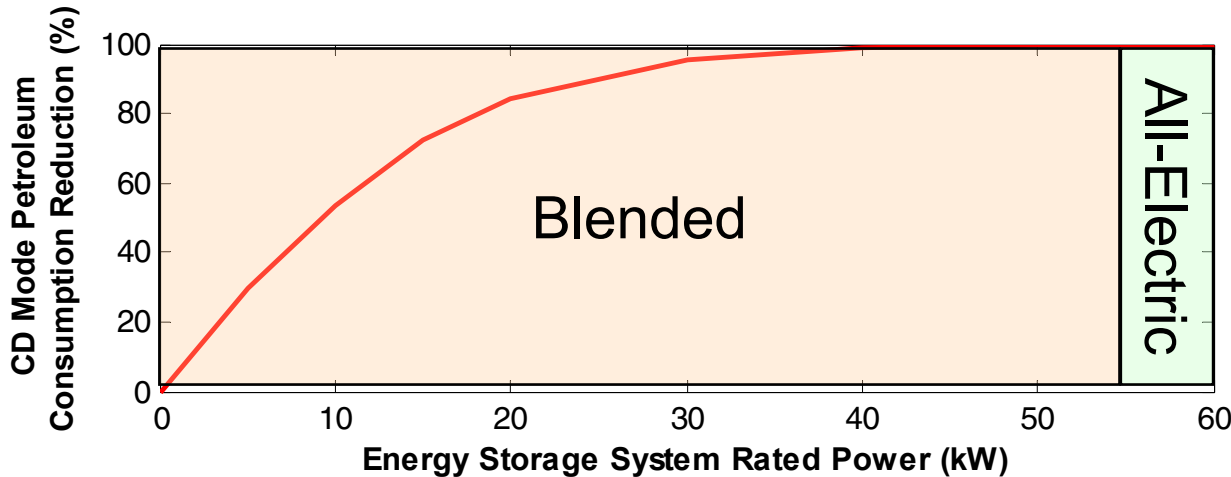

* CD = Charge Depleting

Source: Tony Markel and Andrew Simpson (NREL), AABC-06, Baltimore, MD, May 19, 2006

PHEV Battery Sizing Alternatives

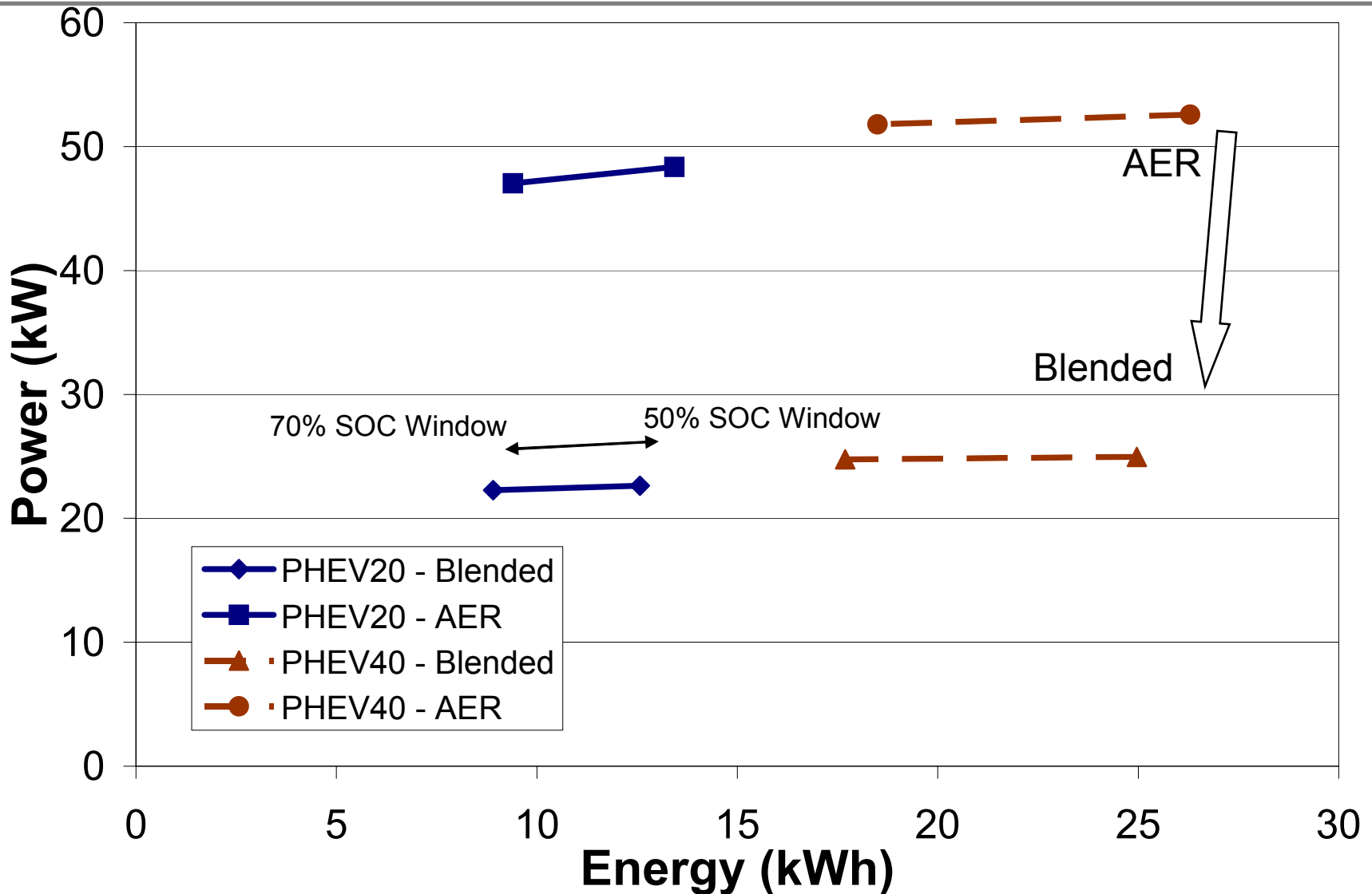

Source: Tony Markel and Andrew Simpson (NREL), AABC-06, Baltimore, MD, May 19, 2006

Battery Cost Model based on P/E Ratio

Lower power to energy ratio leads to lighter, smaller, and less expensive energy storage system.

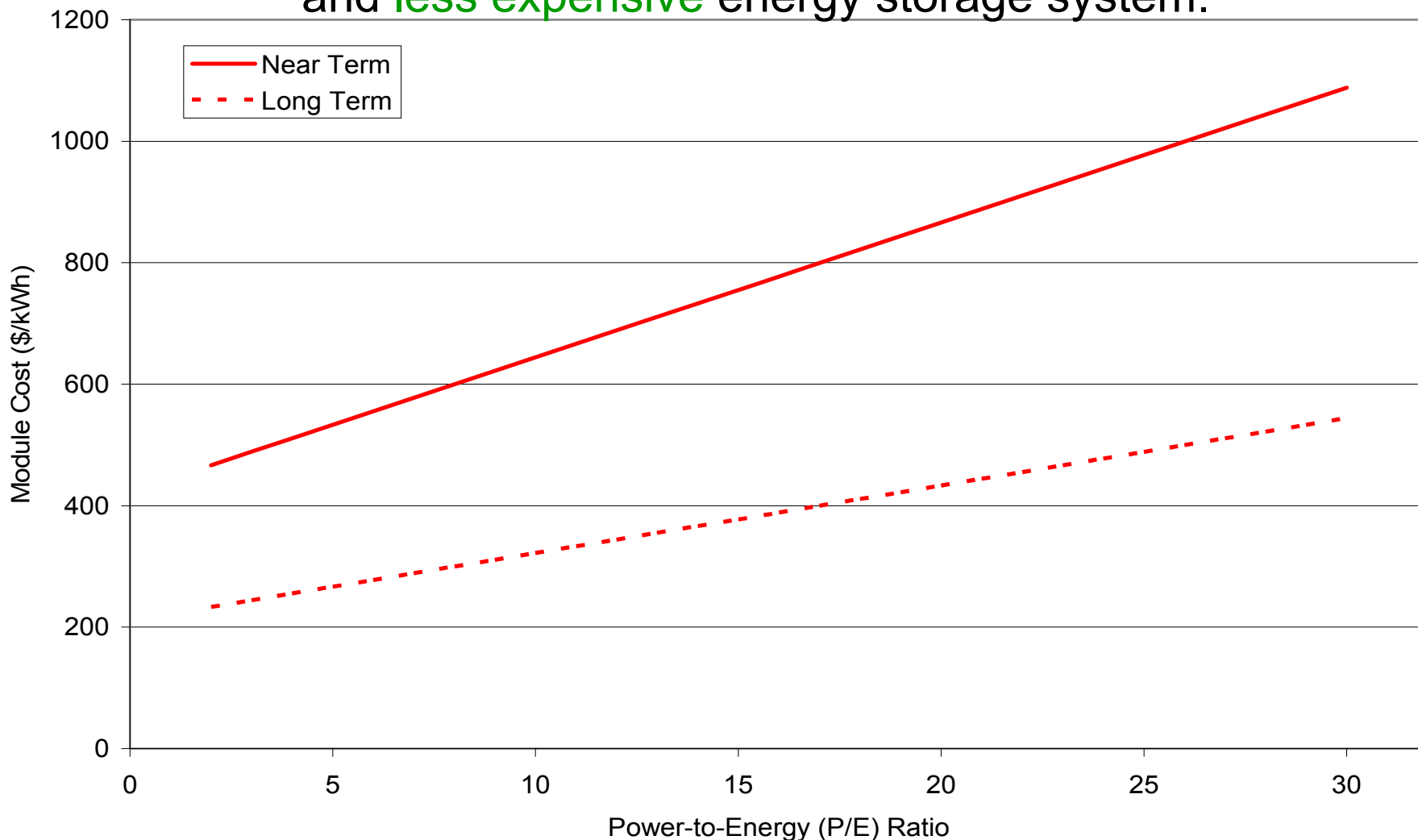

Battery Model (cont.) – SOC Window

Battery SOC Operating Window vs. Specified All-Electric Range

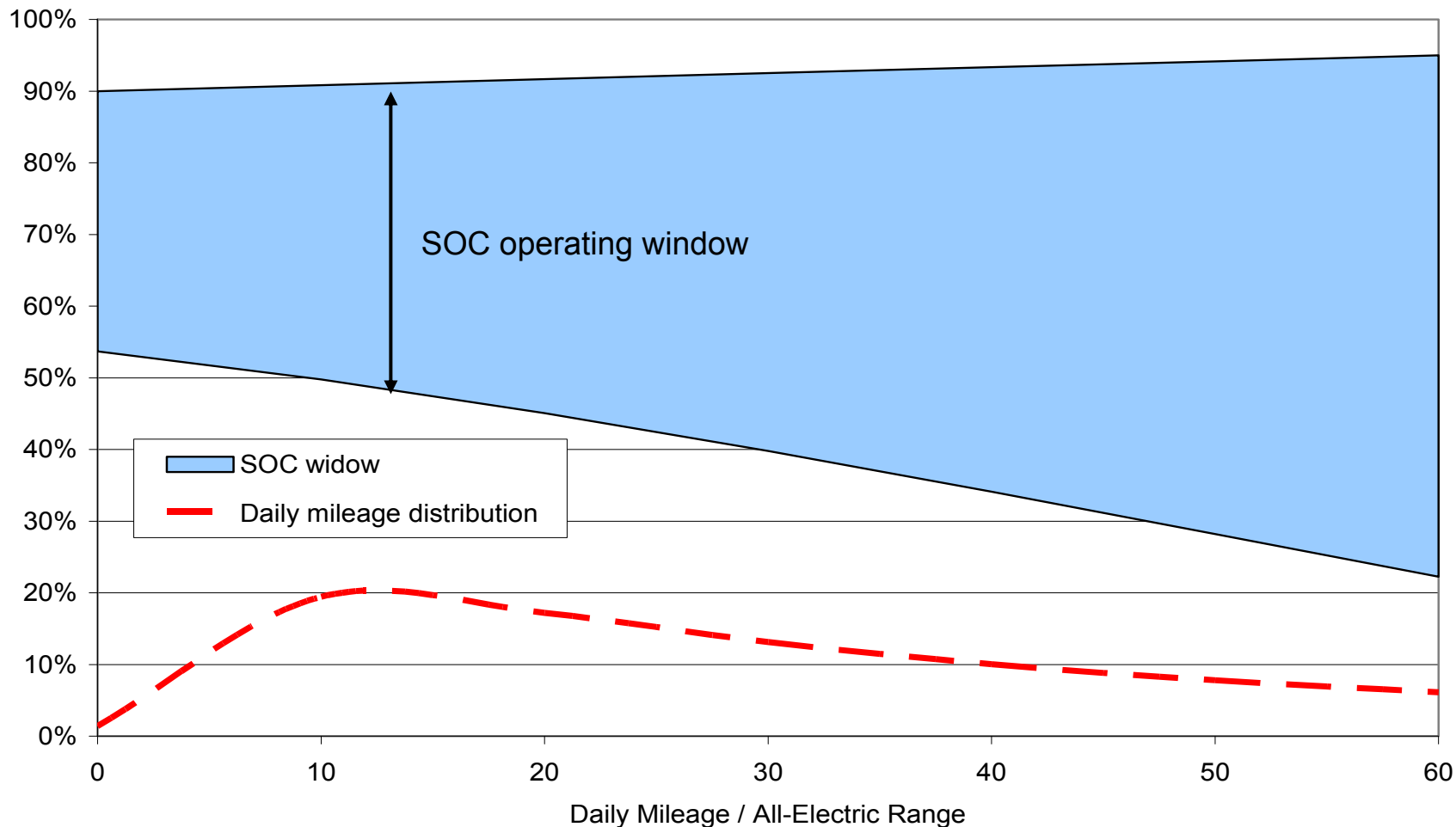

Source: Andrew Simpson (NREL), Presented to FreedomCAR Vehicle System Analysis Team, March 1 2006

Real Driving Survey Data

- Provides valuable insight into travel behavior
- GPS augmented surveys supply details needed for vehicle simulation

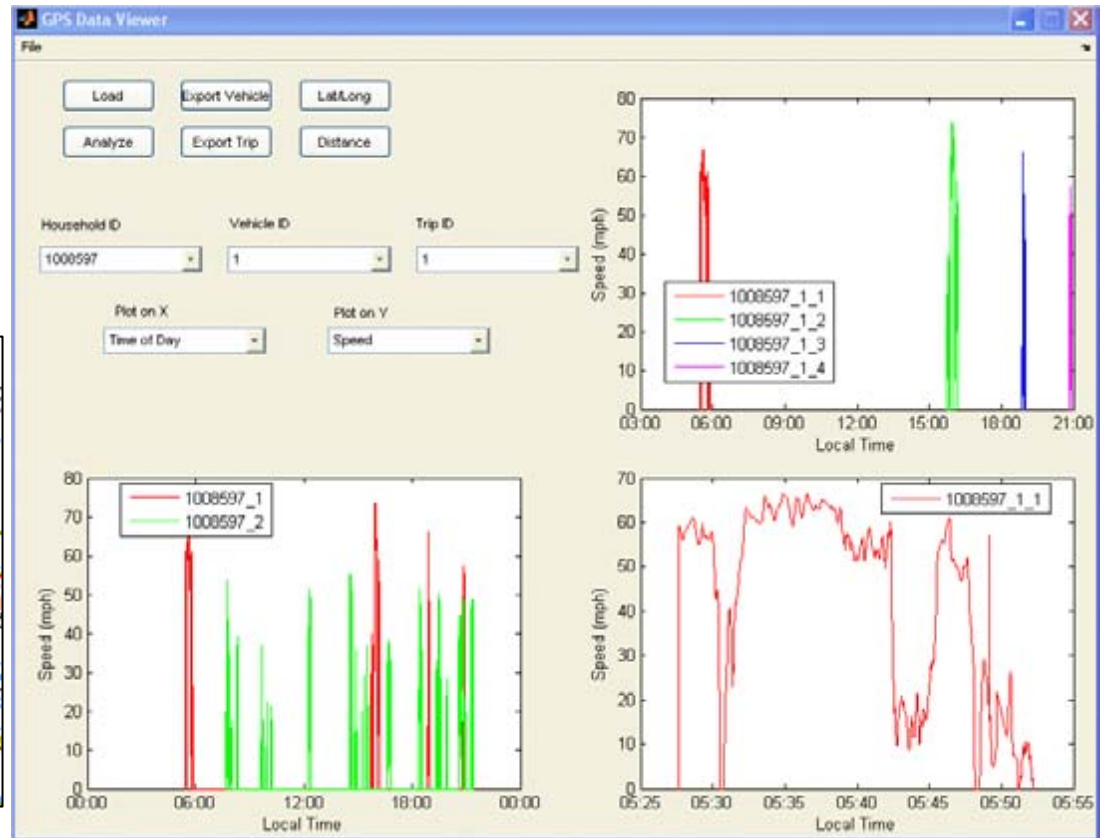
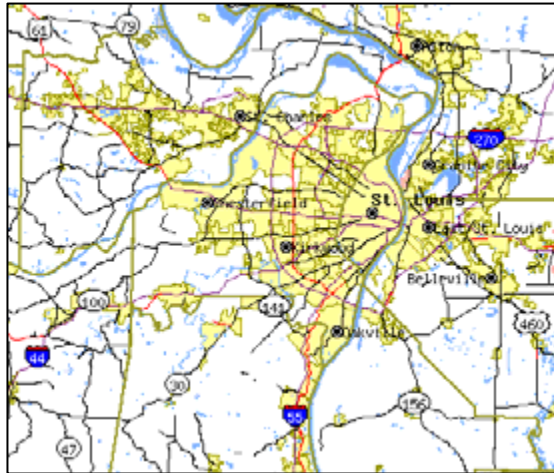
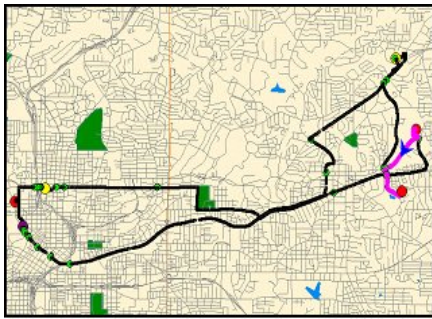

St. Louis Travel Data Analysis

Daily Driving Distance Similar to 1995 NPTS Data

St. Louis HHTS Data

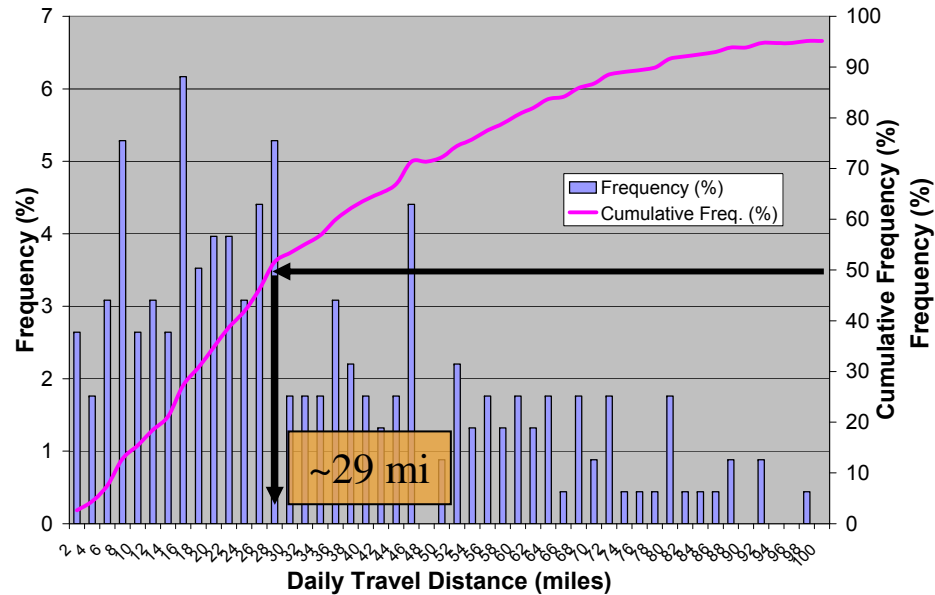

1995 NPTS Data

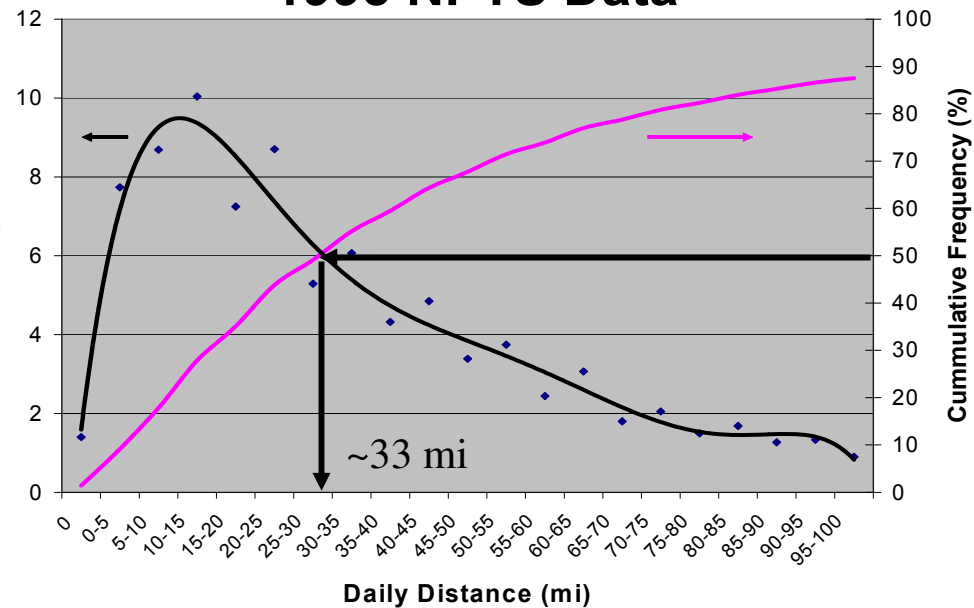

- St. Louis data set includes 227 vehicles from 147 households
- Complete second by second driving profile for one day
- 8650 miles of travel
- St. Louis data set is a small sample of real data
- NPTS data is generated from mileage estimates

Source: Tony Markel, Jeff Gondor, and Andrew Simpson (NREL), Presented to FreedomCAR Vehicle System Analysis Team, June 14 2006

PHEVs Reduce Fuel Consumption By >50% On Real-World Driving Cycles

227 vehicles from St. Louis each modeled as a conventional, hybrid and PHEV

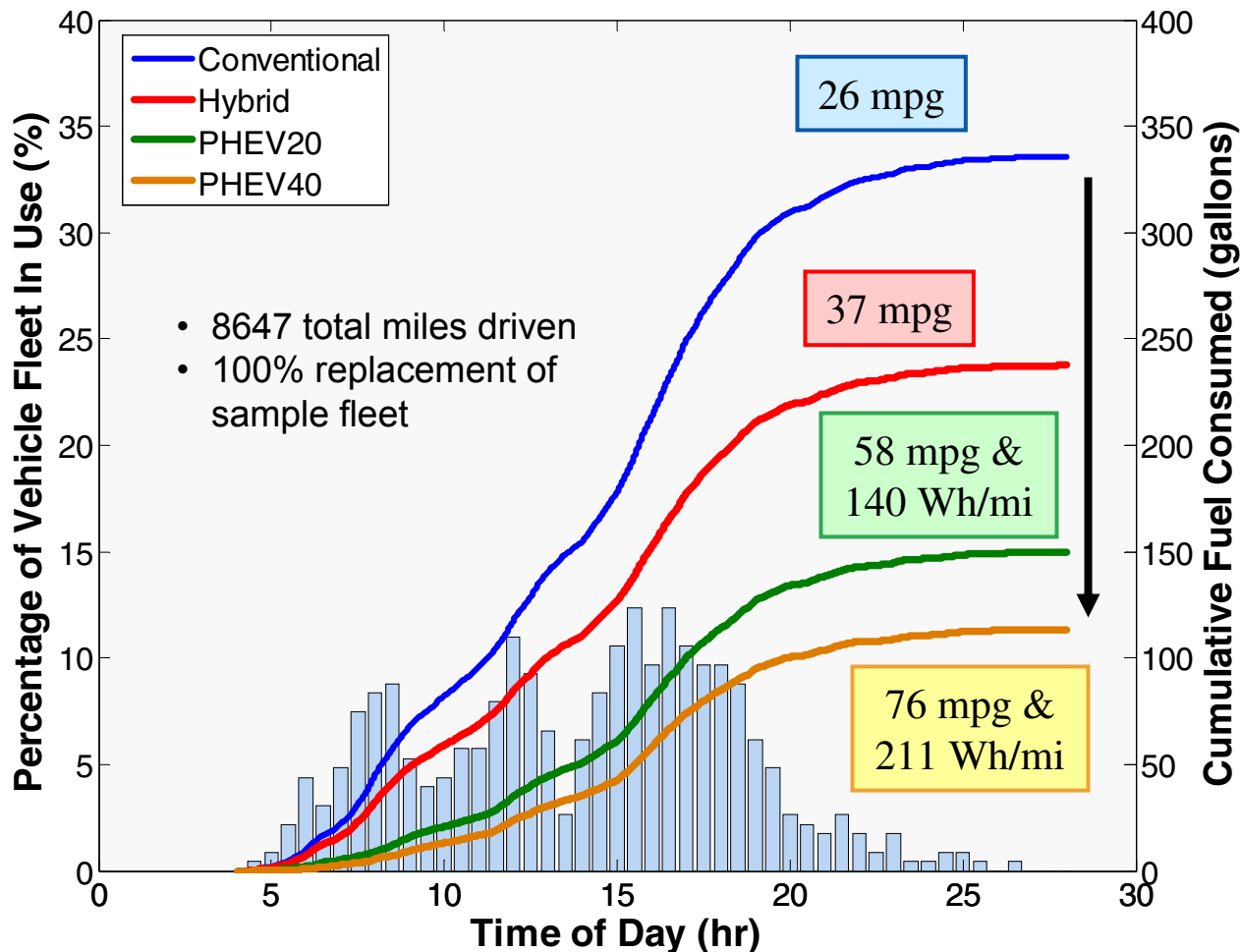

	Average Daily Costs		
	Gas.	Elec.	¢/mi
CV	\$3.45	---	9.1
HEV	\$2.48	---	6.5
PHEV20	\$1.58	\$0.48	5.4
PHEV40	\$1.21	\$0.72	5.1

Assumes \$2.41/gal and 9¢/kWh

PHEVs:
>40% reduction in energy costs
>\$500 annual savings

Source: Tony Markel and Andrew Simpson (NREL), AABC-06, Baltimore, MD, May 19, 2006

Fuel Economy and All Electric Range Comparison

- Difference between rated (EPA drive cycles) and Real median values are significant for the PHEVs
 - Consumers likely to observe fuel economy higher than rated value in typical driving
 - Vehicles designed with all electric range likely to operate in a blended mode to meet driver demands

	<i>Fuel Economy (mpg) **</i>		<i>All Electric Range (mi)</i>	
	Rated	Median	Rated	Median
Conventional	26	24.4	n/a	n/a
HEV	39.2	35.8	n/a	n/a
PHEV20	54	70.2	22.3	5.6
PHEV40	67.4	133.6	35.8	3.8

** Fuel economy values do not include electrical energy consumption

Concluding Remarks – Vehicle Simulations

- Simulations on sample real-world drive cycles suggests PHEV technology can dramatically reduce petroleum consumption.
- Benefits of a PHEV over a conventional vehicle or HEV are tied to travel behavior.
- A vehicle designed for all electric range in urban driving will likely provide only limited electric operation in real world applications
 - Still provides significant fuel displacement
- Plug-in hybrid technology can reduce petroleum consumption beyond that of HEV technology.

Concluding Remarks - Battery

- Batteries with low power to energy ratios would be needed for PHEVs
- Expansion of the energy storage system usable state of charge window while maintaining life will be critical for reducing system cost and volume
- A blended operating strategy as opposed to an all electric range focused strategy may provide some benefit in reducing cost and volume while maintaining petroleum consumption benefits
- The key remaining barriers to commercial PHEVs are battery life, packaging and cost.

Some Final Thoughts

- PHEVs reduce emissions and displace petroleum
 - Is there a need to require ZEV (pure EV) range?
 - Does blended EV range achieve both objectives?
- Does AER or ZEV need to be over a “standard” drive cycle or “real” drive cycles?
- DOE and others are focusing R&D to reduce battery cost and to improve performance and life.
- Incentives for PHEVs with larger EV range (larger battery pack) may be needed.
- Learning demonstrations are key in the short term – a good role for AQMD.

- DOE Program Support
 - Dave Howell
 - Tien Duong

- NREL Technical Support
 - Tony Markel
 - Andrew Simpson
 - Jeff Gonder