

Cold Climate Foundation Retrofit Energy Savings: The Simulated Energy and Experimental Hygrothermal Performance of Cold Climate Foundation Wall Insulation Retrofit Measures— Phase I, Energy Simulation

Louise F. Goldberg and Brianna Steigauf
NorthernSTAR

April 2013

NOTICE

This report was prepared as an account of work sponsored by an agency of the United States government. Neither the United States government nor any agency thereof, nor any of their employees, subcontractors, or affiliated partners makes any warranty, express or implied, or assumes any legal liability or responsibility for the accuracy, completeness, or usefulness of any information, apparatus, product, or process disclosed, or represents that its use would not infringe privately owned rights. Reference herein to any specific commercial product, process, or service by trade name, trademark, manufacturer, or otherwise does not necessarily constitute or imply its endorsement, recommendation, or favoring by the United States government or any agency thereof. The views and opinions of authors expressed herein do not necessarily state or reflect those of the United States government or any agency thereof.

Available electronically at <http://www.osti.gov/bridge>

Available for a processing fee to U.S. Department of Energy
and its contractors, in paper, from:

U.S. Department of Energy
Office of Scientific and Technical Information
P.O. Box 62
Oak Ridge, TN 37831-0062
phone: 865.576.8401
fax: 865.576.5728
email: <mailto:reports@adonis.osti.gov>

Available for sale to the public, in paper, from:

U.S. Department of Commerce
National Technical Information Service
5285 Port Royal Road
Springfield, VA 22161
phone: 800.553.6847
fax: 703.605.6900
email: orders@ntis.fedworld.gov
online ordering: <http://www.ntis.gov/ordering.htm>



**Cold Climate Foundation Retrofit Energy Savings:
The Simulated Energy and Experimental Hygrothermal
Performance of Cold Climate Foundation Wall Insulation Retrofit
Measures—Phase I, Energy Simulation**

Prepared for:

The National Renewable Energy Laboratory
On behalf of the U.S. Department of Energy's Building America Program
Office of Energy Efficiency and Renewable Energy
15013 Denver West Parkway
Golden, CO 80401
NREL Contract No. DE-AC36-08GO28308

Prepared by:

Louise F. Goldberg and Brianna Steigauf
NorthernSTAR Building America Partnership
2004 Folwell Avenue
Minneapolis, Minnesota 55108

NREL Technical Monitor: Stacy Rothgeb
Prepared under Subcontract No. KNDJ-0-40338-00

April 2013

Acknowledgments

This report was prepared for the U.S. Department of Energy Building America program. Funding for this work was provided by the National Renewable Energy Laboratory under contract KNDJ-0-40338-00. Additional funds were provided by the University of Minnesota and the Initiative for Renewable Energy and the Environment.

Contents

Acknowledgments	iv
List of Figures	vi
List of Tables	vii
Definitions	viii
Executive Summary	1
1 Introduction	2
1.1 Motivation.....	2
1.2 Implementation	3
2 Experimental Test System Selection	5
2.1 Introduction.....	5
2.2 Selected Experimental Wall Test Systems	5
2.3 Closing Comment	6
3 Energy Performance Modeling	8
3.1 Description of the BUFETS/EnergyPlus Simulation Methodology	8
3.2 Simulation Methodology Application.....	14
3.3 BUFETS Simulation Foundation Building Models	16
4 Model Comparison	21
4.1 Comparison With Experimental Data.....	22
4.2 Physical Consistency	25
5 Application to BEopt Building Models	34
5.1 Target Houses	34
5.2 Description of the Simulations.....	43
5.3 Full Basement Application for Janesville.....	45
5.4 Full Basement Application for Minneapolis.....	58
5.5 Full Basement Application for Bemidji.....	66
5.6 Crawlspace Application for Bemidji	73
5.7 Crawlspace Application for Minneapolis	76
5.8 Crawlspace Application for Janesville.....	79
6 Conclusions	82
References	85

List of Figures

Figure 1. BUFETS boundary conditions	9
Figure 2. Generalized application of the model to a full foundation.....	10
Figure 3. BUFETS/EnergyPlus/BEopt simulation methodology flowchart	11
Figure 4. Retrofit full basement foundation vertical section (without insulation).....	17
Figure 5. Retrofit crawlspace foundation vertical section (without insulation)	18
Figure 6. Retrofit foundation plan common to full basement and crawlspace sections (without insulation).....	18
Figure 7. Comparison building	22
Figure 8. Comparison against FTF data for interior R-10 XPS full-wall insulation	23
Figure 9. Comparison against FTF data for exterior R-10 XPS full-wall insulation.....	24
Figure 10. Absolute comparison building full basement foundation performance for Bemidji	27
Figure 11. Absolute comparison building full basement foundation performance for Minneapolis	28
Figure 12. Absolute comparison building full basement foundation performance for Janesville ...	29
Figure 13. Annual full basement heating and cooling load energy savings for Bemidji.....	30
Figure 14. Annual full basement heating and cooling load energy savings for Minneapolis	30
Figure 15. Annual full basement heating and cooling load energy savings for Janesville	31
Figure 16. Absolute comparison building crawlspace foundation performance	32
Figure 17. Annual crawlspace heating and cooling load energy savings	33
Figure 18. Full basement BEopt model house	37
Figure 19. Full basement BEopt model house specification.....	38
Figure 20. Crawlspace basement BEopt model house	39
Figure 21. Crawlspace BEopt model house specification	40
Figure 22. Full basement BEopt model house HVAC system configuration	42
Figure 23. Crawlspace BEopt model house HVAC system configuration	42
Figure 24. Absolute full basement energy consumption for Janesville.....	46
Figure 25. Full basement and living space temperature profiles for Janesville.....	48
Figure 26. Full basement and living space temperature profiles for Madison generated using the Janesville foundation library.....	50
Figure 27. Basement heating and cooling energy savings for Madison.....	52
Figure 28. Site energy savings produced by foundation wall insulation for Madison	53
Figure 29. Source energy savings produced by basement foundation wall insulation for Madison	54
Figure 30. Building energy distribution for a basement with BG only wall exposure for Madison..	55
Figure 31. Building energy distribution for a basement with AGBG wall exposure for Madison....	56
Figure 32. Basement heating and cooling energy savings for Minneapolis.....	59
Figure 33. Site energy savings produced by basement foundation wall insulation for Minneapolis	60
Figure 34. Source energy savings produced by basement foundation wall insulation for Minneapolis	61
Figure 35. Building energy distribution for a basement with BG only wall exposure for Minneapolis	62
Figure 36. Building energy distribution for a basement with AGBG wall exposure for Minneapolis	63
Figure 37. Basement heating and cooling energy for Minneapolis	64
Figure 38. Basement heating and cooling energy savings for Bemidji	67
Figure 39. Site energy savings produced by basement foundation wall insulation for Bemidji	68
Figure 40. Source energy savings produced by basement foundation wall insulation for Bemidji	69
Figure 41. Building energy distribution for a basement with BG only wall exposure for Bemidji ...	70
Figure 42. Building energy distribution for a basement with AGBG wall exposure for Bemidji	71
Figure 43. Basement heating and cooling energy for Bemidji	73
Figure 44. Living space heating and cooling energy savings from crawlspace wall insulation for Bemidji.....	73
Figure 45. Site energy savings from crawlspace wall insulation for Bemidji	74
Figure 46. Source energy savings from crawlspace wall insulation for Bemidji	74

Figure 47. Living space heating and cooling energy dependence on crawlspace wall insulation for Bemidji.....	75
Figure 48. Living space heating and cooling energy savings from crawlspace wall insulation for Minneapolis.....	76
Figure 49. Site energy savings from crawlspace wall insulation for Minneapolis.....	77
Figure 50. Source energy savings from crawlspace wall insulation for Minneapolis.....	77
Figure 51. Living space heating and cooling energy dependence on crawlspace wall insulation for Minneapolis.....	78
Figure 52. Living space heating and cooling energy savings from crawlspace wall insulation for Janesville.....	79
Figure 53. Site energy savings from crawlspace wall insulation for Janesville.....	80
Figure 54. Source energy savings from crawlspace wall insulation for Janesville.....	80
Figure 55. Living space heating and cooling energy dependence on crawlspace wall insulation for Janesville.....	81

Unless otherwise indicated, all figures were created by NorthernSTAR.

List of Tables

Table 1. Experimental Interior Retrofit Foundation Wall Systems.....	7
Table 2. BUFETS/EnergyPlus Foundation Section Coupling.....	11
Table 3. Full Basement Foundation Soil Saturation Ratios.....	19
Table 4. Crawlspace Foundation Soil Saturation Ratios for 42-in. Frost Footing.....	20
Table 5. Crawlspace Foundation Soil Saturation Ratios for 60-in. Frost Footing.....	20
Table 6. Minnesota Reference House Specification.....	35
Table 7. Simulation Matrix.....	44
Table 8. Two-Story 2009 Minnesota Energy Code Reference House With Full Basement for Bemidji Climate.....	86
Table 9. Two-Story 2009 Minnesota Energy Code Reference House With Full Basement for Minneapolis Climate.....	88
Table 10. Two-Story 2009 Minnesota Energy Code Reference House With Full Basement for Janesville Climate.....	90
Table 11. Two-Story 2009 Minnesota Energy Code Reference House With Full Basement for Madison Climate Using Janesville Foundation Performance Library.....	92
Table 12. Single-Story Bungalow in Compliance With 2009 Minnesota Energy Code With Passive Crawlspace for Bemidji.....	94
Table 13. Single-Story Bungalow in Compliance With 2009 Minnesota Energy Code With Passive Crawlspace for Minneapolis.....	95
Table 14. Single-Story Bungalow in Compliance With 2009 Minnesota Energy Code With Passive Crawlspace for Janesville.....	96

Unless otherwise indicated, all tables were created by NorthernSTAR.

Definitions

AG	Above grade
AGBG	Above and below grade
ANSI	American National Standards Institute
ASHRAE	American Society of Heating, Refrigerating and Air-Conditioning Engineers
BEM	BUFETS/EnergyPlus Model
BEopt	Building Energy Optimization
BEoptE+	Building Energy Optimization using EnergyPlus
BG	Below grade
BUFETS	Building Foundation Energy Transport Simulation
CRRF	Cloquet Residential Research Center
DOE	U.S. Department of Energy
FTF	Foundation Test Facility
HVAC	Heating, ventilation, and air conditioning
IECC	International Energy Conservation Code
IntExt	Interior+exterior
NREL	National Renewable Energy Laboratory
TMY	Typical Meteorological Year

Executive Summary

This project initiated an experimental and theoretical investigation of the energy and hygrothermal performance of retrofit foundation insulation systems in climate zones 6 and 7. To prepare for a planned experimental hygrothermal study, the authors identified a set of 10 likely interior foundation insulation retrofit systems. These include examples that are compliant with the Performance Option in the 2009 Minnesota Energy Code and noncompliant examples for control purposes.

A split simulation whole-building energy/three-dimensional earth contact model (termed the BUFETS/EnergyPlus Model or BEM) can model the full range of foundation systems in the target retrofit housing stock. This model was used to extensively evaluate the results produced by the NREL BEoptE+ tool. These foundation systems that include above-grade foundation walls, diabatic floors or slabs, and lookout or walkout walls could not be modeled in BEopt version 1.1 that was used in this project.

The simulation model was exercised for ideal and non-ideal building foundation models (from the BEM perspective); the constraints on—and limitations of—its applicability were demarcated clearly. When applied to an ideal building model in which the temporal foundation interior temperature profile is identical in both the whole-building and earth contact simulations, the model yields physically reasonable results that are validated by available foundation calorimetric energy balance experimental data. When applied to a non-ideal foundation model in which the foundation system interior temperatures are different, the model loses absolute accuracy but still generates energy savings data that are consistent with those produced by the ideal model application and by experimental data reported in the literature. The model has a strict stability requirement that the BUFETS foundation system interior temperature boundary condition temporal profile be greater than or equal to that of EnergyPlus; otherwise, the BEM is unstable and generates physically incorrect results.

Currently BEopt generates nonideal foundation systems models, which means that the BEopt foundation model would have to be altered to make it ideal; this is required for the application of the BEM to be optimal. The ideal model is an approximation of the real foundation systems in the target retrofit housing stock and thus introduces a known error into the whole-building simulated energy consumption. However, in view of the complexity inherent in implementing the BEM, it is not recommended for inclusion in BEopt as a means of overcoming BEopt's foundation modeling limitations.

Within these constraints, the BEM is suitable for generating foundation energy savings consistent with those measured experimentally as a function of insulation placement and thermal resistance for all the foundation types encountered in the NorthernSTAR service territory. It thus provides a viable alternative to the (as yet unrealized) fully integrated whole-building/three-dimensional earth contact simulation that otherwise would be required. It also provides the necessary analysis capability to permit the NorthernSTAR team to proceed with its foundation insulation retrofit program.

1 Introduction

1.1 Motivation

The work described in this report was motivated by the NorthernSTAR Building America team's need to evaluate the foundation insulation savings potential for the retrofit housing stock in climate zones 6 and 7. This stock, particularly houses built before 1950, is characterized by above-grade (AG) wall heights of at least 18 in. (and sometimes higher than 30 in.). Further, a significant number of houses built after 1950 have walkout or lookout basements. Surface snow melt in these climate zones causes the soils to typically be vapor—and often liquid—saturated, particularly in the critical (for basement wall drying) spring season. Thus, freezing temperatures and large frost depths (typically in excess of 3 ft in zone 7 adjacent to a foundation wall) on saturated soils have large impacts on the soil thermal behavior, in terms of phase change effects and thermal conductivity. Further, basement slab heat transfer to the soil deep ground temperature (taken to be the temperature of the local well water) is significant and needs to be included in the energy performance assessment.

As configured at the start of this project, BEopt could not model any of these effects as well as other foundation configuration parameters, specifically:

- Soils with moisture- and temperature-dependent thermal conductivity
- Phase change effects
- Slab heat transfer (assumed to be adiabatic in BEopt)
- Slab insulation (particularly retrofit insulation installed above the slab)
- AG wall exposure
- Walkout and lookout basements
- Three-dimensional effects (BEopt+ invokes a pseudo two-dimensional earth contact model embedded in EnergyPlus).
- Insulation placement configuration (interior, exterior, and integral to the foundation wall or slab)
- Variable insulation thermal resistance as a function of height AG (an important optimization strategy in cold climates).

In contrast, the BEM includes all these effects.

Experimental foundation retrofit results (Robinson et al. 1990) indicated that the expected whole-house site energy savings from foundation insulation were quite low, ranging from 3%¹ to 18% for a basement, with varying degrees of space heating (from none to heated via forced air ducts) with floating temperatures. Insulation placement was also a factor—interior placement yielded higher savings than exterior placement. Further, a comparison of the results with a two-dimensional earth contact simulation code—excluding phase change and nonlinear temperature and moisture content dependent soil properties (Shen 1988)—showed that the experimentally measured savings were a little less than one third of the simulation savings.

¹ Some cases showed an increase in energy consumption.

Given these experimental data and the shortcomings of BEopt, it was essential to find a methodology for estimating potential foundation retrofit savings in cold climates that would be realistic and congruent with the experimental data. The programmatic requirements for the methodology were:

- It had to be integrated into BEopt to meet the Building America program requirements.
- The budget was very limited, so developing a new methodology of any kind was not possible.

These requirements could be met only by using a methodology that had been developed and applied in a previous project (Goldberg and Huelman 2005). In this project, the BUFETS three-dimensional earth contact simulation code was combined with the EnergyPlus whole-building energy simulation to develop the Minnesota foundation energy code rules that were incorporated into the 2009 Minnesota Statutes (Chapter 1322). The input file for EnergyPlus could be generated by BEopt, so the methodology was suitable for integration with BEopt as required.

The purpose of this project was to apply the BUFETS/EnergyPlus methodology to three climates in zones 6 and zone 7 and compare the results with those generated by BEopt. There was no intention (and no budget) to perform any validation of BEM, and certainly not at a detailed level of heat fluxes and temperatures. Long-standing discrepancies with the BUFETS/EnergyPlus results with respect to sensible foundation cooling loads were known in advance (Goldberg 2010), but these are not a factor in the prediction of the predominating foundation heating loads, because the sensible cooling loads are quite small. The only intention was to reveal and document these discrepancies so they could be taken into account in assessing the energy savings results produced by the model.

1.2 Implementation

This report focuses on an evaluation of the BEopt tool with regard to its ability to provide a realistic assessment of the energy performance of full basement and crawlspace foundations in U.S. climate zones 6 and 7 by comparing it with the BEM in terms of whole-house energy performance. The report also includes a section on the selection of retrofit foundation wall systems to be evaluated experimentally at a later date, as this is a Statement of Work deliverable.

The report is divided into two principal sections. Section 2 describes the selection of retrofit full basement wall insulation systems to be tested experimentally in subsequent research projects for their hygrothermal performance and durability in zone 6 and 7 climates.

Section 3 is devoted to the BEopt/BUFETS/EnergyPlus comparative evaluation. The work builds on previous research that developed the foundation model used to generate the energy performance data in the *Building Foundation Design Handbook* (Labs et al. 1988). That model was based on DOE2.1C as the base whole-building energy simulation and a two-dimensional earth contact thermal conduction-only simulation code (Huang et al. 1988). Subsequently (Goldberg and Huelman 2005), the model was improved by replacing DOE2.1C with EnergyPlus and the two-dimensional earth contact simulation with the three-dimensional BUFETS simulation. In this project, the BEM was modified to allow the EnergyPlus input file to be generated by the BEoptE+ tool.

The results demonstrate the limitations of the model (particularly with regard to cooling load discrepancies) and clearly demarcate the set of conditions and requirements for which the model yields reasonable results in absolute and relative terms. But to reiterate, this is not a validation exercise. The basis of this investigation is to examine the performance of the model when applied to foundations in which the earth contact and EnergyPlus simulations are optimally or ideally matched in terms of basement interior boundary conditions as well as when they are suboptimally or non-ideally matched. Generally, BEopt does not generate foundation boundary conditions that are ideally matched to those of the earth contact simulation. Hence, the impacts on the overall simulated foundation energy performance of using the non-ideal BEopt boundary conditions with minimal modification in the earth contact simulation are clearly indicated. The results show how the BEopt models need to be modified to generate ideal earth contact simulation boundary conditions to produce optimum foundation energy system performance results.

2 Experimental Test System Selection

2.1 Introduction

The selection of the retrofit foundation wall test systems to be experimentally evaluated for cold climates (zones 6 and 7, the NorthernSTAR “service territory”) was based on the following criteria:

- Hygrothermal performance. Section N1102.2.6.12 (Foundation wall insulation performance option) of Minnesota Statutes chapter 1322 of 2009 (Minnesota Residential Energy Code). This defines a set of performance criteria with which foundation wall systems must be in compliance to meet the performance option of the Code.
OR:
Section N1102.2.6.7 (Interior foundation insulation requirements) of Minnesota Statutes chapter 1322 of 2009 (Minnesota Residential Energy Code). This defines prescriptive interior wall insulation systems. It must be noted that wall systems that are in compliance with the prescriptive option do not in general meet the requirements of the performance option.
- The experimental application of the performance option as discussed in Goldberg et al. (2010).
- The selected wall systems must be in compliance with the hygrothermal performance or prescriptive options for at least the interior temperature and humidity boundary conditions stipulated in Sections 4.3 and 4.3.2, respectively, of ANSI/ASHRAE Standard 160-2009 (Criteria for Moisture-Control Design Analysis in Buildings).
- The insulation R-values ideally shall meet the values for foundation walls given in Table 402.1.1 of the 2012 International Energy Conservation Code (IECC), but at least be in compliance with the R-values required by the 2009 Minnesota Energy Code.

All the foundation wall systems selected have the potential of meeting these criteria based on a large body of experimental data describing the hygrothermal performance of foundation wall systems.² These data were encapsulated in a series of wall system schematic designs reported in Goldberg and Huelman (2005). Some fairly common designs of interior foundation wall retrofits have been eliminated based on their experimentally demonstrated poor hygrothermal performance. Typical of these systems is the so-called “energy wall” consisting of a 2 × 4 stud frame filled with R-11 or R-13 fiberglass batts and covered on the interior—and sometimes on the exterior—with polyethylene membrane (usually 4 or 6 mil. thick) and a gypsum interior finish. Relatively permeable board insulation, such as expanded polystyrene and semi-rigid fiberglass (mineral wool) with no warm-side vapor retarder, also have proved to be hygrothermally problematic, as has open-cell spray polyurethane foam, (again without a warm-side vapor retarder). Systems with these configurations also have been excluded.

2.2 Selected Experimental Wall Test Systems

The experimental wall test systems are described in Table 1. Ten systems were specified in concordance with the capabilities of the Cloquet Residential Research Facility (CRRF), where

² See www.buildingfoundation.umn.edu for a sampling of the available research reports.

the testing will take place. Each system will be tested on a north and a south exposure. Ideally, the systems will also be tested on masonry block and poured concrete walls for a total of 20 test configurations. Testing on both wall configurations will demonstrate the impacts on hygrothermal durability of the hollow cores in masonry block walls. It will also allow an evaluation of how differences in surface absorptivity between poured concrete and masonry blocks affect condensate rundown. Whether this will be achievable in practice will be a function of the available budget.

The test systems have been split evenly into two groups. The first group of five systems will be installed without an interior water separation plane (WSP)³ in compliance with the prescriptive option of the Minnesota Energy Code. This option does not require an external WSP (N1102.2.6.7-11) and only requires an interior WSP for wall-contacting fiberglass batt insulation (N1102.2.6.11) that, in any case, is not one of the selected systems. Thus, all the chosen systems do not meet the performance option for at least the reason that they do not have a WSP (Section N1102.2.6.12.1). This is based on the operational assumption that it is exceedingly rare to find a basement in a house targeted for retrofit foundation wall insulation that has an exterior WSP (such as waterproofing; damp-proofing does not meet the specification of a WSP).

The second group of five systems will be installed with two types of interior WSPs, either adhered (such as a spray- or trowel-applied rubberized membrane) or non-adhered (such as conventional, edge-sealed polyethylene membrane).

Two alternate systems have been specified for system 10. The alternate system is the latest revision of the proprietary Owens Corning “Basement Finishing System” that will be deployed as an example of an available commercial system-based product, if the necessary support from the manufacturer can be obtained. Whether this system meets either the performance or the prescriptive option of the Minnesota Energy Code is yet to be determined.

All the foundation systems, except systems 4, 8, and possibly 10b (alternate), meet the R-15 rigid/R-19 batt standard of the 2012 IECC. Systems 4 and 8 are included because they meet the insulation standard of the 2009 Minnesota Energy Code (Section N1102.2.6.4) and because, compared to a 3 in. thick board, they will demonstrate whether 2 in. of extruded polystyrene provides a sufficiently low permeance to justify their use without a WSP.

2.3 Closing Comment

The retrofit foundation wall systems selected for experimental evaluation span the range of systems that are likely to be durable based on prior experimental results and in compliance with either the performance or prescriptive options in the 2009 Minnesota Energy Code. A commercial system that may not be in compliance with either code option is included as an alternate because it is an available retrofit option. The chosen systems also allow the hygrothermal durability impacts of the higher insulation R-values specified in the 2012 IECC to be evaluated in a cold climate (zones 6 and 7).

³ A WSP is defined as a single component or a system of components creating a plane that effectively resists capillary water flow and water flow caused by hydrostatic pressure and provides a water vapor permeance of 0.1 perms (5.75 ng/s.m².Pa) or less to retard water vapor flow by diffusion.

Table 1. Experimental Interior Retrofit Foundation Wall Systems

Interior WSP		
None* (Bare Wall Surface)	Adhered* (Peel-and-Stick Membrane, Spray Applied)	Nonadhered* (Polyethylene or Other Membrane)
1. Closed cell spray polyurethane flashing (~1 in. thick)/open cell spray polyurethane insulation in a 2 × 3 wood stud frame (full filling)/0.5 in. gypsum wall board		
2. Closed cell spray polyurethane flashing (~1 in. thick)/open cell spray polyurethane insulation in a 2 × 3 wood stud frame (full filling)/2-mil. PA-6 membrane/0.5 in. gypsum wall board	6. Closed cell spray polyurethane flashing (~1 in. thick)/open cell spray polyurethane insulation in a 2 × 3 wood stud frame (full filling)/2-mil. PA-6 membrane/0.5 in. gypsum wall board	
3. Edge-sealed 3 in. thick extruded polystyrene rigid insulation/2 × 3 open stud frame/0.5 in. gypsum wall board	7. Edge-sealed 3 in. thick extruded polystyrene rigid insulation/2 × 3 open stud frame/0.5 in. gypsum wall board	9. Edge-sealed 3 in. thick extruded polystyrene rigid insulation/2 × 3 open stud frame/0.5 in. gypsum wall board
4. Edge-sealed 2 in. thick extruded polystyrene rigid insulation/R-11 fiberglass batts in 2 × 4 stud frame/2-mil PA-6 membrane/0.5 in. gypsum wall board	8. Edge-sealed 2 in. thick extruded polystyrene rigid insulation/R-11 fiberglass batts in 2 × 4 stud frame/2-mil PA-6 membrane/0.5 in. gypsum wall board	10a. Edge-sealed 2 in. thick extruded polystyrene rigid insulation/R-11 fiberglass batts in 2 × 4 stud frame/2-mil PA-6 membrane/0.5 in. gypsum wall board
5. Dual foil-faced 2-in thick polyisocyanurate insulation board with both foil faces edge sealed (per Minnesota energy code)/2 × 3 open stud frame/0.5 in. gypsum wall board		
		10b.(alternate to 10a) Owens-Corning “Basement Finishing System”©

* Layers are listed in wall to interior order.

3 Energy Performance Modeling

3.1 Description of the BUFETS/EnergyPlus Simulation Methodology

The object of the methodology is to incorporate three-dimensional foundation envelope heat transfer into the EnergyPlus whole-building energy simulation program for arbitrary foundation system configurations. In the current EnergyPlus model, the foundation heat flows are computed in one dimension using a set of monthly average ground temperatures calculated by a separate two-dimensional conduction finite difference program. This approach is intrinsically incapable of modeling the three-dimensional heat transfer phenomenology inherent in foundation systems, particularly those with an AG wall exposure of 4 in. or more⁴ (Maref et al. 2000).

In this methodology, the foundation simulations are performed with the BUFETS (BUilding Foundation and Energy Transport Simulation) simulation code (revision C.). This proprietary program was specifically designed for simulating the heat transport through building foundation envelopes and originally developed to validate the experimental data generated at the University of Minnesota's Foundation Test Facility (FTF) (Goldberg 2011). BUFETS has the following salient features:

- Nonlinear material properties as arbitrary functions of temperature and moisture content
- Three-dimensional geometry
- Arbitrary, time-dependent boundary conditions
- Boolean geometry specification and mesh generator
- Fully discontinuous phase change physics with frost-front tracking
- High speed stable solver (enables multiyear real-time simulation of large discrete volume meshes (>100,000 volumes))
- Graphical animation outputs
- Arbitrary coupling of data outputs (fluxes, temperatures, U-values)
- 8760 hours simulated per year with an arbitrary time step size (typically 1 hour to comply with standard Typical Meteorological Year [TMY] weather data).

BUFETS also has the following limitations:

- Includes no gaseous (air, water vapor) transport. Hollow masonry block walls cannot be accurately modeled, especially when there is a buoyant cavity flow in the cores. This also applies to porous interior insulation such as fiberglass batts.
- Includes no bulk water transport. The soil moisture content field is entered as a simulation parameter and held constant.

The basic simulation approach is to mesh one full quadrant of a rectangular foundation system so that the vertical planes of symmetry are adiabatic (Figure 1). Each BUFETS simulation is run for

⁴ International Residential Code (2006), section R404.1.6: 4 in. is the minimum above-grade wall height allowed.

at least two calendar years so that the first year is used to condition the soil temperatures to pseudo-steady-state initial values.

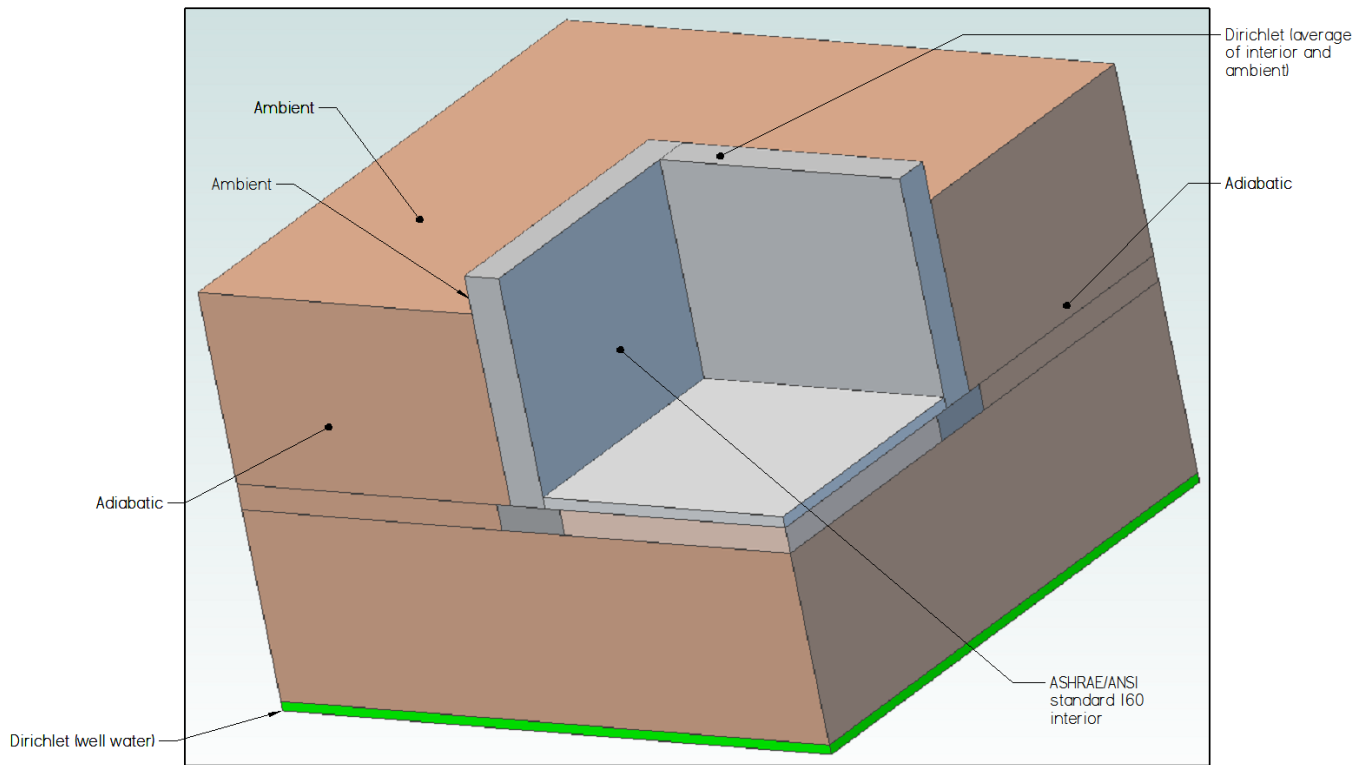

Figure 1. BUFETS boundary conditions

Generally, a two-year initialization period is insufficient to establish full steady-state cyclic thermal equilibrium in the soil for a given set of ambient and foundation interior boundary conditions; a 10-year period is more appropriate. However, given that a single-year simulation of the foundation model used in this project required 10 hours of computation,⁵ insufficient time was available for 10 years of computation for the 42 foundation systems simulated. However, use of a two-year initialization does not affect the relative physical accuracy of the results, which, as shall be explained later, is the only accuracy feasible for this methodology.

The whole-house energy performance was determined using the EnergyPlus version 6.0.0 energy simulation program developed by the Building Technologies Program of the U.S. Department of Energy. The ambient boundary conditions are derived from the TMY3 data.⁶ In this project, the base EnergyPlus input files (.idf format, henceforward referred to as an IDF file) were generated by the EnergyPlus version of BEopt (BEoptE+). These include the full description of the house together with all the occupant lifestyle effects as defined in BEopt and are compliant with the relevant Building America protocols. The only aspects of the file that were changed were the

⁵ Simulations were performance on a 3.06 GHz dual quad-core 32-bit Intel Xeon workstation.

⁶ Available at the EnergyPlus website at http://apps1.eere.energy.gov/buildings/energyplus/weatherdata_about.cfm.

geometry and description of the foundation system and the set point temperature schedules. It is extremely important to emphasize this, because this allows the errors intrinsic to the standard BEopt foundation model to be demonstrated.

The interior boundary surface of the foundation system quadrant modeled in BUFETS is divided into the following seven sections:

- AG wall center
- AG wall corner
- Below-grade (BG) wall center
- BG wall corner
- Slab corner perimeter
- Slab center perimeter
- Slab center section.

A generalized application of this model to a full basement with a lookout wall is shown in Figure 2.

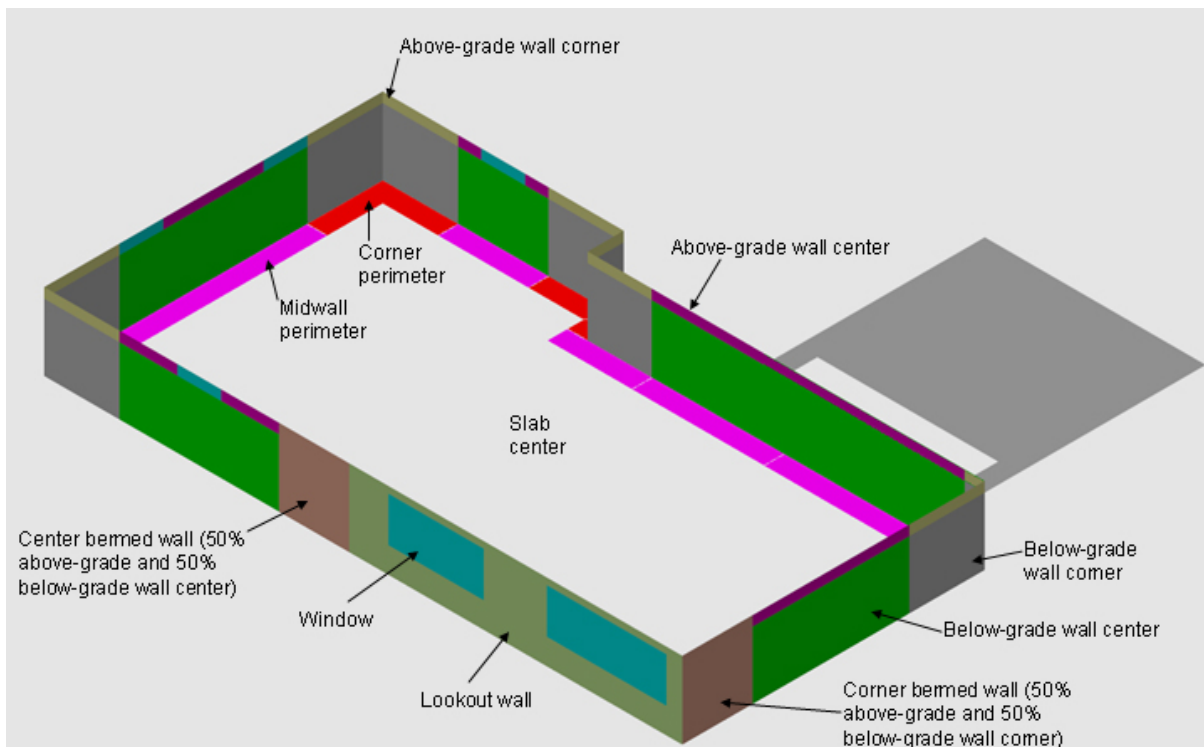

Figure 2. Generalized application of the model to a full foundation

Figure 3 is a flowchart that shows how BUFETS, EnergyPlus, and BEoptE+ are linked. The foundation system quadrant is simulated in BUFETS using the relevant ambient EnergyPlus

weather file (.epw format also used by BEoptE+) and the ASHRAE/ANSI Standard 160 interior temperatures generated from that ambient weather file. The only reason for this particular choice of interior boundary condition is that it is a published standard and thus represents some degree of consensus. However, there is no restriction on adopting a different standard for the interior boundary conditions.

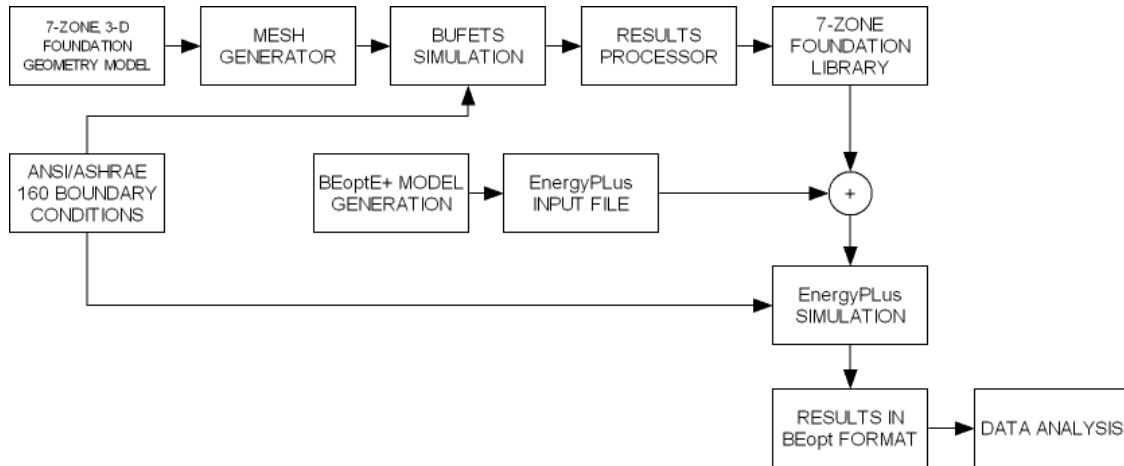

Figure 3. BUFETS/EnergyPlus/BEopt simulation methodology flowchart

BUFETS generates a set of earth contact coupling data for each foundation system section that can then be incorporated into the EnergyPlus IDF file generated by BEopt. Each dataset consists of an 8760-hour schedule of values and a specification of the foundation surface section to which it refers. The specifics of each coupling dataset are shown in Table 2.

Table 2. BUFETS/EnergyPlus Foundation Section Coupling

BUFETS Foundation Section	EnergyPlus “BuildingSurface:Detailed” Object Construct	EnergyPlus Auxiliary Object Construct
AG Wall Center	Outside Boundary Condition = “Outdoors”	“SurfaceControl:MovableInsulation”
AG Wall Corner	Outside Boundary Condition = ”Outdoors”	“SurfaceControl:MovableInsulation”
BG Wall Center	Outside Boundary Condition = ”OtherSideCoefficients”	none
BG Wall Corner	Outside Boundary Condition = ”OtherSideCoefficients”	none
Slab Corner Perimeter	Outside Boundary Condition = ”OtherSideCoefficients”	none
Slab Center Perimeter	Outside Boundary Condition = “OtherSideCoefficients”	none
Slab Center Section	Outside Boundary Condition = “OtherSideCoefficients”	none

The AG sections are coupled using the “MovableInsulation” construct for which BUFETS generates an 8760-hour schedule of R-values for the movable insulation and a base material layer (“Material:NoMass”) for the movable insulation with an R-value of 1. The net coupling R-value is the product of the scheduled value and the base material layer of unity yielding only the scheduled R-value. The wall construction for the AG components is thus established as the interior finish layer only, in this case, ½-in. gypsum wall board. The balance of the wall (poured concrete and insulation) is included in the “movable insulation” construct. This approach allows EnergyPlus to calculate the full radiation heat transfer balance on the AG exterior wall surface. The heat transfer through the AG wall components is a function of the scheduled R-value, the interior temperature, and the ambient temperature.

The BG sections of the walls and the slab sections are coupled using the “OtherSideCoefficients” construct⁷ for which BUFETS generates an 8760-hour schedule of temperatures and a zero mass wall or slab component material layer with a fixed R-value. These R-values are the nominal one-dimensional heat flow R-values for the wall and slab components. The BUFETS-generated interior wall heat transfer (which depends on the full earth contact temperature field) through these sections is represented as a function of the fixed R-value, the scheduled ground temperature, and the interior temperature. In this approach, the actual BUFETS wall heat fluxes are transmuted and represented by the scheduled ground temperatures. This procedure is not the same as that used in the current earth contact model incorporated into EnergyPlus that is based on the monthly average ground temperatures generated two dimensionally. In contrast, the BUFETS-based procedure yields the heat flux at the interior foundation envelope surface calculated three dimensionally for 8760 hours.

The BUFETS earth contact coupling data are packaged with an ASHRAE/ANSI 160 (AA160) interior temperature schedule into a library. A macro procedure is used to generate the coupling data as an IDF file and combine it with the BEopt base IDF. A separate library is required for each foundation insulation configuration for each climate.

For this procedure to be physically accurate, the following limitations and restrictions apply:

- Both BUFETS and EnergyPlus must be run using exactly the same interior and exterior boundary conditions for the foundation system (basement or crawlspace) being considered (see Section 2.2 for a full discussion). This means that the ambient weather file (“.epw” format) and internal ASHRAE/ANSI 160 interior temperatures generated from that weather file must be identical in both simulations for the foundation system under consideration.
- A separate BUFETS library is required for each foundation insulation configuration (interior, exterior, structural insulated panel, integral, etc.) for each climate. In this project a demonstration of using a library generated for one climate in a different climate is provided so the impacts of the resulting errors can be assessed.
- As BEopt only generates basement geometries in which all the walls are entirely BG and the slab is treated as adiabatic, the resulting IDF has to be considerably modified

⁷ The following fields only were used: Constant Temperature Coefficient=1; Constant Temperature Schedule Name=<Schedule Name>. All other fields were 0 or blank.

geometrically to create a foundation geometry that corresponds to the 7-section BUFETS model shown in Figure 2 and Table 2. Even when executed graphically (using, for example, the Google Sketchup program), this tedious process requires a great deal of care to avoid errors.

The specific procedure for the BEM used in this project is:

1. Develop the foundation library (see Table 1), including the ASHRAE/ANSI 160 interior temperature boundary conditions for the ambient weather file used. A separate library is required for each foundation configuration in each climate.
2. Develop a baseline house/foundation model in BEoptE+ (version 1.1 was used) for each climate being studied (in this case, Minneapolis and Bemidji in Minnesota and Janesville in Wisconsin) and for each foundation type (full basement and crawlspace).
3. Run the baseline models for all the insulation thermal resistances for each climate and for all the insulation thermal resistances included in the test matrix. Retain the output results table generated by EnergyPlus for later analysis.
4. Capture the IDF for the R_{US-0} (that is, the thermal resistance in British units in common usage in the United States) case for each climate and foundation type. Graphically modify the input file to represent the BUFETS foundation model in terms of the seven foundation envelope sections discussed above. Two modified input files were generated.
 - a. A BG foundation wall only as generated by BEopt version 1.1 (which cannot generate AG foundation elements)
 - b. A typical AGBG configuration typically found in the zones 6 and 7 retrofit housing stock.
5. Configure the foundation building surface details to comply with the structures of Table 2.
6. Merge the resulting IDFs with the appropriate BUFETS foundation library.
7. Change all the heated space set point temperature schedule specifications to refer to the AA160 schedule included in the foundation library.
8. Run the resulting IDF directly in EnergyPlus and retain the tabular output files for later analysis. Note that the output files are the same as those imported back into BEopt. Communication with NREL personnel revealed that the tables generated outside of BEopt cannot be imported into BEoptE+ 1.1, although this capability apparently will be available in future releases.⁸

All the steps (except step 6) were accomplished manually. However, as only one EnergyPlus input file is necessary for each foundation configuration in each climate, running multiple R-value cases using the automated procedure of step 6 significantly reduced the amount of manual effort.

⁸ Email from Scott Horowitz dated 11/30/11.

Many people may consider this to be a complex and impractical procedure. However, in principle, there is no reason why a description of the foundation system using the defined seven-section structure could not be generated in BEopt, thus eliminating this tedium (if it were ever determined that this approach is a viable solution to improving earth contact modeling in BEopt). This approach does enable the current deficiencies in the BEopt ground contact model (exclusion of lookout/walkout basements, AG wall exposure, three-dimensional heat transfer, etc.) to be overcome so that it can be applied to the actual retrofit housing stock in zones 6 and 7 now, thus solving the immediate problem faced by the NorthernSTAR team.

3.2 Simulation Methodology Application

The BEM discussed is a refinement of the model originally conceptualized by the principal investigator for the foundation energy performance results reported in the Building Foundation Design Handbook (Labs et al. 1988; Huang et al. 1988). In that case, DOE 2.1C was used as the whole-building energy performance simulation program and the earth contact modeling was carried out using a variant of the two-dimensional “Shen” code (Shen 1986).

The key and crucial requirement for the accuracy of this model as the union of separate or decoupled whole-building energy and earth contact thermal simulations is that the foundation system (not the whole-building) boundary conditions be identical in both models. Ideally, the model requires an iterative application of the earth contact and whole-building simulations, because in most residential building energy models (including those generated by BEopt and used in this project) treat the basement or crawlspace temperature as floating. The set point temperature schedule is applied to the thermostat located in the AG living space so the basement or crawlspace temperature does not remain constant. To achieve boundary condition equality, the energy simulation is run first to generate an interior foundation system temperature profile that is in turn used by the foundation model to generate the earth contact heat fluxes. These heat fluxes are then used by the whole building simulation to update the temperature profile and the procedure is repeated until the earth contact heat fluxes converge.

This requires a significant amount of computation. With the Shen/DOE2.1C combination, usually five iterations were required to achieve convergence. However, given the computational loads imposed by BUFETS (which are at least an order of magnitude larger than the Shen code), this level of iteration is not tractable, so this rigorous procedure is not practical for the BEM. Further, in the model currently used in EnergyPlus, an apparently arbitrary interior boundary condition is used *a priori* for a two-dimensional earth contact simulation to generate the average monthly ground temperatures are used in EnergyPlus. The floating foundation system interior temperature and the assumed earth contact simulation foundation system interior boundary temperature are usually not equal. This alone guarantees that the resulting foundation envelope heat flows used in the whole-building simulation are inaccurate.

The question arises as to the consequences of using mismatched whole building and earth contact simulation foundation system interior temperatures in the BEM in particular. Because this model seeks to include the full three-dimensional heat flow phenomenology captured by BUFETS into EnergyPlus by essentially eliminating the latter’s intrinsic one-dimensional heat flow calculation

paradigm entirely in the foundation system, application of the model has exacting stability⁹ requirements. Three cases need to be considered to investigate the full range of stability requirements:¹⁰

- The foundation system interior temperatures are identical in both simulations. In this case, the foundation system interior boundary heat fluxes generated by the earth contact simulation are exactly the same as those used by the whole-building energy simulation.
- The foundation system interior temperature profile in the earth contact simulation is higher than that in the whole-building energy simulation.

The model is stable and the heat fluxes will be in error nonlinearly proportionate to the difference between the temperature profiles. The magnitudes of the foundation system sensible heating and cooling loads can be used as a metric of the degree of interior boundary temperature inequality. For foundation systems in cold climates where the basement or crawlspace sensible (not latent) cooling load is small because there is no foundation insulation¹¹ (less than 5% of the sensible heating load), the size of the simulated foundation cooling load is a good measure of the degree of interior boundary condition inequality. The cooling load predictions in particular are very sensitive to differences in interior temperature, so even a small temperature difference of 0.5°C or so can have a substantial impact on the simulated cooling loads (long wave radiation heat exchange is a fourth power function of surface temperature). Generally, as the temperature difference increases (whole-building simulation temperature decreases relative to the earth contact simulation), the whole-building simulation heating loads decrease and the cooling loads increase. In these circumstances, which are generally the norm, the resulting simulated energy performance for the foundation system and for the whole building has only relative accuracy; in no sense is any claim of absolute accuracy valid. In practice, this means that only the foundation system energy differences as a function, typically, of insulation thermal resistance, relative to a fiduciary base have any physical validity.

- The foundation system interior temperature in the whole-building energy simulation is greater than that in the earth contact energy simulation. In this case, the model is unstable and generates meaningless foundation system boundary heat fluxes. There is a threshold temperature difference for the instability to arise that is somewhat specific case dependent, but it is generally of the order of tenths of a degree Celsius.

In the ideal application, the BEM is used in the context of a conditioned basement or crawlspace. In this case, an independently controlled heating plant is used to establish exactly the same

⁹ Stability is defined as the ability of the iterative application of the BUFETS and EnergyPlus simulations to converge to the same interior envelope surface heat flux. Instability is thus tendency of these heat fluxes to diverge completely or oscillate about some mean as the simulations are iterated.

¹⁰ Whether the iterative application of the BUFETS and EnergyPlus simulations will achieve stability is determined entirely by the foundation interior temperature boundary conditions used in the simulations.

¹¹ Foundation insulation decouples the basement from the fairly constant and cool BG temperatures that can, depending on the insulation location and thermal resistance, increase the sensible cooling loads.

foundation system interior temperature in EnergyPlus as used in BUFETS.¹² This allows the computationally intractable iteration between the two simulations to be avoided.

In this project, the BEopt models were used without modification, so they include floating basement and crawlspace temperatures with the resulting absolute accuracy issues discussed above. Generally, basement or crawlspace temperatures are lower than those of the conditioned AG or “living” (in BEopt parlance) spaces so that using the BUFETS interior set point temperature profile as the conditioned space set point temperature profile in EnergyPlus will yield stable and relatively accurate results. However, this is not universally true, particularly in basements with floating temperatures in which the foundation interior temperatures can increase with the addition of foundation insulation with only a small change in foundation envelope heat flux (Robinson et al. 1990). In these cases, the iterative procedure would have to be invoked to achieve stable operating conditions for the model.

All this phenomenology will be demonstrated in the results presented in subsequent sections.

3.3 BUFETS Simulation Foundation Building Models

The foundation models developed for the BUFETS simulations are shown in Figures 4 through 6. These models represent a consensus within the NorthernSTAR foundations team of the typical full basement and crawlspace retrofit housing stock in climate zones 6 and 7. Figure 4 shows a full basement with an 8-ft tall poured concrete foundation wall extending upward from the footing with an 18-in. AG exposure. A 3½-in. slab rests directly on the footing and the soil domain extends 12 ft horizontally and vertically beyond the foundation envelope. Ramsey sandy loam is selected as the soil type with an 8-in. cover of Northway silt loam as the “agricultural” layer for growing a garden. Poured concrete walls likely are not the norm for the target retrofit housing stock foundation walls that tend to be fabricated from masonry blocks. However, given the modeling limitations of BUFETS and the focus on relative energy performance (or energy savings) that is at the core of the BEopt procedure, use of poured concrete is reasonable because the impact of this assumption is known (see Section 3.1).

¹² The foundation interior temperatures in BUFETS are scheduled and thus they can be made exactly the same as those of EnergyPlus.

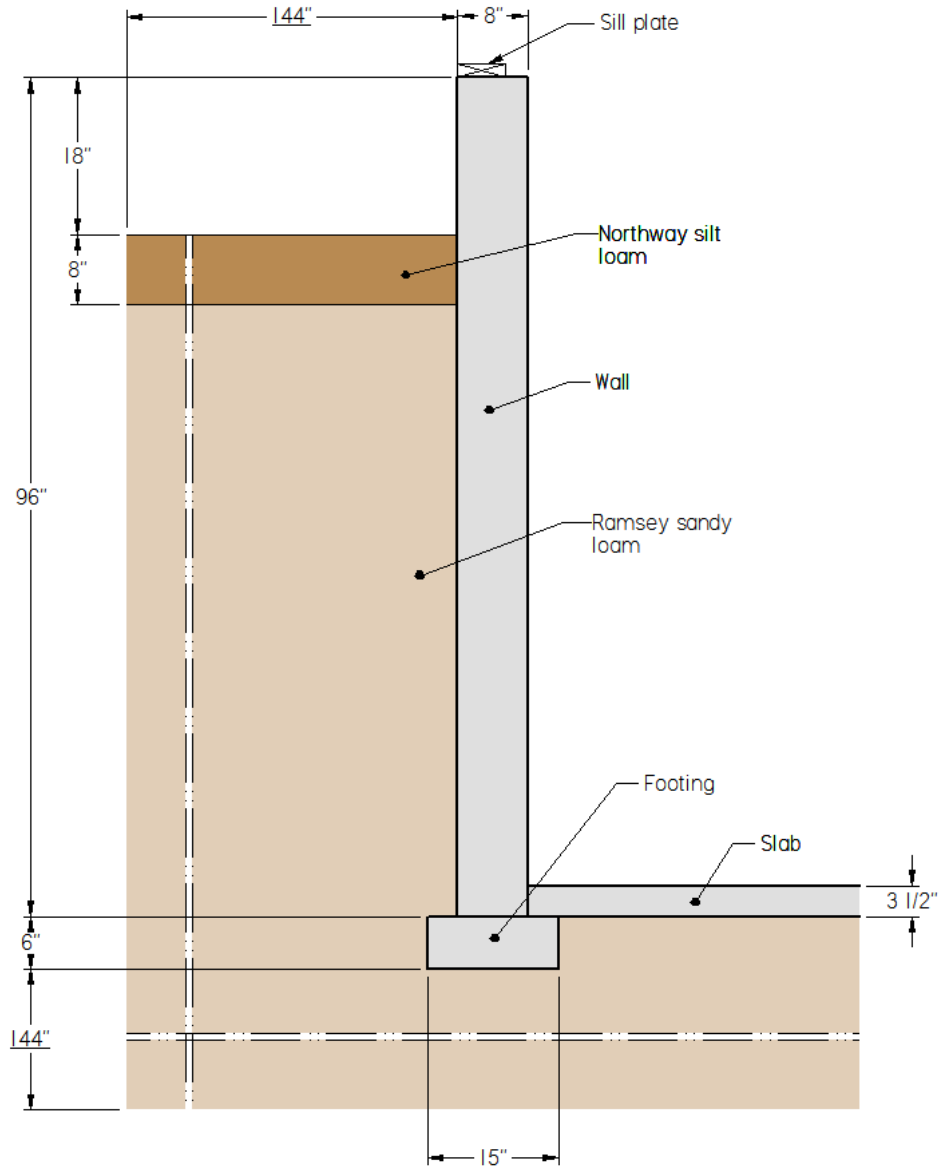

Figure 4. Retrofit full basement foundation vertical section (without insulation)

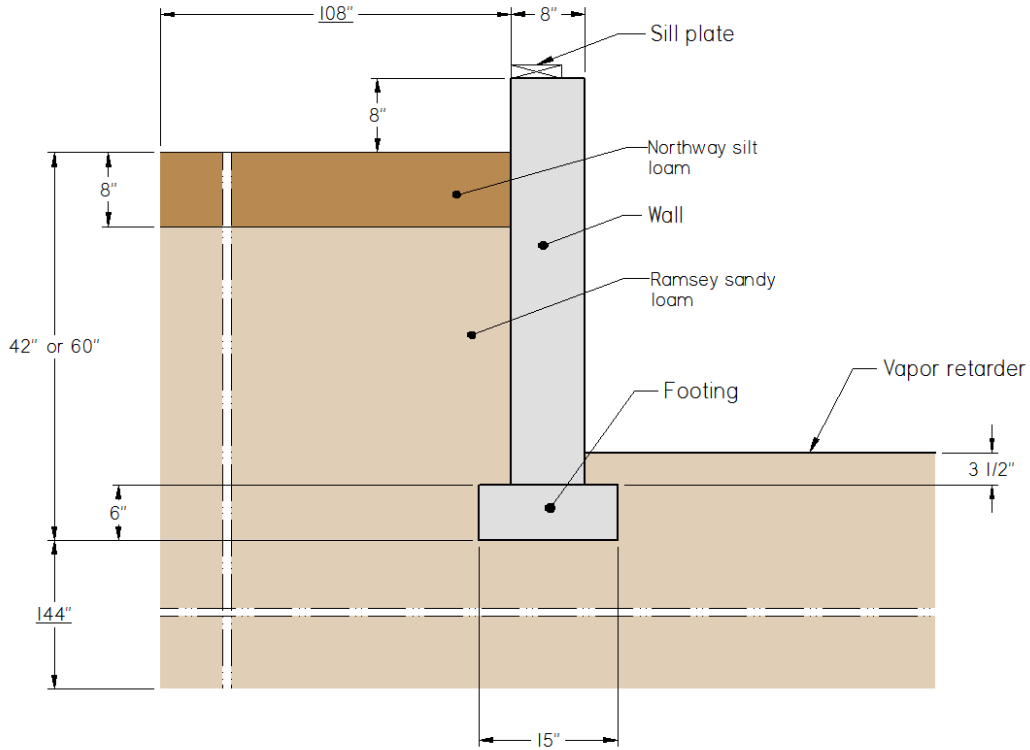

Figure 5. Retrofit crawlspace foundation vertical section (without insulation)

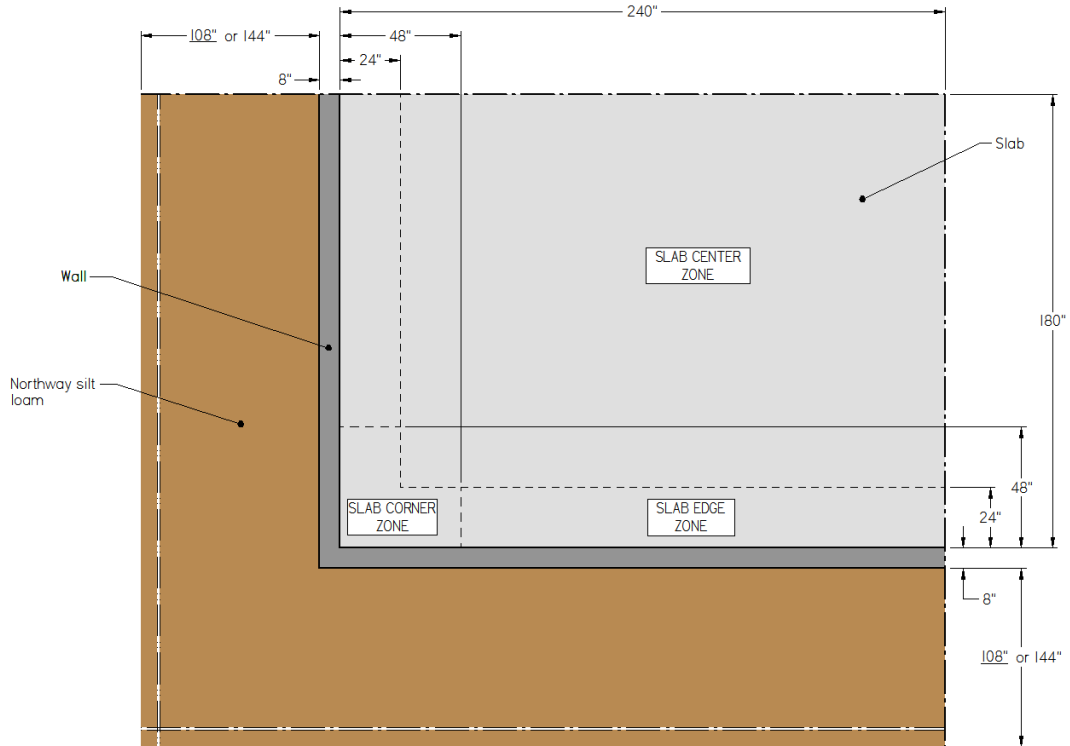

Figure 6. Retrofit foundation plan common to full basement and crawlspace sections (without insulation)

A sill plate is included on top of the wall. In the case of an exterior insulation placement, the wall insulation extends from the top of the footing to the top of the wall. With an interior insulation placement, the interior insulation extends from the top of the slab to the top of the wall. Additional insulation extends inward from the interior face of the sill plate to the interior surface of the wall insulation. In all cases, the top of the sill plate and associated inboard insulation is assigned a Dirichlet (temperature) boundary condition and is not assumed to be adiabatic. The top surface of the exterior insulation is assumed to be adiabatic because the heat flow is essentially one dimensional through the insulation in the rim joist zone.

Figure 5 depicts the crawlspace foundation model. The vertical cross-section is essentially the same as that of the full basement, except that the net BG depth is set to the code required frost depth (60 in. for zone 7 and 42 in. for zone 6) The AG exposed height is 8 in. and the horizontal soil domain is reduced to 9 ft because the BG foundation is deeper. Further, the concrete slab in the full basement is replaced with the same thickness of sand as is usual practice.

With reference to Table 1, separate BUFETS vertical envelope heat transfer sections are assigned to the AGBG portions of the wall in both the full basement and crawlspace configurations.

The foundation model plan is shown in Figure 6. The three BUFETS heat transfer sections on the full basement slab (or crawlspace floor) are shown. AGBG wall heat transfer sections correspond to the slab corner and slab edge sections. The soil domain vertical boundaries are assumed to be adiabatic, as the far field heat transfer is essentially one dimensional vertically. The bottom horizontal soil boundary is again a Dirichlet condition with the temperature held constant at the well water temperature for the particular geographic location.

The assigned constant soil moisture contents for the full basement foundation are shown in Table 3; those for the crawlspace are given in Tables 4 and 5 for 42 in. and 60 in. frost footings, respectively. The moisture content is defined in terms of a nondimensional soil saturation ratio; that is, the ratio of the volume of water in the soil with partially filled pores to the volume of water with fully filled (or saturated) pores. In all three tables, the arrows indicate a region where the saturation ratios are interpolated linearly between the bounding values. These profiles are intended to capture the thermal consequences of moist soils on the foundation heat transfer and are the same as those used in the analysis for the 2009 Minnesota Energy Code (Goldberg and Huelman 2005).

Table 3. Full Basement Foundation Soil Saturation Ratios

Depth BG (in.)	Saturation Ratio			
	Far Field	Exterior Footing Protrusion	Sub-Foundation Wall	Sub-Slab
0	0.25	0.25	n/a	n/a
8	0.5	0.5	n/a	n/a
74.5	↑	↓	n/a	n/a
78		0.93	n/a	0
84	↓	0.93	0.8	↓
140	0.5	0.5	0.5	0.5
228	1.0	1.0	1.0	1.0

The saturation ratios are interpolated linearly in the vertical direction between the tabulated values.

Table 4. Crawlspace Foundation Soil Saturation Ratios for 42-in. Frost Footing

Depth BG (in.)	Saturation Ratio			
	Far Field	Exterior Footing Protrusion	Sub-Foundation Wall	Sub-Slab
0	0.25	0.25	n/a	n/a
8	0.5	0.5	n/a	n/a
36	↑	0.93	n/a	0
42	↓	0.93	0.8	↓
98	0.5	0.5	0.5	0.5
186	1.0	1.0	1.0	1.0

Table 5. Crawlspace Foundation Soil Saturation Ratios for 60-in. Frost Footing

Depth Below Grade (in.)	Saturation Ratio			
	Far Field	Exterior Footing Protrusion	Sub-Foundation Wall	Sub-Slab
0	0.25	0.25	n/a	n/a
8	0.5	0.5	n/a	n/a
54	↑	0.93	n/a	0
60	↓	0.93	0.8	↓
116	0.5	0.5	0.5	0.5
196	1.0	1.0	1.0	1.0

The full basement was modeled with four levels of insulation (R_{US-0} , R_{US-5} , R_{US-10} , R_{US-15}), in the following three configurations:

- Interior, extending from the top of the slab to the bottom surface of the sill plate inboard insulation (or top of the wall)
- Exterior, extending from the top of the footing to the top of the wall
- Interior insulation together with R_{US-5} exterior insulation extending from the top of the wall to 12 in. BG.

The crawlspace was also modeled with the same four levels of insulation as the full basement, but only in the interior wall configuration with the insulation extending from the top of the soil floor to the top of the wall.

In all cases, extruded polystyrene was used as the insulation to limit the number of simulation runs. In practice this is not a limitation; from a thermal perspective in which thermal conductance is the primary variable, any rigid insulation is satisfactory. Porous interior insulation (such as fiberglass batts) does introduce additional complications because of the potential for convective flows that are beyond the capacity of BUFETS (see Section 3.1), and thus was not used.

4 Model Comparison

The issue of validating large earth contact domain building foundation energy simulation programs has been a source of concern for at least two decades. The primary difficulty is that to achieve an absolute quantitative validation of such programs with experimental data, the soil properties must be defined at a fine¹³ enough resolution for accurate calculation. In particular, this requires precise in-situ measurements of dynamic (time-dependent) soil temperatures, relative humidities, and moisture contents, as well as precise knowledge of the soil material properties (thermal conductivity, matrix density, heat capacity, and settled [or installed] porosity).

Of all these parameters, the soil moisture content is perhaps the most critical and has the largest impact on the foundation system interior heat flows that determine the building's energy performance. For example, consider Ramsey sand, which has a dry soil thermal conductivity of 0.45 W/m.K and a frozen saturated thermal conductivity of 3.29 W/m.K, yielding a frozen saturated to dry conductivity ratio of 7.3. Absent precise experimental knowledge of the moisture content throughout the soil domain, it is simple to manipulate the soil moisture contents in the simulation to achieve any degree of validation based on measured calorimetric foundation system energy consumption.

This problem was recognized in the design of the FTF, and it became clear that installing the required amount of instrumentation was not only cost prohibitive, but using the technology of the time (1987/1988) would have required that so much copper wire be installed in the soil domain that the wire would change the domain's thermal characteristics.¹⁴ Thus, a different approach was adopted in which all the energy performance data would be referenced to a fiduciary standard so the impacts of the soil parameters would be normalized. All the foundation test modules were constructed to be physically identical in every respect except the specification of the BG envelope, which was the only experimental variable. A test module with poured concrete walls and slab without footings or reinforcing steel provided the fiduciary reference.

The soil around all the modules was engineered to be exactly the same in the simulation domain and the layout pattern of the modules enabled each module to experience the same wind speeds and snow cover for the prevailing weather conditions. The heat transfer through the ceilings (in the case of full basement modules) or the floors (in the case of slab-on-grade modules) was engineered to be extremely small, essentially achieving an adiabatic result. In the case of the basement modules, this included the boundary at the top of the walls that also was engineered to be essentially adiabatic. The modules were heated electrically and their energy consumption was measured calorimetrically providing an exact experimental measure of the thermal performance of their aggregate AGBG envelope components.

The experimental energy performance results of the various foundation envelope systems tested were always normalized with respect to the reference module, so normalizing for the effects of the unknown soil domain moisture contents, the ambient weather conditions, etc. (see Goldberg

¹³ The fineness of the resolution required is a matter of dispute because of the high measurement costs of soil moisture content, for example. Current practice is to use 3–4 ft grid spacing.

¹⁴ Currently available miniaturized wireless technology would theoretically eliminate this problem.

2011). These normalized data thus form the experimental dataset for validating the relative accuracy of foundation energy simulation codes when the FTF fiduciary methodology is used to test such codes. BUFETS was developed and tested to yield a high level of relative accuracy. Only in this relative sense has BUFETS been used to predict the impact of changes to foundation envelope insulation strategies. This approach is entirely appropriate for this project, in which the key focus is on the energy savings produced by foundation envelope insulation retrofits and for which, in any case, the soil domain properties are arbitrary.

4.1 Comparison With Experimental Data

The full basement comparison building (see Figure 7) was used to compare the BEM with the FTF experimental data. The comparison building had internal dimensions of 8.6 ft (height) × 26.2 ft (length) × 19.7 ft (width) with an AG wall exposure of 18 in.¹⁵ The basement ceiling was modeled as adiabatic; an EnergyPlus “ideal loads” heating, ventilation, and air conditioning (HVAC) system was used to generate the energy performance, which eliminated the complicating effects of plant efficiency, duct losses, etc. Also, the same set point temperature schedules were used in both simulations, so the interior temperatures in EnergyPlus and BUFETS were identical. Further, the comparison building model was not generated by BEopt to ensure that its parameters conformed to the ideal requirements of the BEM. The model thus was generated manually in EnergyPlus.

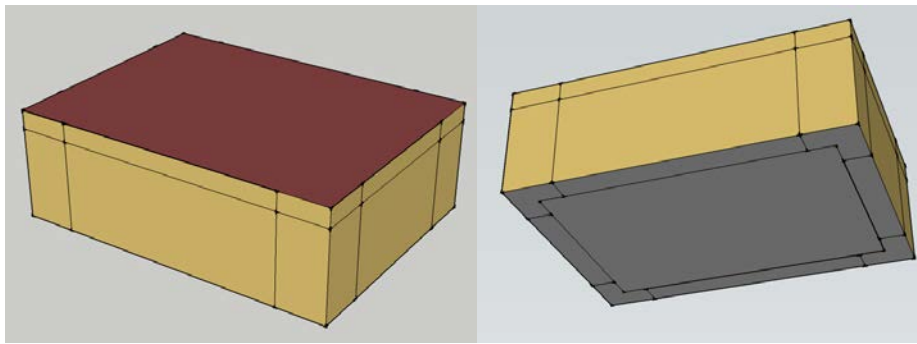

Figure 7. Comparison building

The full basement specification was in conformance with Section 3.3. The FTF database includes two relevant basement foundation configurations. The first test configuration is for a test module with hollow core masonry blocks and an uninsulated poured concrete floor with exterior R_{US}-10 extruded polystyrene; the second test configuration is for a structurally identical test module with interior R_{US}-10 extruded polystyrene. However, it is critical to appreciate that these test modules had hollow masonry block walls that introduced buoyant cavity flow thermal effects, while the comparison building has poured concrete walls. For the validation to be acceptable, these effects must be demonstrated by the simulation and experimental data comparison.

¹⁵ These building dimensions are deliberately different from the FTF full basement test modules with internal dimensions of 7.7 (H) × 19.3 ft (L) × 19.3 ft (W), because the size of the building is irrelevant as long as the reference and test buildings have the same dimensions and are larger than a certain minimum size (to effectively isolate corner and midwall effects).

The normalized simulated energy performance comparison metric is achieved by simulating the comparison building with no insulation as well as with R_{US-5} , R_{US-10} , and R_{US-15} extruded polystyrene insulating and plotting the $R_{US-*/R_{US-0}}$ simulated heating energy ratios against the insulation R_{US} values (no cooling energy measurements were made at the FTF). The experimental test module/reference module heating energy data are also plotted. The experimental reference and simulated comparison building are of poured concrete, so the only variables in the case of the simulation are the envelope insulation thermal conductance and placement. Experimentally, the variables are the insulation placement and a different structure.

The results of the comparison are shown in Figure 8 for interior insulation and Figure 9 for exterior insulation. The error bars for the experimental data show the repeatability bands for experiments conducted over several years. For the interior insulation case, the simulation shows a lower ratio than the experiment because of the effect of the buoyant cavity flows in the masonry block cores. Because the cores were outside the insulation, the temperature above the footing is larger than that in the exposed AG section during the heating season establishing a substantial cavity flow. It was shown experimentally (Goldberg 2011) that this flow accounts for a 4% normalized increase in heating energy consumption.

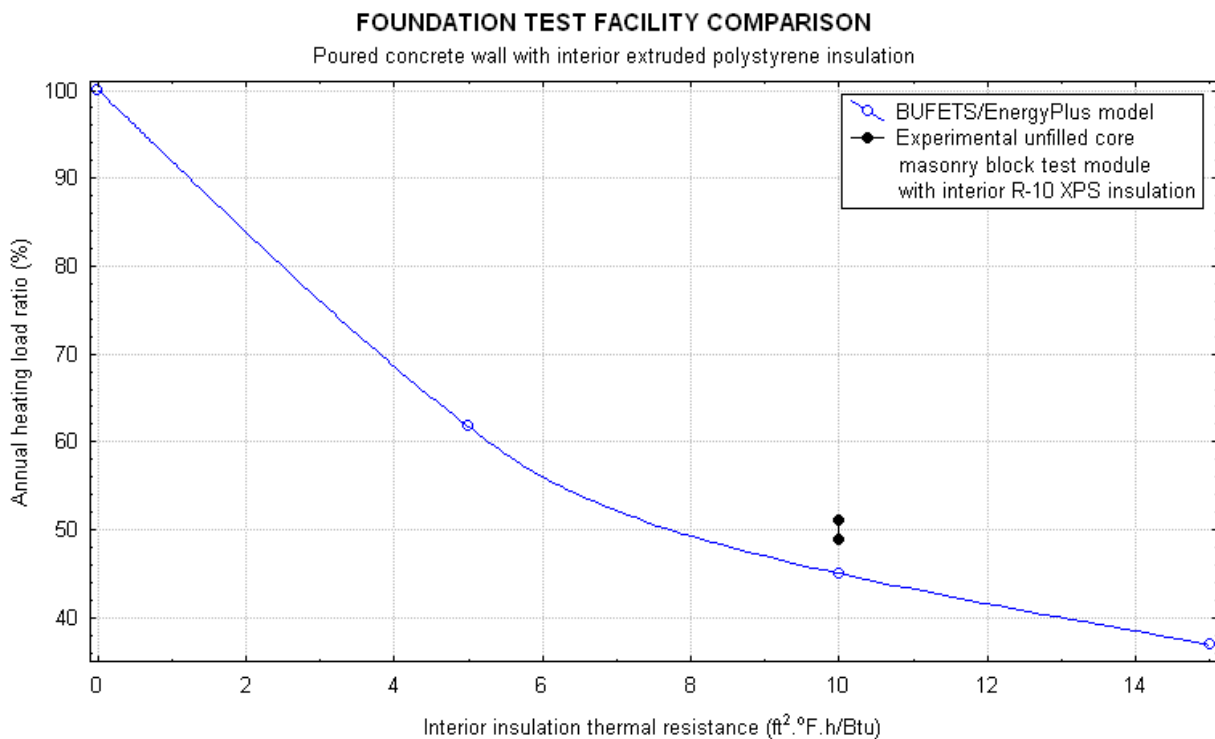

Figure 8. Comparison against FTF data for interior R-10 XPS full-wall insulation

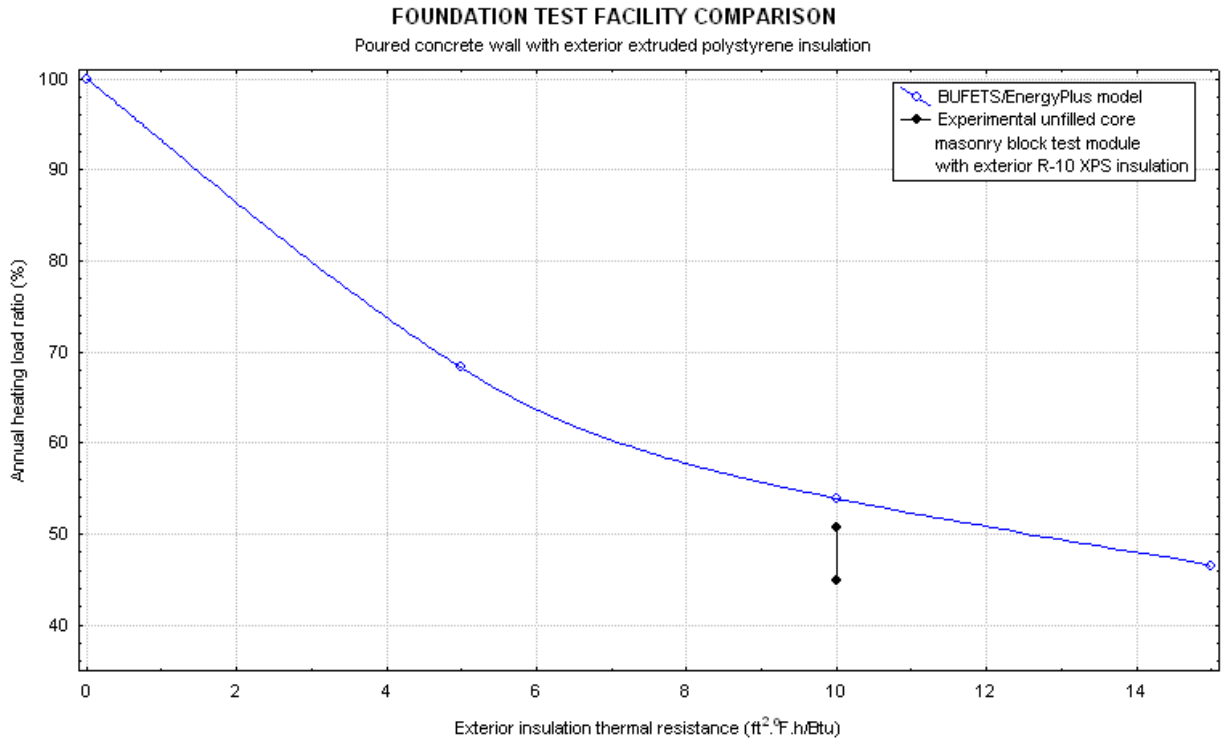

Figure 9. Comparison against FTF data for exterior R-10 XPS full-wall insulation

Numerically, the simulation yielded a heating load ratio of 45% and the experiment a range of 48.8%–51.1%. Adding 4% to correct the simulation for the effect of the buoyant cavity flows yields a ratio of 49% within the experimental repeatability.

For the exterior insulation case, the simulation yields a higher energy ratio than the experiment. Because the masonry blocks were within the insulation and the interior temperatures of the test modules (and basements with full-wall insulation in general) were stratified (temperature above the slab lower than that at the ceiling), there is no buoyant cavity flow and the still air in the cores effectively increases the thermal resistance of the masonry block wall. Numerically, the simulation yielded an energy ratio of 53.9% compared with the experimental repeatability band of 44.9%–50.6%. Because no experimental data were collected about the magnitude of the increased wall thermal resistance (afforded to masonry block walls accruing from their hollow cores by exterior insulation), no experimental correction to the simulated data can be made. However, taking the numbers at face value (and ignoring the buoyant cavity effect), there is a 6.2% difference between the simulation and mean experimental ratios. This is still within 10%, which is reasonable.

These data demonstrate the relative accuracy of the BEM under conditions in which the interior boundary temperatures in the basement are identical for whole-building and earth contact simulations, but the interior boundary temperature conditions in the simulations and the experiment were very different.

Extending the argument, even if the interior foundation system boundary conditions in the earth contact and whole-building simulations are different but meet the stability criterion, as long as the reference and test buildings are subject to the same overall boundary conditions (in the case of foundation systems with floating interior temperatures, the AG or “living space” temperatures are identical), then the relative accuracy is maintained even though there is no absolute accuracy. This arises because the foundation system interior is in effect lumped together with the wall system and subject to the same overall ambient and soil boundary conditions. The only assumption necessary for this (that is, that the basement can be treated as a lumped parameter boundary to the living space) to be true is that in the EnergyPlus models, the coupling between the living space and the interior surfaces of the foundation envelope is consistently and repeatedly executed. However, this is true only when the stability criterion is met; that is, the foundation interior temperatures in the whole-building simulation are lower than those used as the BUFETS interior boundary condition.¹⁶

The question arises: Why is it necessary to develop an EnergyPlus/BUFETS hybrid model? The key reason is to dispel the myth that there is any absolute accuracy for foundation heat transfer in EnergyPlus. The two-dimensional conduction-only model included in EnergyPlus (see Section 1) is rudimentary (even more so than the two-dimensional conduction model found experimentally to be inadequate [Robinson et al. 1990]) and does not capture the impacts of vapor-saturated soils that are typical in zone 6 and 7 climates. So replacing this model with a three-dimensional model that includes these missing physics is far more likely to approach absolute accuracy. Also, the intention is to be very clear about the apparent fiction that any earth contact simulation code (including BUFETS) currently can be considered “absolutely valid.” The literature currently does not include detailed three-dimensional datasets with full transient soil characterization on a fine enough spatial grid to perform an absolute validation with real credibility.

4.2 Physical Consistency

An assessment of physical consistency is a review of whether the simulation results display the expected results as a function of climate. For example:

- Increasing foundation heating season energy consumption with decreasing seasonal average temperature
- Decreasing energy consumption with increasing insulation thermal resistance, etc.

Such a review also allows apparently anomalous trends to be discovered that establish the need for additional experimental data.

The following discussion refers to sensible loads only. BUFETS does not model latent loads that, in the case of foundations, can be much larger than the sensible loads.

¹⁶ An analytic element description of the foundation system interior can be used to formally demonstrate this. This description yields a closed-form solution for the foundation system temporal interior temperature profile. A system meeting the stability criterion yields negative eigenvalues and therefore produces a stable result; a system violating the stability criterion yields positive eigenvalues and thus an unstable and physically meaningless result (see Goldberg 2010).

The comparison building was evaluated in all three simulation climates (Bemidji, Minnesota; Minneapolis, Minnesota; and Janesville, Wisconsin) for full basements and crawlspaces for all the insulation strategies in the test matrix (reported later in Table 7) as follows:

- No insulation
- R-5, R-10 and R-15 interior insulation
- R-5, R-10 and R-15 exterior insulation
- R-5, R-10 and R-15 interior insulation combined with exterior R-5 AG wall insulation.

(In the case of the crawlspace, the comparison building was identical to that shown in Figure 7, except the interior height was changed to 4.2 ft for Minneapolis and Janesville and to 5.7 ft for Bemidji. In all cases, the AG crawlspace wall height was 8 in. More importantly, the crawlspace was separately conditioned with the same AA160 (ANSI/ASHRAE standard 160, 2009) interior set point temperature profile used in both BUFETS and EnergyPlus.

The purpose of these simulations was to verify that:

- The trends of changing insulation and location were physically consistent within each climate and between climates.
- To confirm in absolute terms that the foundation system cooling sensible energy was small relative to the heating energy for the uninsulated case. This arises because of the close coupling between the basement and the ground (with an annual average temperature of 50°F or less for the cold climates included in this study). This earth tempering keeps the basement below the typical AG space cooling season temperature set points of 65°F or higher. The sensible cooling load is nominally zero, but to allow for the heat rejected by appliances and solar gain through the AG walls with a southern exposure, based on the FTF experimental data (Goldberg 2011), a value for the cooling/heating sensible energy ratio of less than 5% has been adopted for this analysis.¹⁷ This established a baseline metric for assessing the degree of divergence between the BUFETS and EnergyPlus interior foundation system temperatures in the subsequent BEopt model results analysis.

The absolute energy performance for Bemidji for the full basement is shown in Figure 10. The uninsulated cooling/heating energy ratio was 1.4%, well within the 5% limit. The cooling load increases for the exterior insulation placement only. The effect of insulation placement on basement cooling sensible loads in cold climates needs to be investigated further experimentally and numerically to understand this effect fully.¹⁸ The heating loads are fully consistent with the exterior insulation placement yielding the worst energy performance because of the “fin”

¹⁷ This is not true for latent loads. The loads in a basement can be quite substantial depending on the vapor transport resistance of the foundation insulation system (Goldberg 2011).

¹⁸ A possible explanation is the fin conduction effect from the warm AG envelope. This effect manifests experimentally for exterior insulation in terms of an increased heating load to the sub-slab soil (the “fin” effect). This suggests that a complementary effect to the AG envelope for the increased cooling load is a reasonable starting basis for future research.

conduction effect of having the walls encapsulated with insulation. The interior+exterior (IntExt) configuration produced the best performance, because it has the highest net thermal resistance.

INSULATION STRATEGY ENERGY COMPARISON FOR BEMIDJI, MN

Comparison Building Configuration with Full Basement

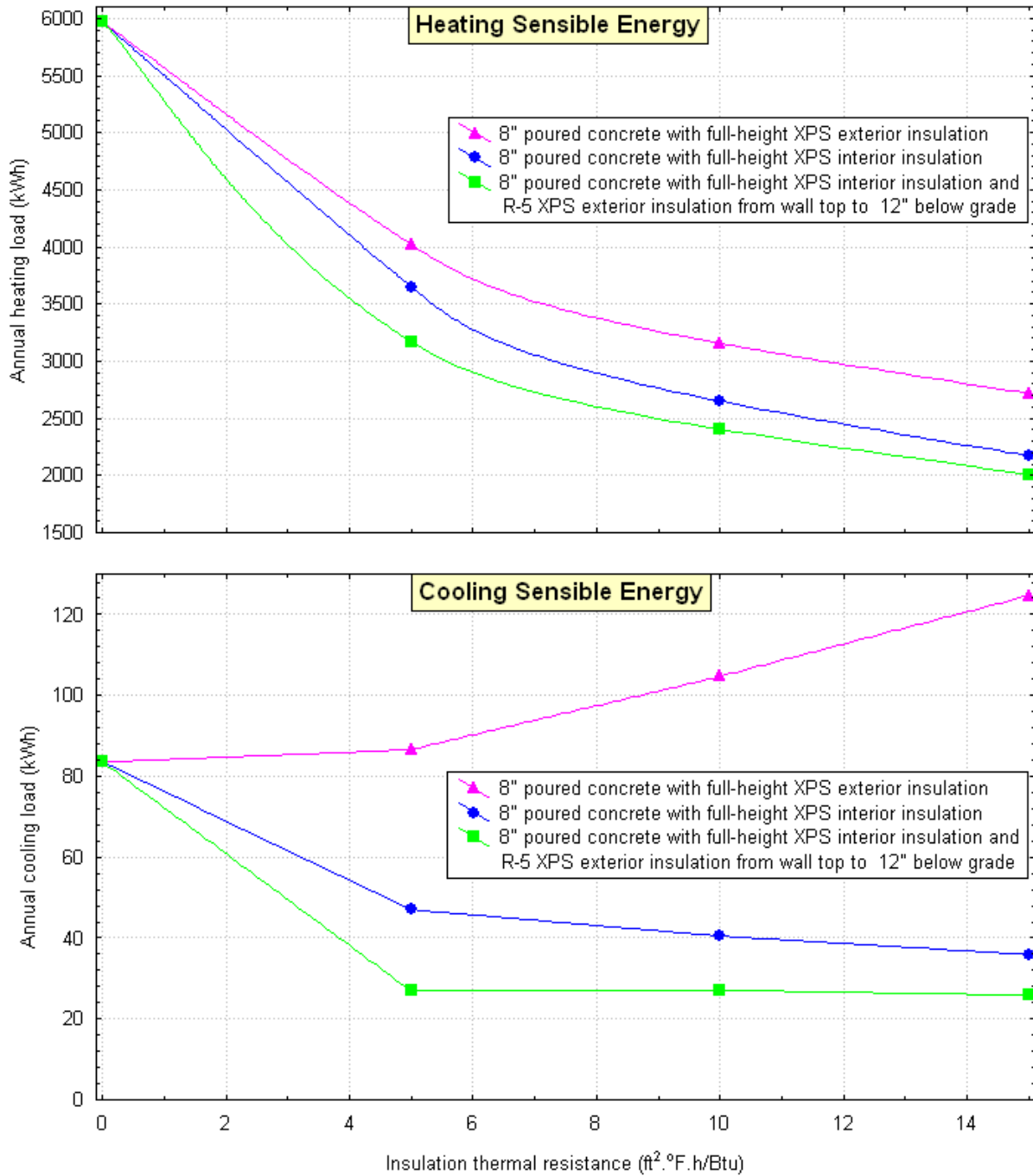

Figure 10. Absolute comparison building full basement foundation performance for Bemidji

These same trends are shown in Figures 11 and 12 for Minneapolis and Janesville, respectively. The uninsulated cooling/heating energy ratios were 2.1% for Minneapolis and 2.2% for Janesville, both within the 5% limit. Further, the absolute heating loads decreased, moving from Bemidji through Minneapolis to Janesville as required by the increasingly warmer climate. The cooling loads increased through the Bemidji to Janesville traverse for all the insulated cases; however, the uninsulated Minneapolis cooling load was larger than that of Janesville. The reasons for this exception are not known and could be a numerical artifact related to the weather file data.¹⁹

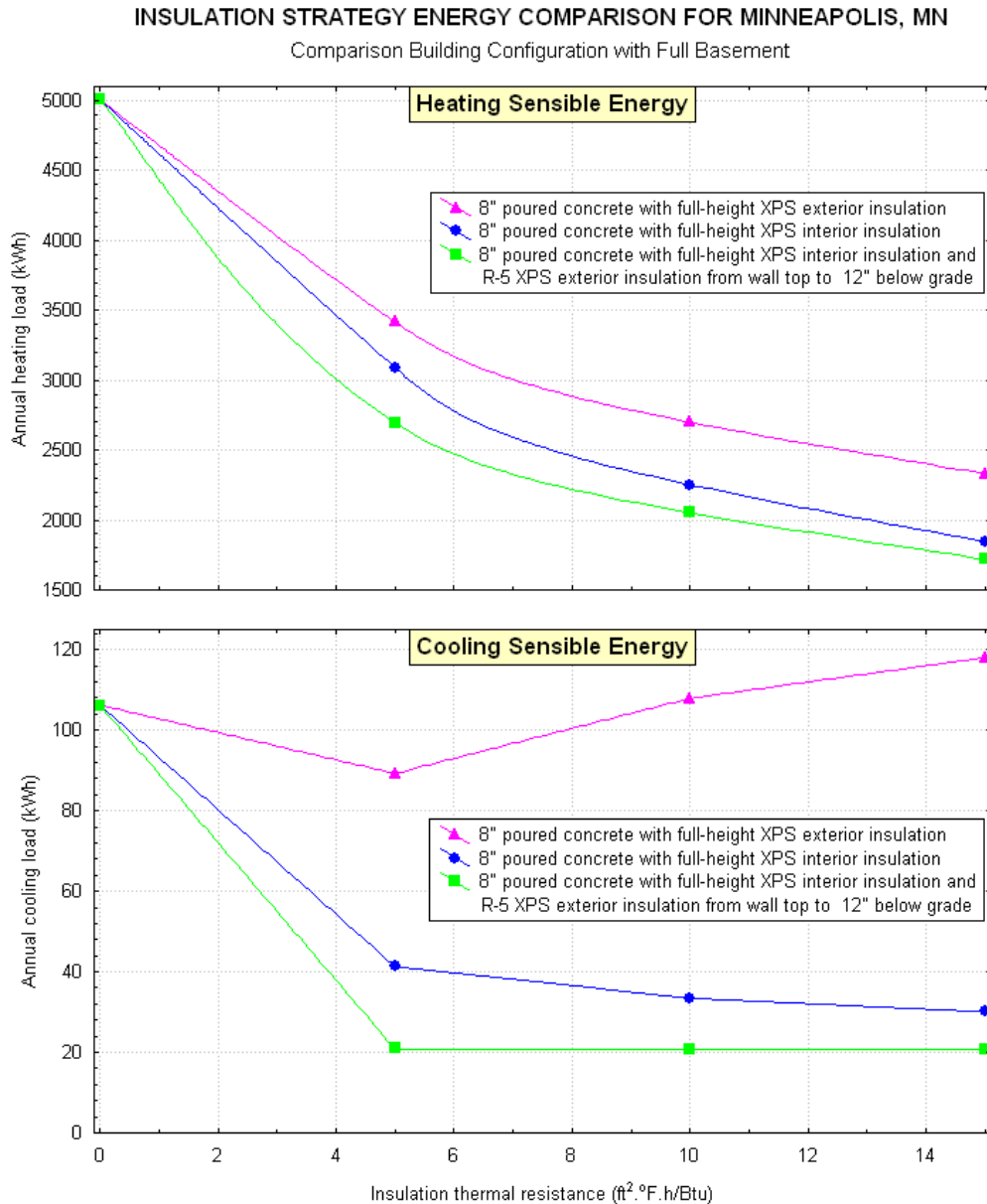

Figure 11. Absolute comparison building full basement foundation performance for Minneapolis

¹⁹ The .epw files are TMY3 files that are artificially constructed to represent “typical” annual weather conditions for any particular location from multiple years of recorded meteorological data. They thus can display somewhat artificial and inconsistent characteristics, particularly with regard to gradients at the splice points.

INSULATION STRATEGY ENERGY COMPARISON FOR JANESVILLE, WI
Comparison Building Configuration with Full Basement

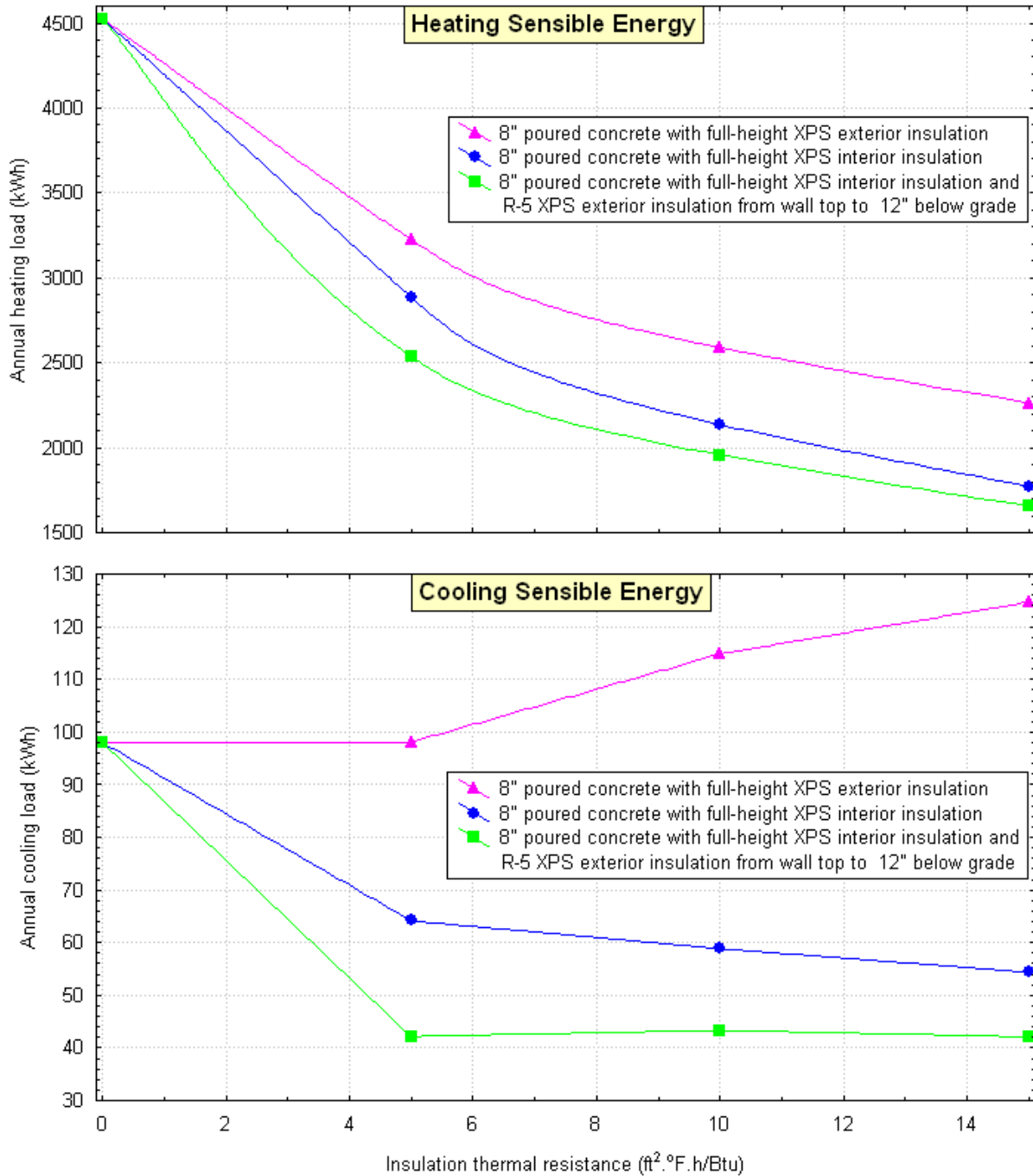

Figure 12. Absolute comparison building full basement foundation performance for Janesville

The balance of the physical consistency checks were based on the net space conditioning load (the sum of the heating and cooling loads), as this is the effective metric used in BEopt in

determining the whole-building energy performance. Figures 13 through 15 depict the annual heating and cooling load savings as functions of insulation thermal conductance and placement. The displayed patterns are physically consistent; the exterior insulation placement yields the lowest savings and the IntExt placement yields the highest savings.

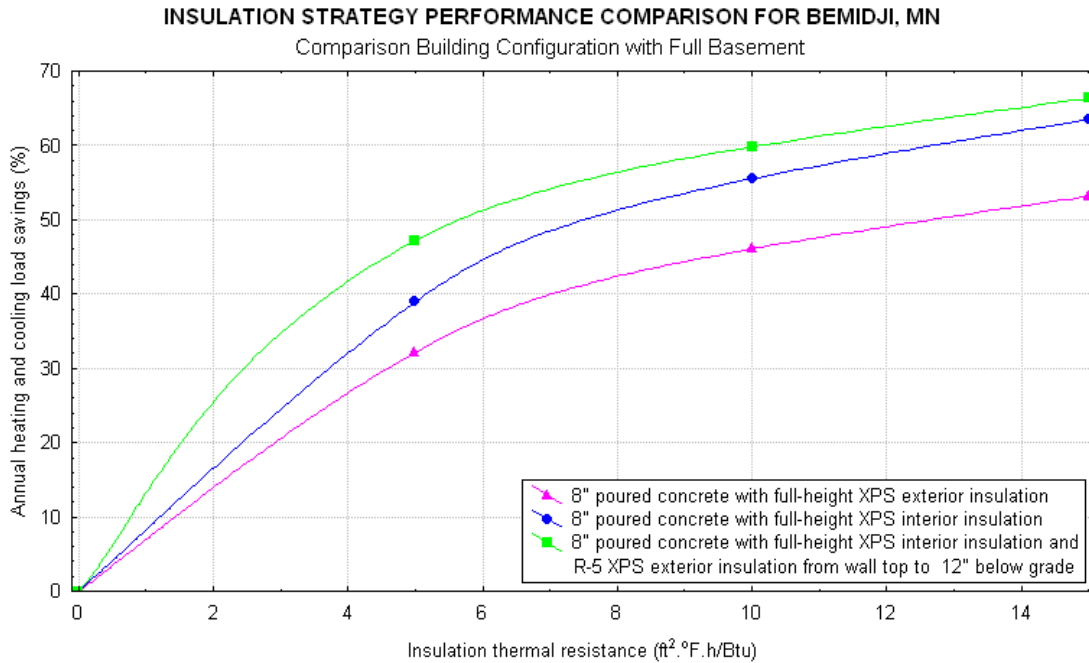

Figure 13. Annual full basement heating and cooling load energy savings for Bemidji

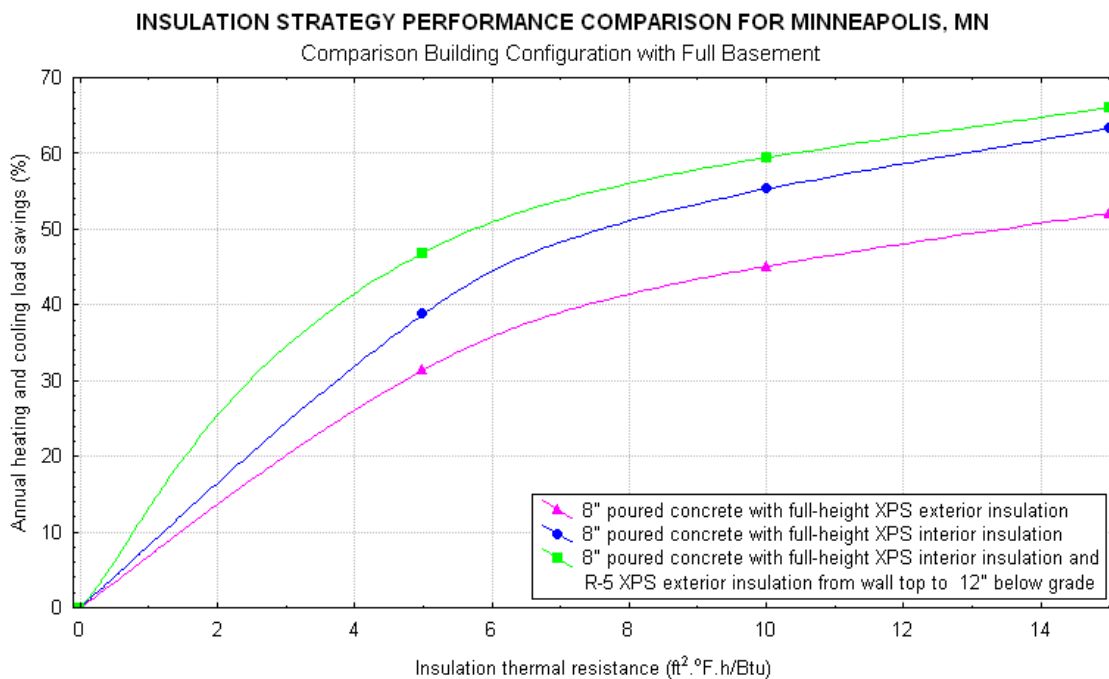

Figure 14. Annual full basement heating and cooling load energy savings for Minneapolis

INSULATION STRATEGY PERFORMANCE COMPARISON FOR JANESVILLE, WI
Comparison Building Configuration with Full Basement

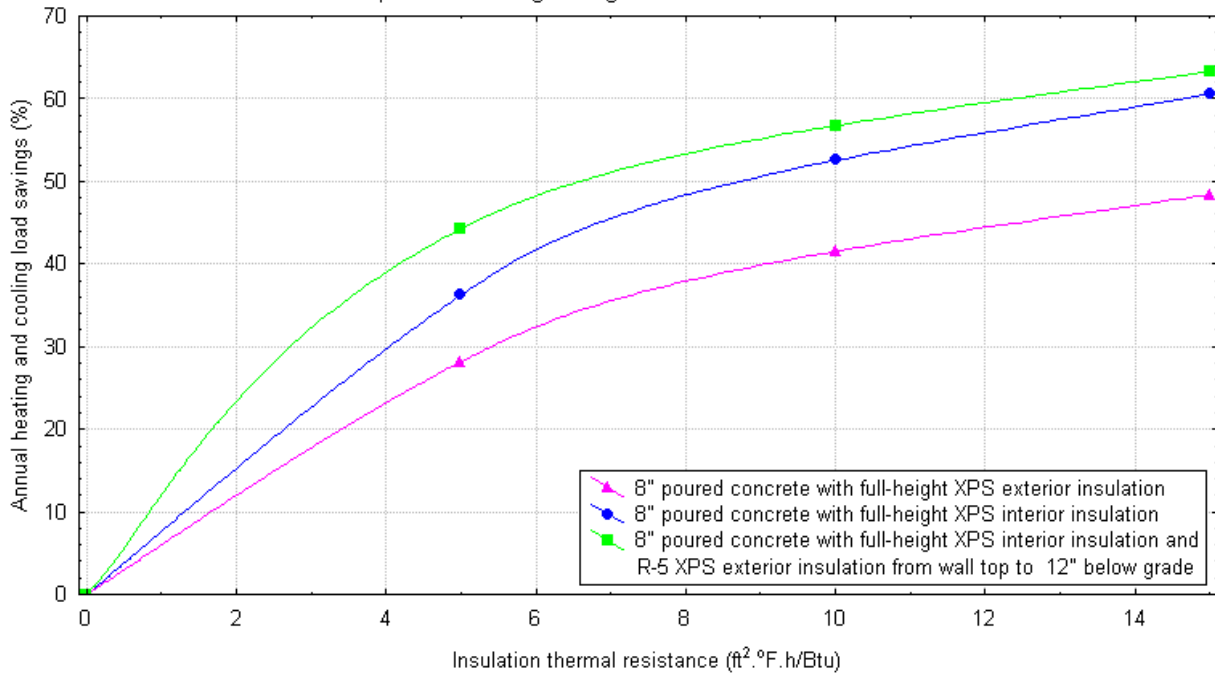

Figure 15. Annual full basement heating and cooling load energy savings for Janesville

For any particular insulation placement and thermal resistance, the pattern was consistent. The highest savings were shown for Janesville and the lowest for Bemidji; that is, the savings increase as the severity of the climate decreases as expected (higher levels of insulation are required as the heating load increases to maintain the same level of energy savings).

The performance of the single insulation placement (interior only) for the crawlspace foundation comparison building is shown in Figures 16 and 17. The uninsulated cooling/heating energy ratio was 1.0% for Bemidji, 1.7% for Minneapolis, and 2.1% for Janesville, all within the 5% limit. In absolute terms, the heating energy load decreased from Bemidji through Minneapolis to Janesville as expected; the cooling load also decreased with increasing thermal resistance in concert with the full basement interior insulation phenomenology. Janesville experienced the highest cooling loads; those for Minneapolis and Bemidji were comparable with foundation insulation and those for Minneapolis higher than Bemidji without insulation

CRAWL SPACE INSULATION STRATEGY ENERGY COMPARISON

Comparison Building Configuration with Footings at Code Frost Depth and Full-Height Interior XPS Insulation

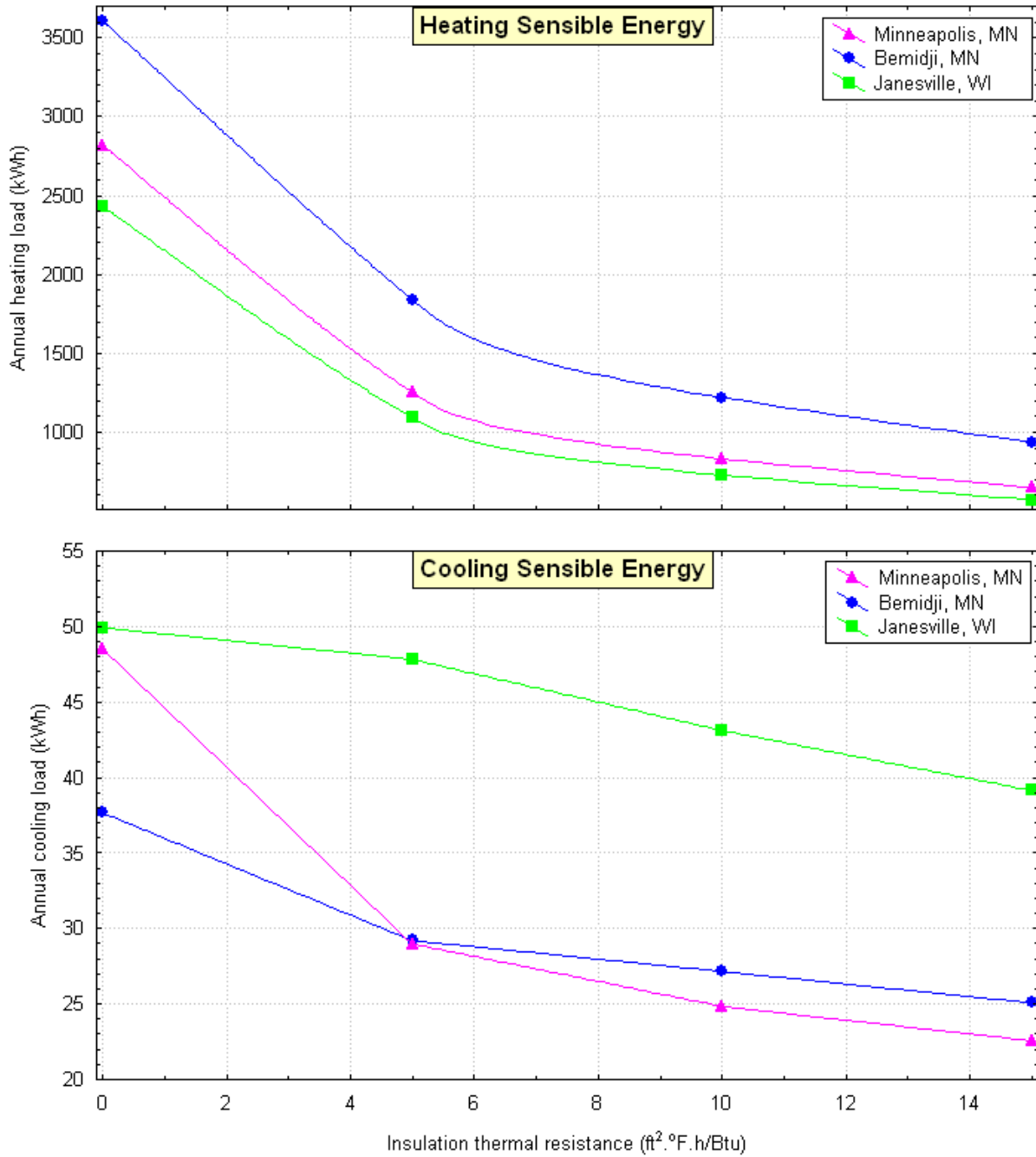

Figure 16. Absolute comparison building crawlspace foundation performance

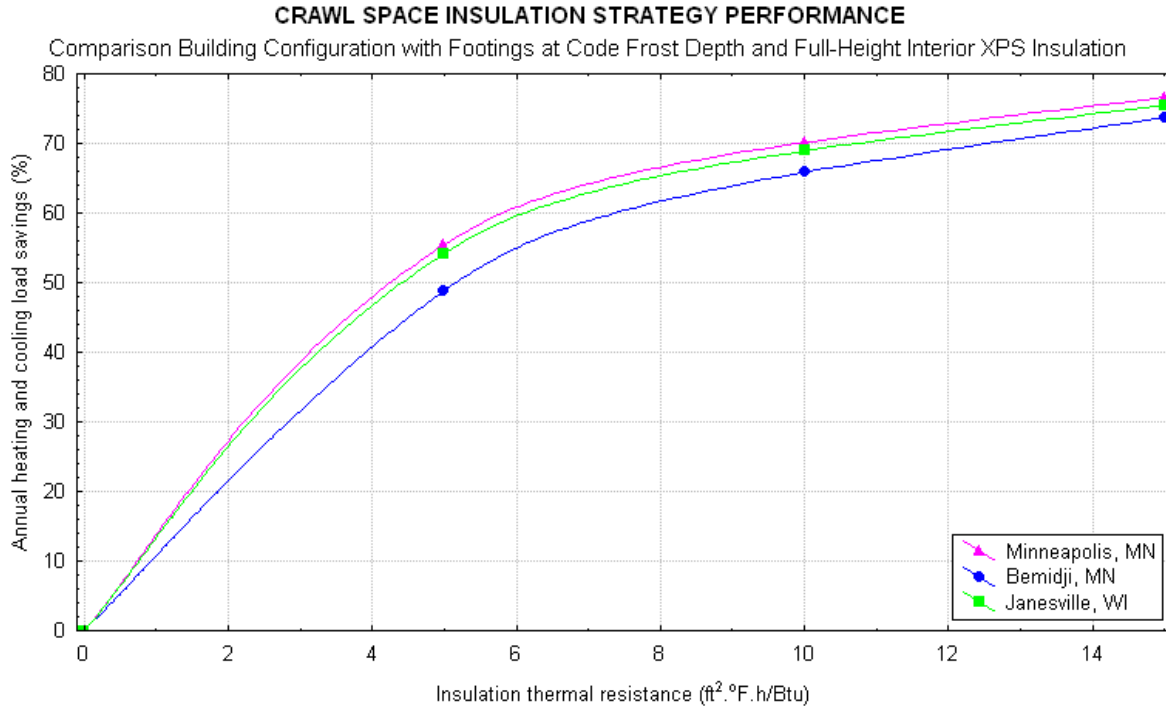

Figure 17. Annual crawlspace heating and cooling load energy savings

The annual heating and cooling load savings shown in Figure 17 for the crawlspace show the lowest savings for Bemidji and the highest for Minneapolis. The same is true for the full basement and is likely a consequence of the fact that, in aggregate, Minneapolis has a somewhat less severe climate than Janesville in TMY3 terms when both heating and cooling loads are considered.

These data show that the BEM is physically consistent with respect to comparisons by climate, insulation placement, and thermal resistance for sensible heating loads that predominate in climate zones 6 and 7. This is supported by the large amount of heating season experimental data gathered at the University of Minnesota’s FTF (Goldberg 2011). The sensible cooling load evaluation revealed some nonintuitive (although expected, see Section 1.1) results with regard to the impact of exterior insulation placement. These results need to be investigated further, both numerically and experimentally, even though there is a plausible explanation for these effects. Thus, the BEM is acceptable for relative comparisons of foundation heating load performance as a function of insulation thermal resistance in cold climates. But, at this stage, comparisons of sensible cooling load relative performance in cold climates cannot be made with the same level of confidence. Again, it needs to be emphasized that in all cases, by design, the model was used in its optimum form; that is, the BUFETS and EnergyPlus foundation system interior temperatures are identical.

The physical consistency and relative accuracy of the model for predicting foundation heating load relative performance have been demonstrated for an ideal configuration. Section 5 shows how the model performed when applied to a BEopt building model in which the temperature equality requirement was not maintained.

5 Application to BEopt Building Models

5.1 Target Houses

The full basement house is based on the consensus specification of the Minnesota Reference House (developed by Goldberg and Huelman 2005) that was used to develop the foundation rules in the 2009 Minnesota energy code (Minnesota Statutes 2009). The specification of the Reference House is reproduced in Table 6 and is in compliance with the provisions of the 2009 Minnesota Energy Code. This specification was translated into the BEopt model shown in Figures 18 and 19, allowing for the automatic envelope configuration features in BEopt. The specification was not followed with regard to the basement and only a full basement with no windows was modeled. In other words, the lookout basement configuration of Figure 18 was not adopted. Where necessary, custom library options were developed in BEopt to accommodate the required glazing to floor area ratios, ventilation rates, etc.

Table 6. Minnesota Reference House Specification

Characteristic	Specification
Housing Type	Detached, owner occupied
Net AG Footprint Size	2000 ft ²
Basement Size	1993 ft ²
Conditioned Space Size	3993 ft ² (Sheltersource 2002: 1998 median=4111 ft ² ; 2000 median=3827 ft ² ; Li2003 median= 3900 ft ²)
Cathedral Ceiling Floor Area	596 ft ²
Basement Configuration	Partitioned into 2 halves as follows: a. Full earth contact on all envelope walls. b. Graded berm on two walls, concrete knee wall with large windows in stud frame on third wall (daylight configuration).
Basement Conditioning	Each half separately zoned with 2 supply and 1 return ducts per half. Temperature allowed to float (that is, determined by 1 st floor thermostat)
Basement Zone Height	7 ft 8 in.
Grade Height	12 in. below wall top
Basement Glazing Area Ratio (Basement Floor Area Basis)	6%
Above Grade Story Zone Height	8 ft
Construction	AG: wood frame BG: poured concrete
AG Glazing Area Ratio (AG Floor Area Basis)	14%
Glazing	double
Window Types	50% double hung, 50% casement ^a
AG Glazing Distribution	15 rough openings with one window each; 3 rough openings with 3 windows each
Window Infiltration	Double hung: 0.07 cfm/ft ² Casement: 0.02 cfm/ft ²
No. of Swinging Exterior Doors (Excluding Glazed Doors)	3 (2 to exterior, 1 to garage)
No. of Glazed Sliding Patio Doors	1
Glazed Sliding Patio Door Infiltration	0.08 cfm/ft ²

Characteristic	Specification
Total Conditioned Space Infiltration	0.31 cfm/ft ² of conditioned space at 50 Pa (Sheltersource, 2002, 2000 home measured average)
Wall Infiltration	(Total infiltration)-(Σ window and door infiltration)
Exterior Cladding	Vinyl siding
Occupancy	3 people
No. of Bedrooms	3
No. of Bathrooms	2 full (sink, shower/bath, toilet), 1 half (sink, toilet)
No. of Other Rooms	5
Lot Size	0.41 acres
Major Equipment	Refrigerator, range, dishwasher, washing machine, clothes dryer, sink disposal, microwave oven, central air conditioning, water heater
Heating Plant	Forced air furnace
Main Heating Fuel	Piped gas (assumed to be natural gas)
Cooking Fuel	Electricity
Water Heating Fuel	Piped gas (assumed to be natural gas)
Air Conditioning Fuel	Electricity
Clothes Dryer Fuel	Piped gas (assumed to be natural gas)
Garage	Attached 2 car

^a Split systems are used to create a representative average of commonly used components or systems for calculation purposes even though they would not be used in practice.



Figure 18. Full basement BEopt model house

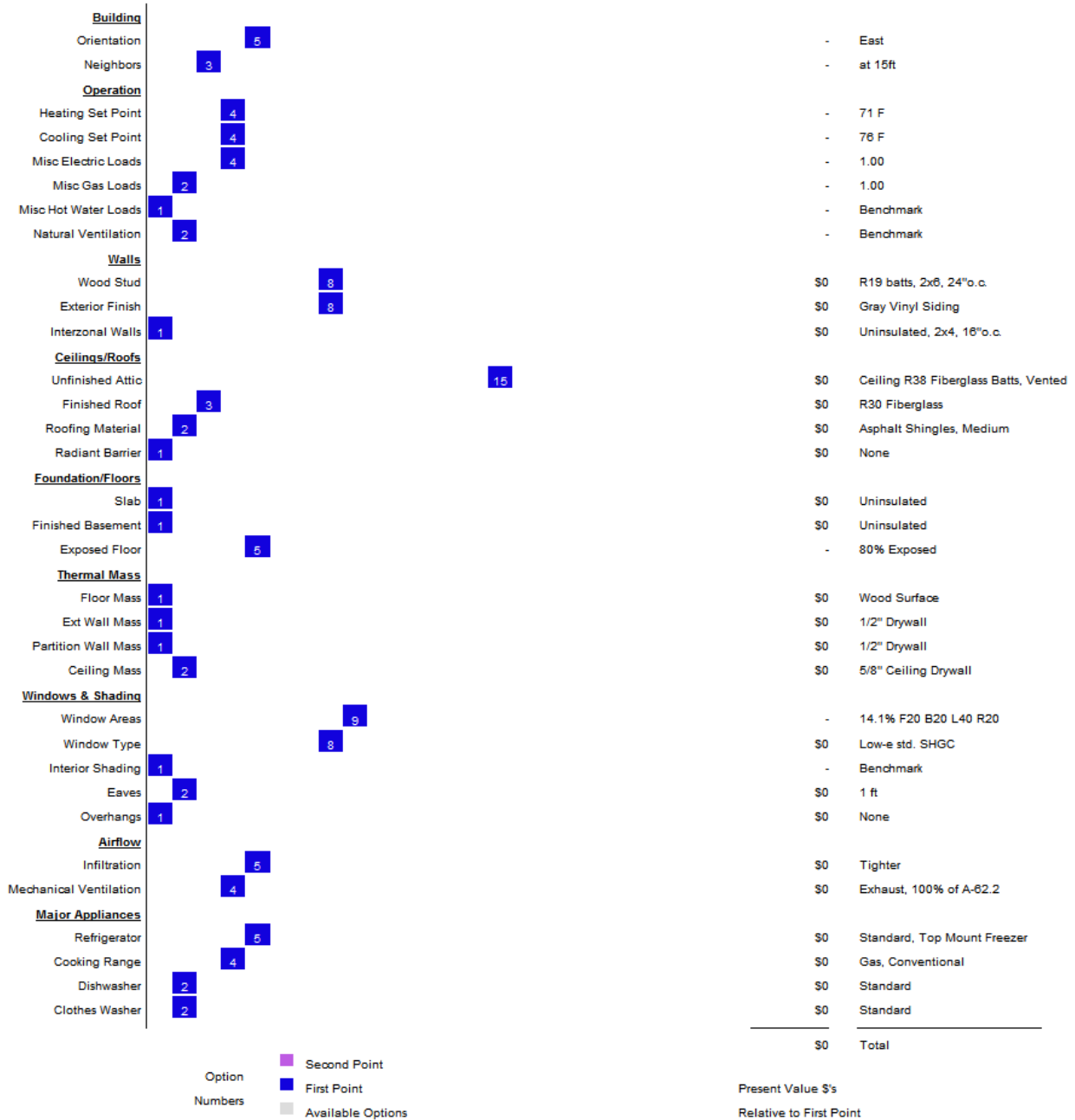

Figure 19. Full basement BEopt model house specification

The target crawlspace house specification is shown in Figures 20 and 21. Similar to the full basement house, this house also is in compliance with the 2009 Minnesota Energy Code. The house geometry is based on a rambler that is typical of the zone 6 and 7 crawlspace retrofit housing stock. Again, custom BEopt library options were developed to accommodate glazing to floor area ratios, ventilation rates, etc.

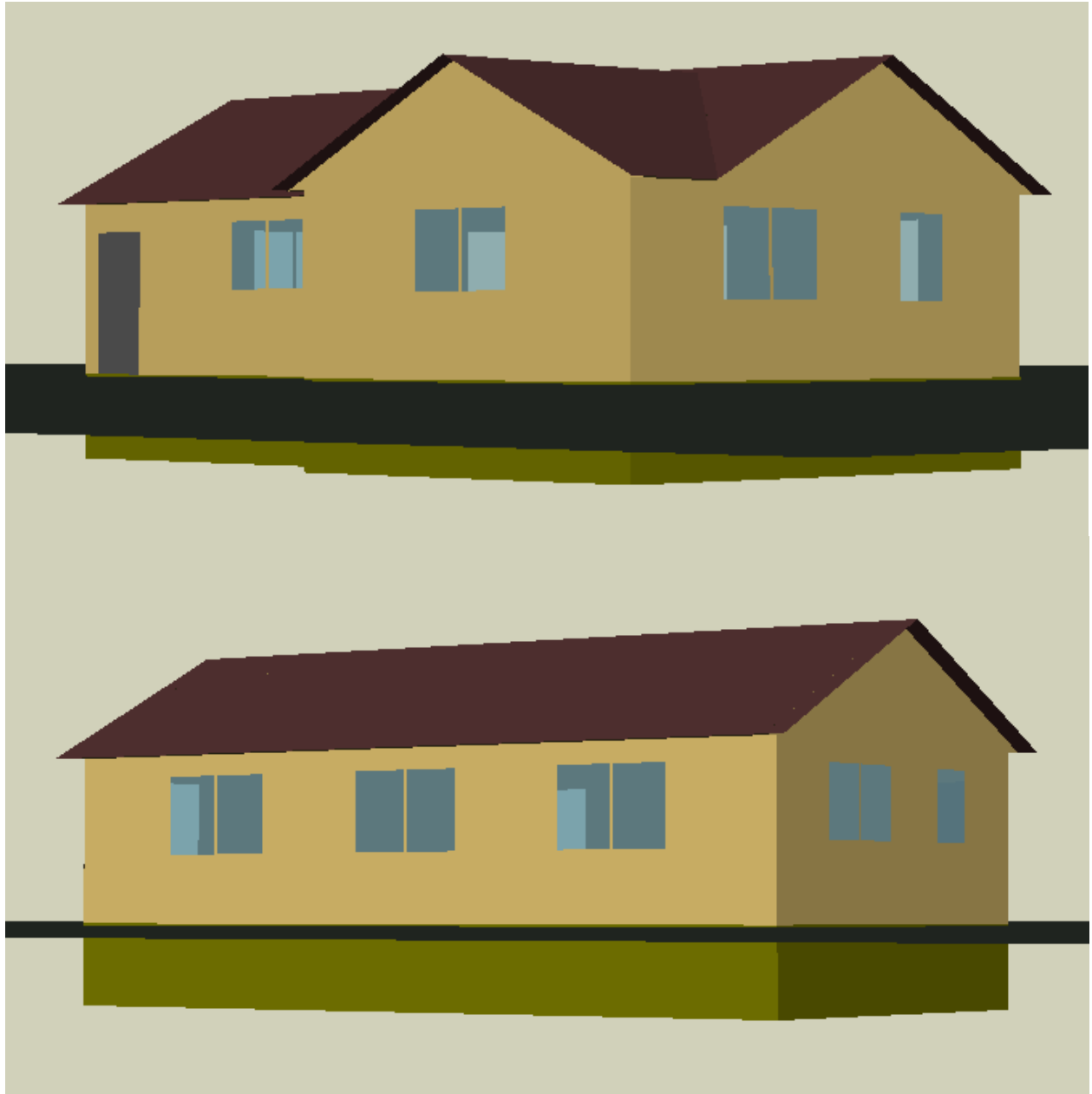

Figure 20. Crawlspace basement BEopt model house

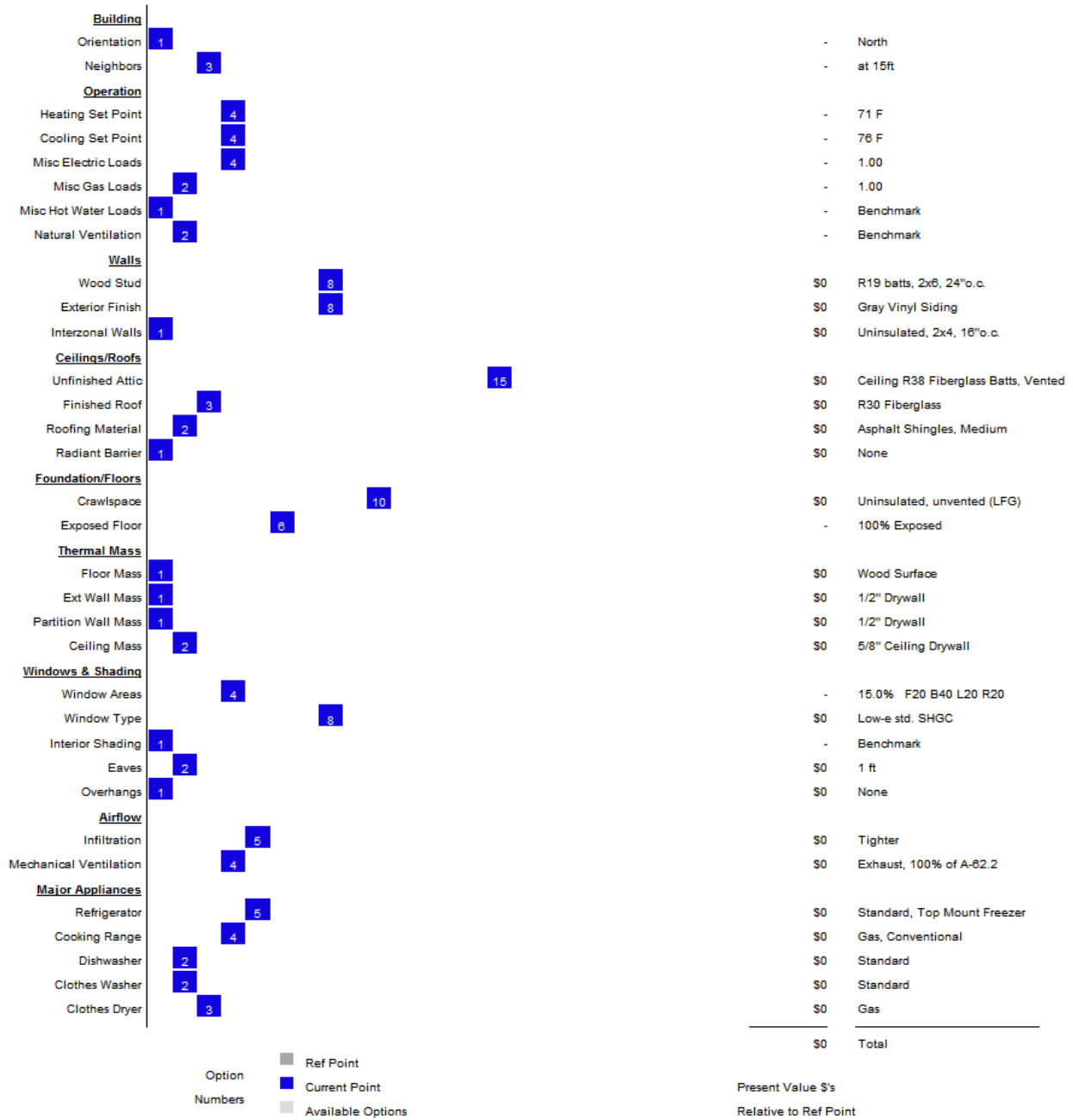

Figure 21. Crawlspace BEopt model house specification

The HVAC configuration was generated by BEopt (see Figure 22). A single unitary heat/cool furnace directs conditioned air via a zone splitter to the living and finished basement zones. The furnace is controlled by a thermostat linked to the living zone, which ensures that the finished basement zone has a floating temperature. As discussed previously, this configuration was not altered to a dual space heating plant configuration with an independent basement thermostat to

guarantee that the basement interior temperatures would be the same as those used in the BUFETS simulation.

The HVAC system design generated by BEopt is shown in Figure 23. This depicts a single unified heat/cool furnace connected to a single living zone. Thus the crawlspace foundation will experience a floating temperature. Again, the BEopt model was not modified to include a separately conditioned crawlspace zone to ensure that the crawlspace temperature profile was the same as that used in BUFETS.

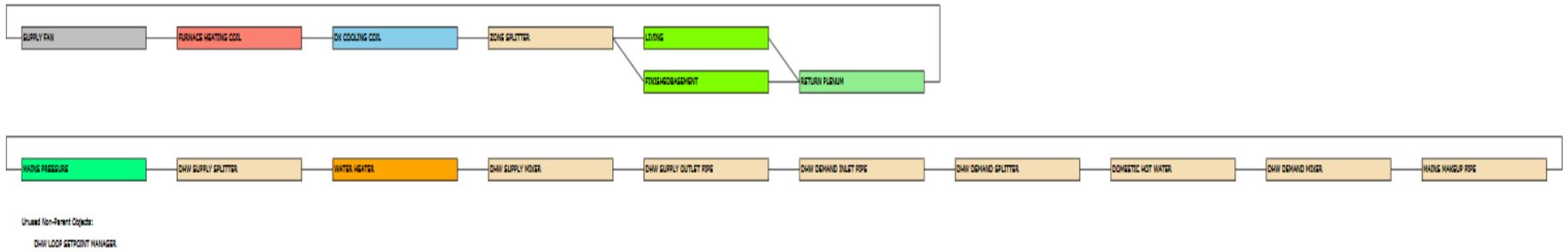

Figure 22. Full basement BEopt model house HVAC system configuration

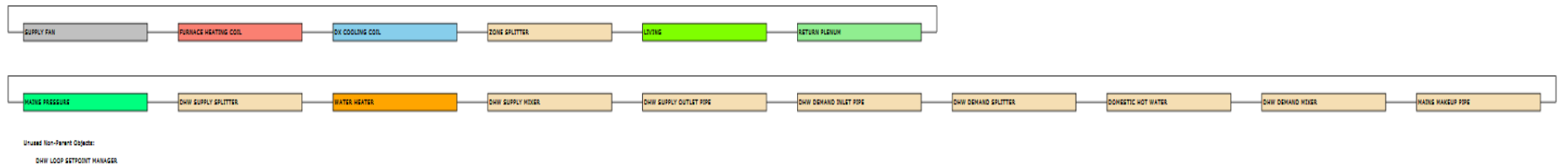

Figure 23. Crawlspace BEopt model house HVAC system configuration

5.2 Description of the Simulations

Table 7 shows three sets of simulations, which were carried out for each element of the full basement and crawlspace test house matrix, yielding 108 simulations. The first set was carried out entirely in BEopt and yields the results for the four insulation levels in the matrix without regard to insulation placement for a foundation system with BG only exposure (BEopt has no insulation placement option). The second set was carried out using the BEM for the all the insulation placements (three for the full basement and one for the crawlspace) and the four insulation levels in the test matrix for a foundation system with BG only wall exposure. The third simulation set repeated the second set except for a foundation with AGBG foundation wall exposure. In the third set, the AG exposure for the full basement was set at 12 in. and that for the crawlspace at 6 in., these being fairly typical for 2009 Minnesota Energy Code compliant construction. The relatively low levels of AG exposure also test the sensitivity of the BEM in showing the impacts of AG foundation wall exposure.

Table 7. Simulation Matrix

Foundation Type	Analysis	Climate	Insulation Placement												
			NonSpecific				Interior			Exterior			Int+Ext Top		
			R-0	R-5	R-10	R-15	R-5	R-10	R-15	R-5	R-10	R-15	R-5	R-10	R-15
Full Basement	BEopt	Bemidji	x	x	x	x									
		Minneapolis	x	x	x	x									
		Janesville	x	x	x	x									
	BEM: BG wall only	Bemidji	x				x	x	x	x	x	x	x	x	x
		Minneapolis	x				x	x	x	x	x	x	x	x	x
		Janesville	x				x	x	x	x	x	x	x	x	x
	BEM: AGBG wall	Bemidji	x				x	x	x	x	x	x	x	x	x
		Minneapolis	x				x	x	x	x	x	x	x	x	x
		Janesville	x				x	x	x	x	x	x	x	x	x
Crawlspace	BEopt	Bemidji	x				x	x	x						
		Minneapolis	x				x	x	x						
		Janesville	x				x	x	x						
	BEM: BG wall only	Bemidji	x				x	x	x						
		Minneapolis	x				x	x	x						
		Janesville	x				x	x	x						
	BEM: AGBG wall	Bemidji	x				x	x	x						
		Minneapolis	x				x	x	x						
		Janesville	x				x	x	x						

The detailed numerical results for all the simulations carried out are reported in Appendix A. A graphical summary is presented and discussed in the following sections. Each graphical dataset (except the one for Janesville) includes the following six graphs:

- Energy savings for foundation system (that is, the basement or crawlspace in isolation) heating and cooling energy. The basement annual heating and cooling energy savings for an insulated foundation wall compared with an uninsulated wall are plotted against the insulation thermal resistance as a function of insulation placement for basement walls with and without an AG component.
- Site energy savings for entire house. The site energy savings for an insulated wall compared with an uninsulated foundation wall are plotted against the insulation thermal resistance as a function of insulation placement for basement walls with and without an AG component.
- Source energy savings for entire house. The source energy savings for an insulated foundation wall compared with an uninsulated wall are plotted against the insulation thermal resistance as a function of insulation placement for basement walls with and without an AG component.
- For the full basement foundation only, the building energy distribution showing the energy distribution between the basement and living zones for the case with BG wall exposure only. The nonbasement annual heating and cooling energy savings arising from foundation wall insulation and the fraction of the whole house heating and cooling energy expended in the basement are plotted against the insulation thermal resistance as a function of insulation placement.
- For the full basement foundation only, the building energy distribution showing the energy distribution between the basement and living zones for the case with AGBG wall exposure. The nonbasement annual heating and cooling energy savings arising from foundation wall insulation and the fraction of the whole house heating and cooling energy expended in the basement are plotted against the insulation thermal resistance as a function of insulation placement.
- The absolute²⁰ foundation system heating and cooling energy. The basement annual heating and cooling energies are plotted separately against the foundation insulation thermal resistance as a function of the insulation placement.

The data to generate these graphics were extracted directly from the tabular results generated by EnergyPlus.

5.3 Full Basement Application for Janesville

Figure 24 shows the absolute energy performance of the full basement for Janesville. The graph reveals an absurd result for the BEM, namely that the heating energy consumption increases with insulation thermal resistance regardless of the insulation placement. In contrast, the raw BEopt

²⁰ Absolute energy refers to the energy used in GJ or kWh. Relative energy refers to the ratio of the energy used with a given level of foundation thermal insulation to that with no foundation thermal insulation.

results show the expected result of the heating energy consumption decreasing with insulation thermal resistance.

INSULATION STRATEGY ENERGY COMPARISON FOR JANESVILLE, WI

2-storey 2009 MN Energy Code Reference House with Full Basement:
Below-Grade Only Wall Exposure

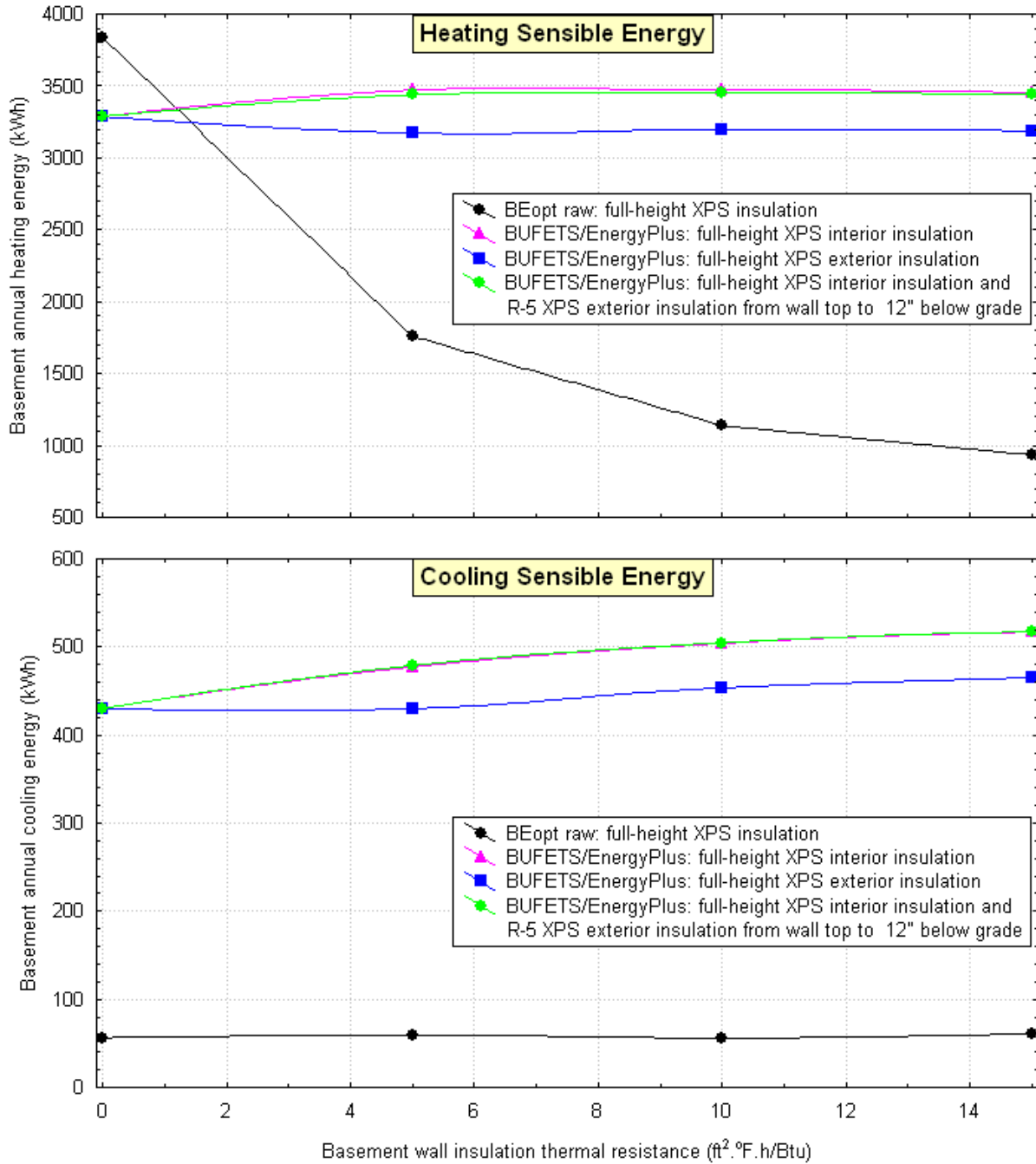

Figure 24. Absolute full basement energy consumption for Janesville

This is a classic case of model instability (see Figure 25). The fitted black profile in the upper chart reveals that with no insulation, the basement temperatures during the heating season are lower than or approximately equal to those of the living space. The BUFETS foundation interior set point temperatures are equal to those defined by the green profile for the living space. In this case, the BEM is stable and the result is reasonable. However, as soon as the insulation level is increased to at least R_{US-5} , as shown in the lower chart, the basement interior temperature exceeds that of the living space (and that used in BUFETS) making the BEM model unstable and thus producing the physically invalid result shown in Figure 24. As noted in Section 3.2, this situation requires that the BUFETS simulations be rerun using the warmer basement temperatures shown in Figure 25 for the R_{US-5} case (and individually for all the other cases) and iterated until foundation interior temperatures converge. However, given the time and budgetary constraints, the enormous amount of additional computation required could not be performed.

**BASEMENT AND LIVING SPACE MEAN TEMPERATURE PROFILES:
JANESVILLE, WI**

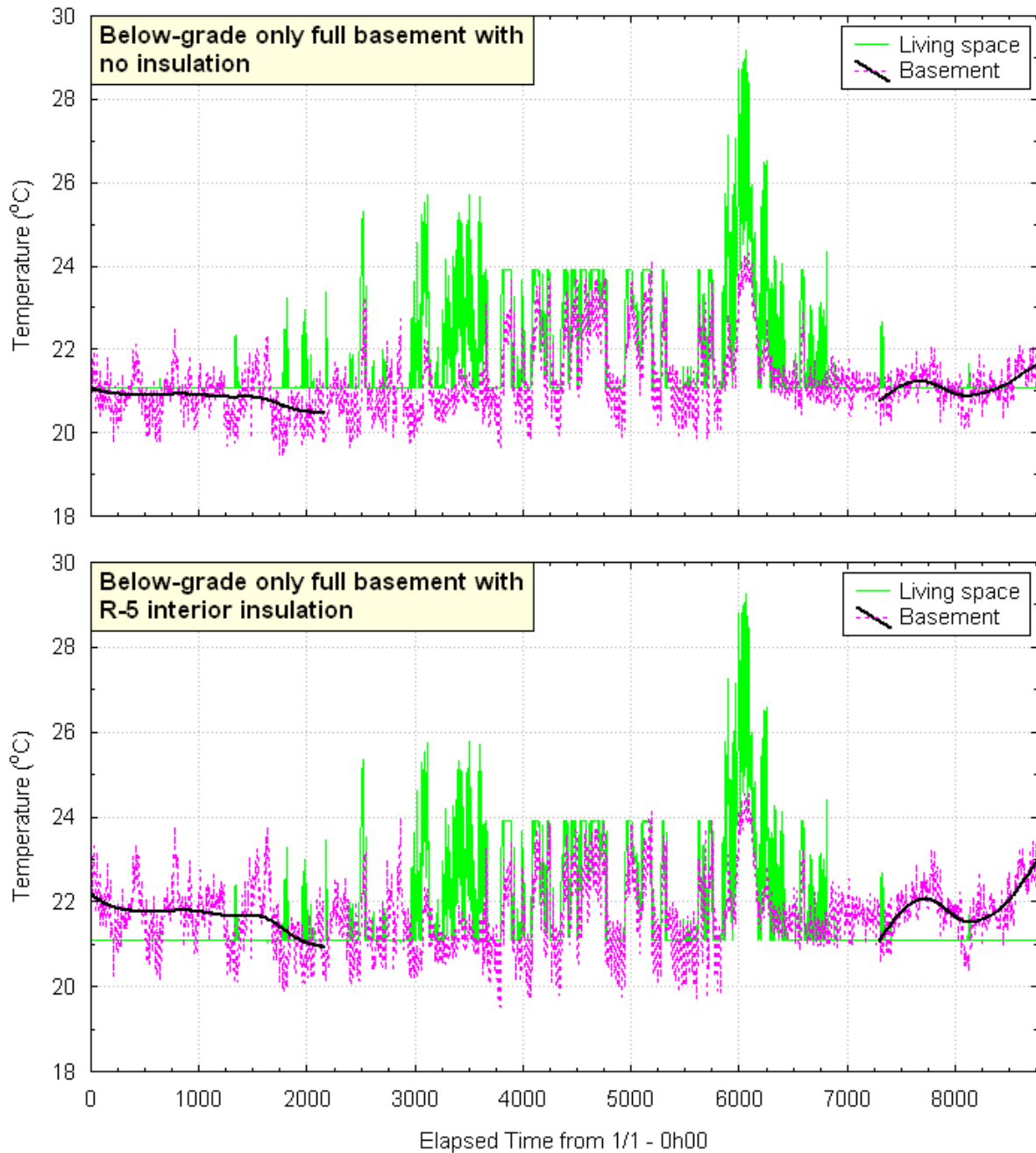

Figure 25. Full basement and living space temperature profiles for Janesville

This phenomenology as simulated by BEM, namely that adding foundation insulation increases the foundation temperature without producing significant energy savings, and in this case, driving the BEM model into instability was confirmed experimentally by Robinson et al. (1990).

As an alternative to the iterative run procedure, the effect of investigating the impact of lowering the basement interior temperature was demonstrated by simulating the Janesville building using the Madison climate (specifically, the Janesville foundation library was used for the simulation in a Madison climate).²¹ This nominally is a reasonable solution to ascertaining the foundation energy performance of a Madison house, because Janesville is only 33 miles southeast of Madison and thus has a fairly similar climate. The intention is to demonstrate that slightly decreasing the basement floating temperature is sufficient to restore stability to the BEM.

The impact of lowering the basement temperatures is shown in Figure 26. Now both the uninsulated and R_{US}-5 interior insulated cases clearly show basement interior temperatures lower than those of the living space (and those used in BUFETS), yielding a stable BEM simulation with generally physically reasonable relative performance results, with some exceptions. In this case, however, the absolute results are not relevant and are thus not shown.

²¹ This topic warrants detailed investigation. The procedure adopted is only an approximate substitute that was possible within the budgetary constraints.

**BASEMENT AND LIVING SPACE MEAN TEMPERATURE PROFILES:
MADISON, WI**

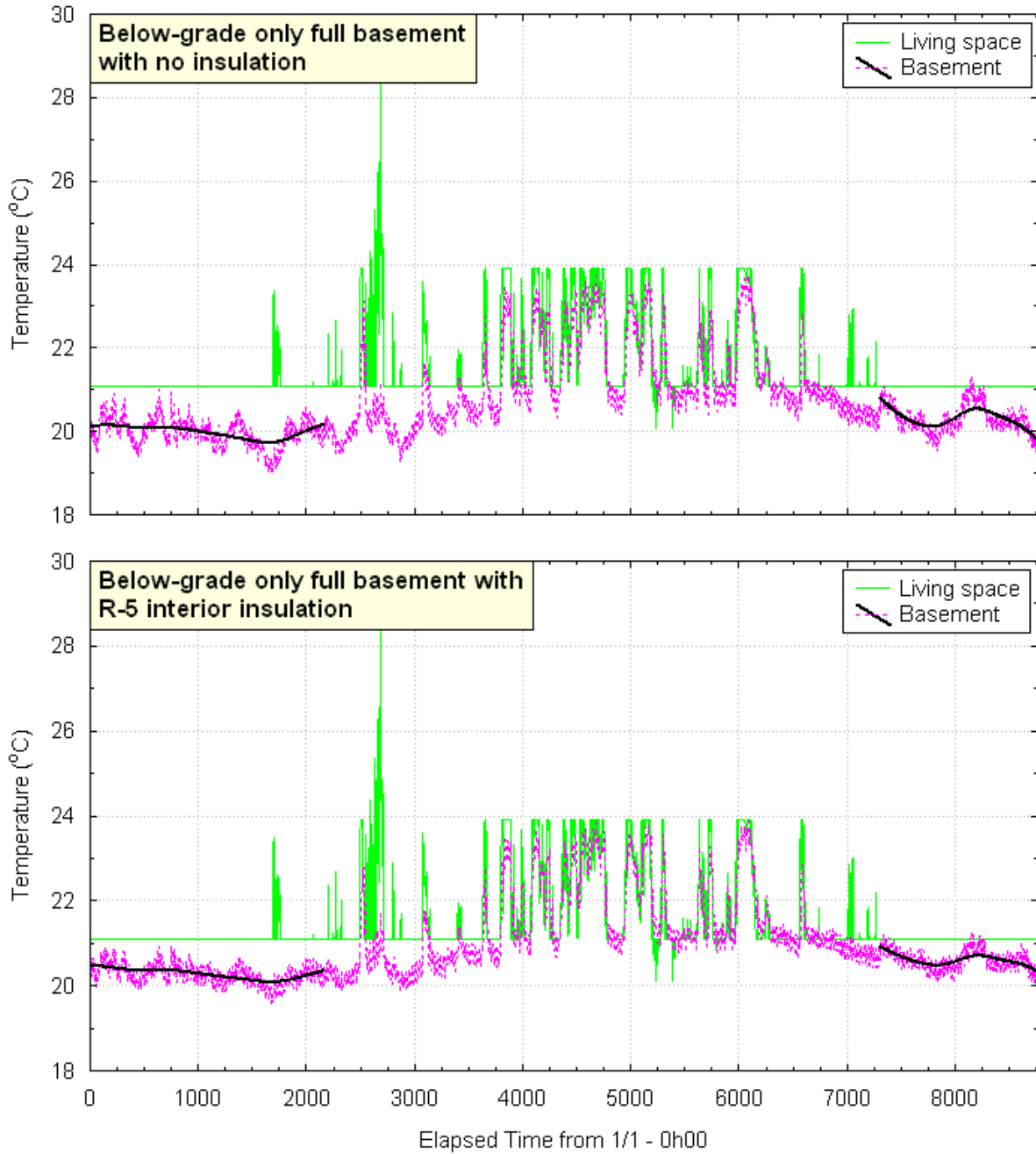

Figure 26. Full basement and living space temperature profiles for Madison generated using the Janesville foundation library

The results for the Madison climate using the Janesville foundation library are depicted in Figures 27 through 31. Figure 27 shows the energy savings for the basement as a function of insulation placement and thermal resistance. As expected from the comparison building results,

the savings achieved by the IntExt placement are the greatest, followed by the interior and exterior placements. The stability of the BEM becomes marginal at the R_{US-15} level for the two placements with interior insulation, even with the Madison climate, because the energy savings are less than those at R_{US-10} (shown by the dashed lines). This effect is not apparent for the exterior insulation placement. Thus at R_{US-15} , the basement interior temperature again exceeds that of the living space. In the BG only foundation wall exposure case shown in the upper panel, a direct comparison between the BEopt and BEM savings is possible. The BEopt savings are consistently larger than the interior and exterior insulation placements (there currently is no provision in BEopt for modeling the IntExt placement case). The difference is about 12% for exterior insulation and 16% for the exterior insulation.

**INSULATION STRATEGY PERFORMANCE COMPARISON FOR MADISON, WI
USING JANESVILLE, WI FOUNDATION LIBRARY**

2-storey 2009 MN Energy Code Reference House with Full Basement

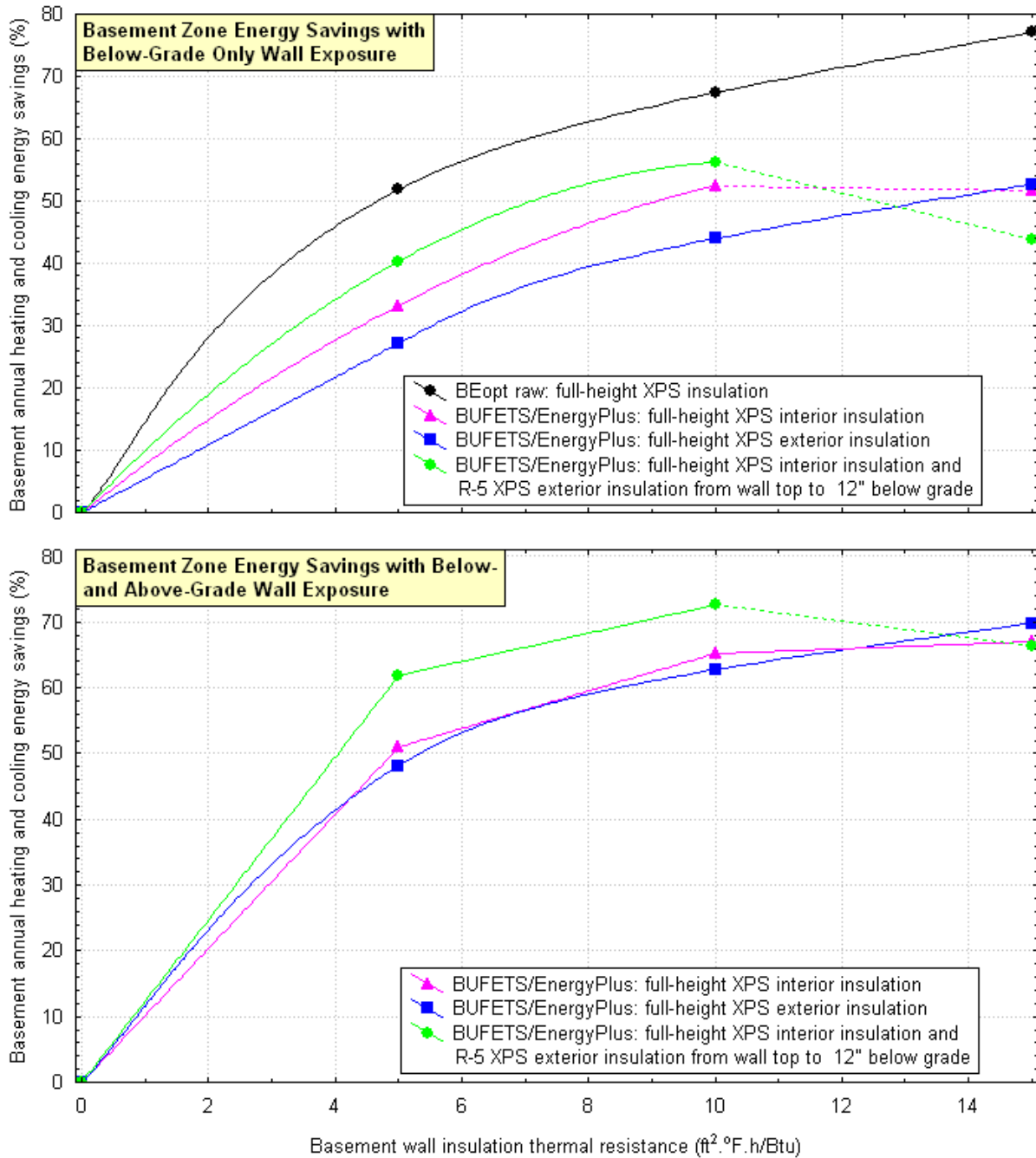

Figure 27. Basement heating and cooling energy savings for Madison

**INSULATION STRATEGY SITE ENERGY PERFORMANCE COMPARISON FOR
MADISON, WI USING JANESVILLE, WI FOUNDATION LIBRARY**

2-storey 2009 MN Energy Code Reference House with Full Basement

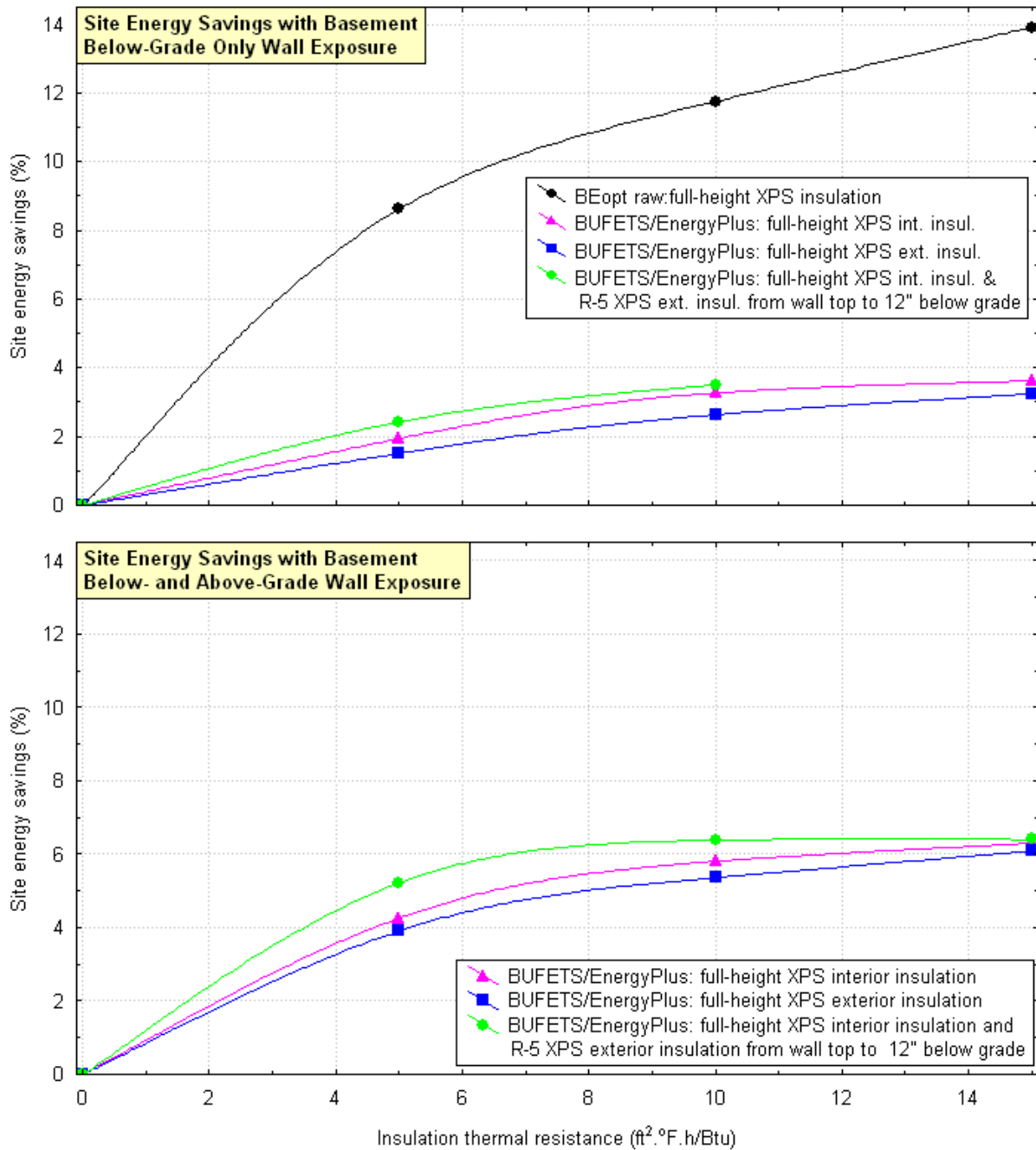

Figure 28. Site energy savings produced by foundation wall insulation for Madison

INSULATION STRATEGY SOURCE ENERGY PERFORMANCE COMPARISON FOR MADISON, WI USING JANESVILLE, WI FOUNDATION LIBRARY

2-storey 2009 MN Energy Code Reference House with Full Basement

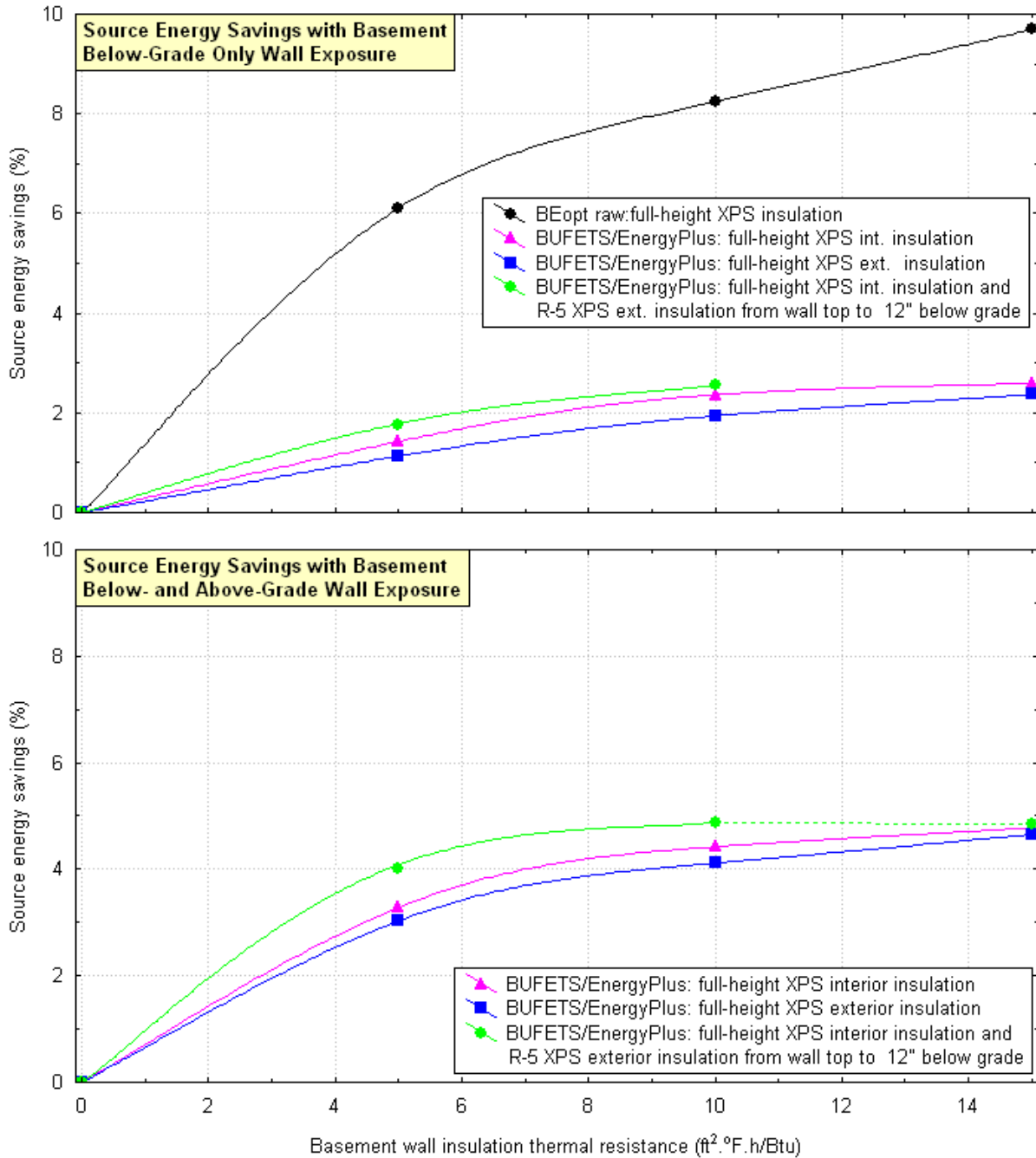

Figure 29. Source energy savings produced by basement foundation wall insulation for Madison

**BUILDING ENERGY DISTRIBUTION FOR MADISON, WI USING
JANESVILLE, WI FOUNDATION LIBRARY:
BASEMENT WITH BELOW-GRADE ONLY WALL EXPOSURE**
2-storey 2009 MN Energy Code Reference House with Full Basement

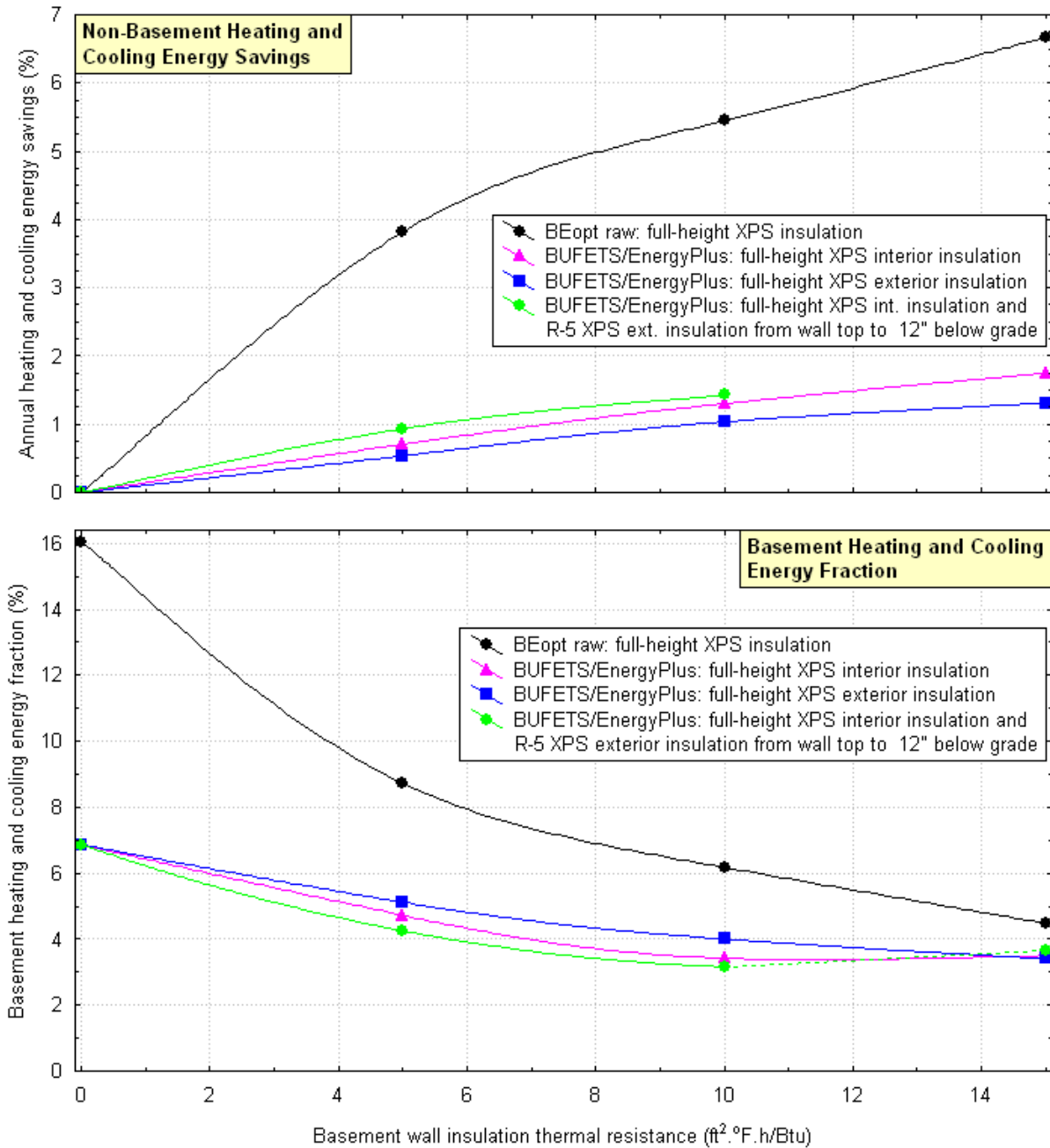

Figure 30. Building energy distribution for a basement with BG only wall exposure for Madison

**BUILDING ENERGY DISTRIBUTION FOR MADISON, WI USING
JANESVILLE, WI FOUNDATION LIBRARY:
BASEMENT WITH BELOW- AND ABOVE GRADE WALL EXPOSURE**
2-storey 2009 MN Energy Code Reference House with Full Basement

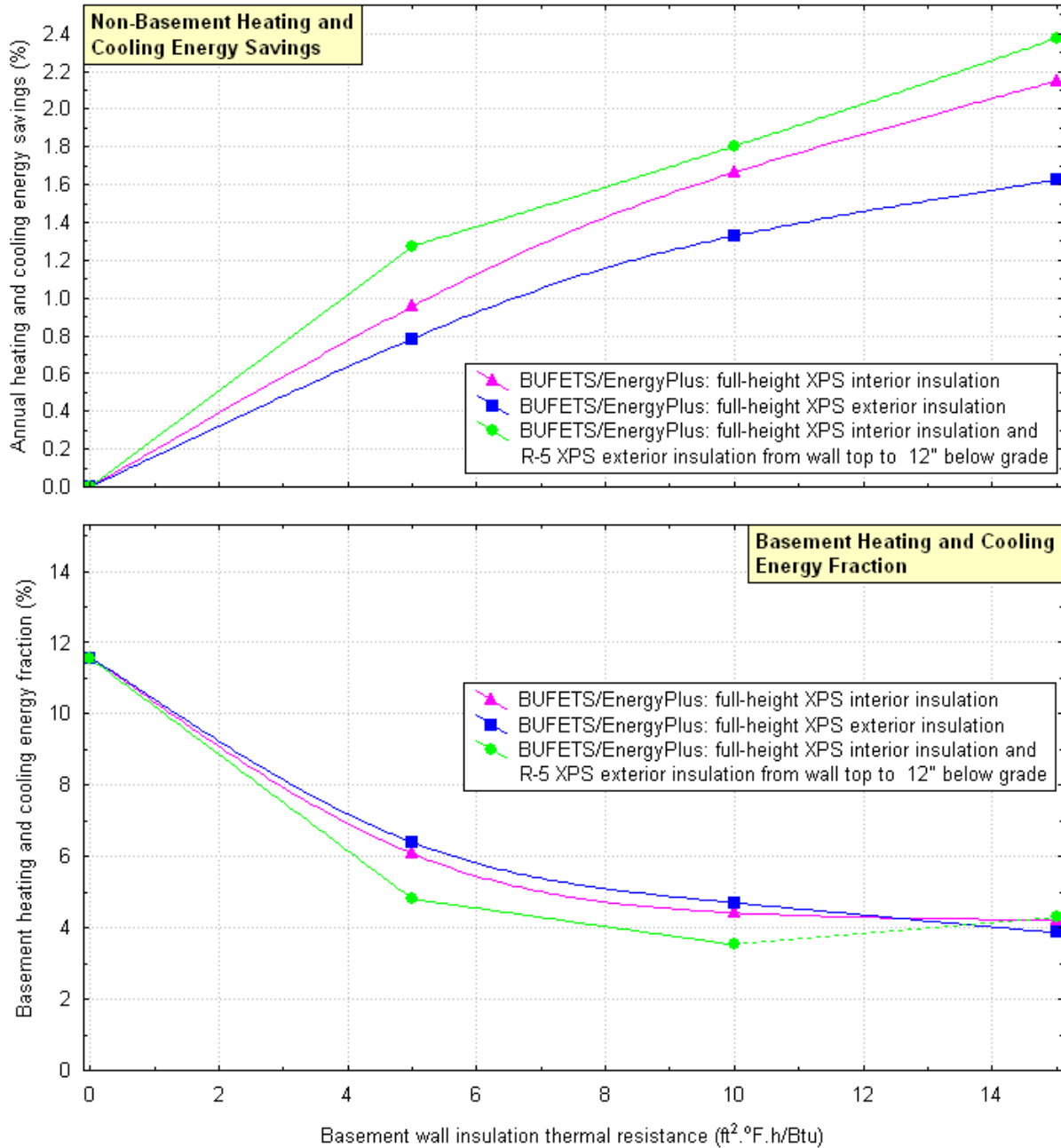

Figure 31. Building energy distribution for a basement with AGBG wall exposure for Madison

The lower panel of Figure 27 with AGBG foundation wall exposure shows generally higher savings than the BG case. The small difference between the interior and exterior insulation placements is not consistent with the comparison results (Figure 12), in which the interior

insulation yields notably and consistently better performance for all climates. This is a consequence of the nonlinear impact of AG wall exposure, because the wall exposure of the comparison building was 6 in. greater than that of the BEopt building.

Figure 28 depicts the site energy savings for the BG and AGBG configurations. In the BG case, BEopt predicts considerably higher site energy savings than BEM, as much as 10% higher for R_{US-15} insulation. The AGBG site energy savings are greater than those for the BG case because of the impact of the AG foundation walls. Figure 29 shows a similar pattern for the source energy savings with BEopt producing about a 7.5% larger savings for R_{US-15} insulation.

Figures 30 and 31 investigate the energy savings in the living zone realized from foundation insulation as well as the heating and cooling energy distribution between the living and basement zones for the BG and AGBG cases, respectively. The top panel of Figure 30 shows that BEopt yields a 5% larger living zone energy savings than BEM; the lower panel shows that with no foundation insulation, BEopt predicts that 16% of the heating and cooling energy is consumed by the foundation compared with only 7% by BEM. At R_{US-15} , this difference narrows to 1%.

Figure 31 shows that for the AGBG case, BEM yields a maximum living zone savings of 2.4% with R_{US-15} IntExt insulation; the basement energy fraction ranges from 11.5% with no insulation to 4% with R_{US-15} insulation.

Even though significant basement energy savings are possible with foundation insulation (70% or greater), given the low fraction of total space conditioning energy apparently consumed by the basement, these savings do not manifest in the BEopt source energy rating metric. This is in fact consistent with experimental findings in a cold climate, specifically Minnesota (Robinson et al. 1990) for a mix of basements with floating temperatures with and without sealed, forced-air heating ducts. These data showed that the average whole-house site energy savings for interior retrofit basement insulation averaged 7.9% (range of -0.6% to 17.8%). These results agree with those produced by BEM in Figure 28 for Madison (as well as for Minneapolis and Bemidji, Figures 33 and 39, respectively) in terms of magnitude (which is within the experimental ranges). Also, it is clear that the BEopt predictions (upper panel of Figures 28, 33, and 39) tend to be on the high end of the experimental data range. Two mechanisms can explain these results:

- An overprediction of the savings by BEM rooted in the limitations of the EnergyPlus foundation model (see Section 3), including two-dimensional simulation, use of monthly average ground temperatures, absence of phase change modeling, and the use of soil properties that are not dependent on the soil moisture content (for example, a wet soil can have a thermal conductivity many times greater than a dry soil).
- An underprediction of the savings by BEM caused by the interior surface fluxes generated from the coupling mechanism being too low arising from the mismatch between the floating EnergyPlus and fixed BUFETS interior boundary temperatures.

BEopt likely overpredicts the site energy savings, but clearly it is significantly more accurate than a previous attempt (Labs et al. 1988). These data indicate that for a 55 ft × 28 ft single-story house in a Minneapolis climate with a conditioned full basement, full-wall (8 ft) R_{US-10} interior insulation reduces the site energy heating load by 36%.

Therefore, the low whole-house energy savings accrued from foundation insulation retrofits imply that foundation insulation from the perspective of saving energy only (there are other compelling reasons for insulating foundations regardless of the energy savings) may not be cost effective until the energy consumption of the AG envelope is substantially reduced.

The BEM instability manifested only for the Janesville full basement simulation. The remaining full basement and crawlspace simulations all yielded stable BEM simulations with no inconsistencies.

The data patterns discussed in this section are repeated in the balance of the full basement simulations for Minneapolis and Bemidji and will not be discussed again in as much detail. Only the differences or divergences from the established patterns will be discussed in more depth in Sections 5.4 and 5.5.

5.4 Full Basement Application for Minneapolis

The full basement performance with BEopt and BEM for the Minneapolis climate is shown in Figures 32 through 37. For the BG case, the top panel of Figure 20 shows a much closer correlation between the basement energy savings of BEopt and BEM. Generally, BEopt predicts 10% higher savings (in absolute terms) for the interior and exterior cases and very similar savings for the IntExt case. In all cases, the rate of increase of savings decreases logarithmically with thermal resistance so that the largest proportion of the savings is attained with the first R-5 of insulation. In the lower panel, the AGBG configuration yields the highest savings for the IntExt case of 75% at R_{US-15} with similar and lower savings for the interior and exterior placements as in Janesville. As noted previously, this is likely related to the smaller AG exposure height of 12 in. for the model house compared with the 18-in. exposure for the comparison building, indicating a nonlinear relationship. In other words, the relative advantage of interior insulation decreases with decreasing AG exposure.

INSULATION STRATEGY PERFORMANCE COMPARISON FOR MINNEAPOLIS, MN

2-storey 2008 MN Energy Code Reference House with Full Basement

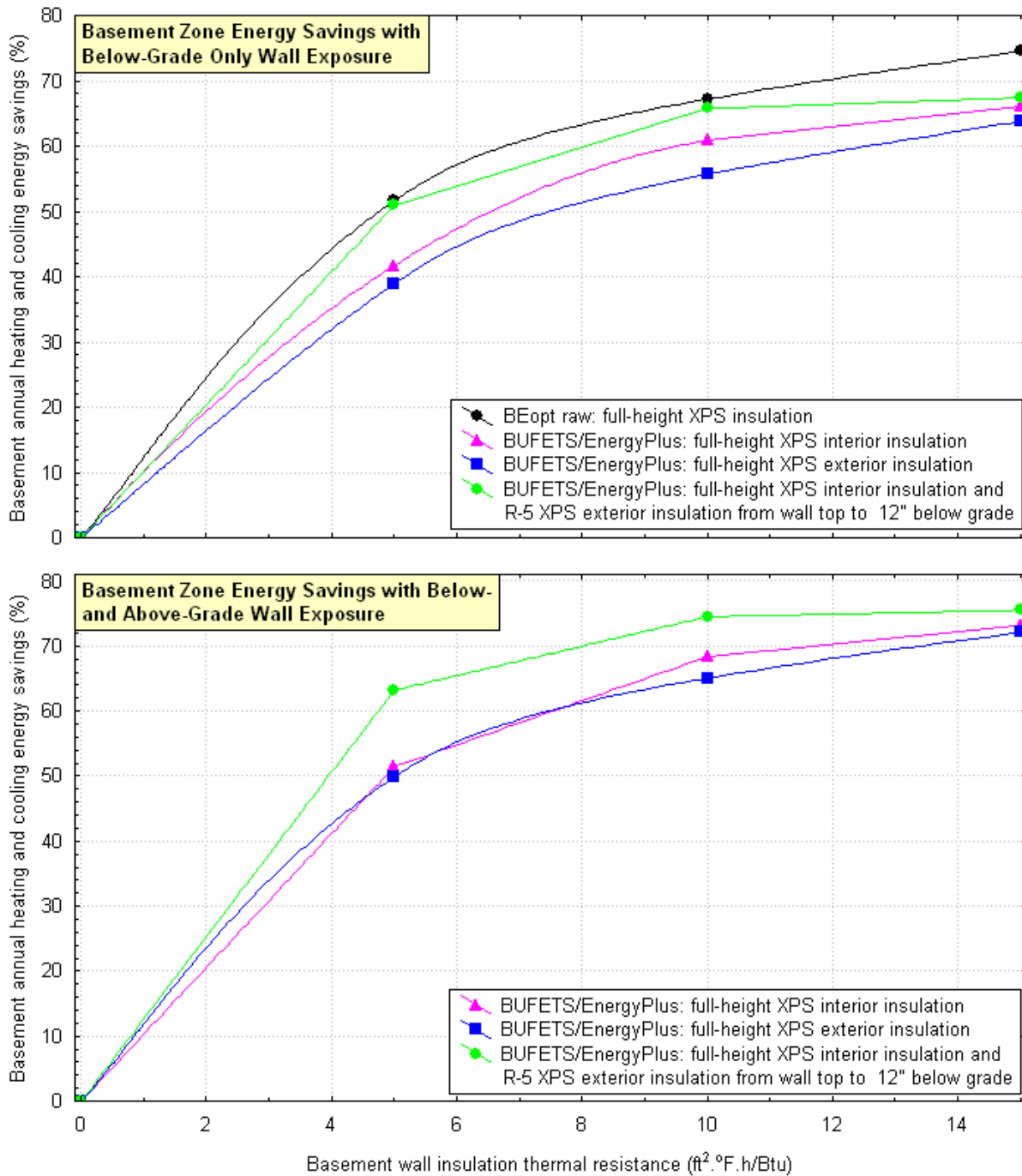

Figure 32. Basement heating and cooling energy savings for Minneapolis

INSULATION STRATEGY SITE ENERGY PERFORMANCE COMPARISON FOR MINNEAPOLS, MN

2-storey 2009 MN Energy Code Reference House with Full Basement

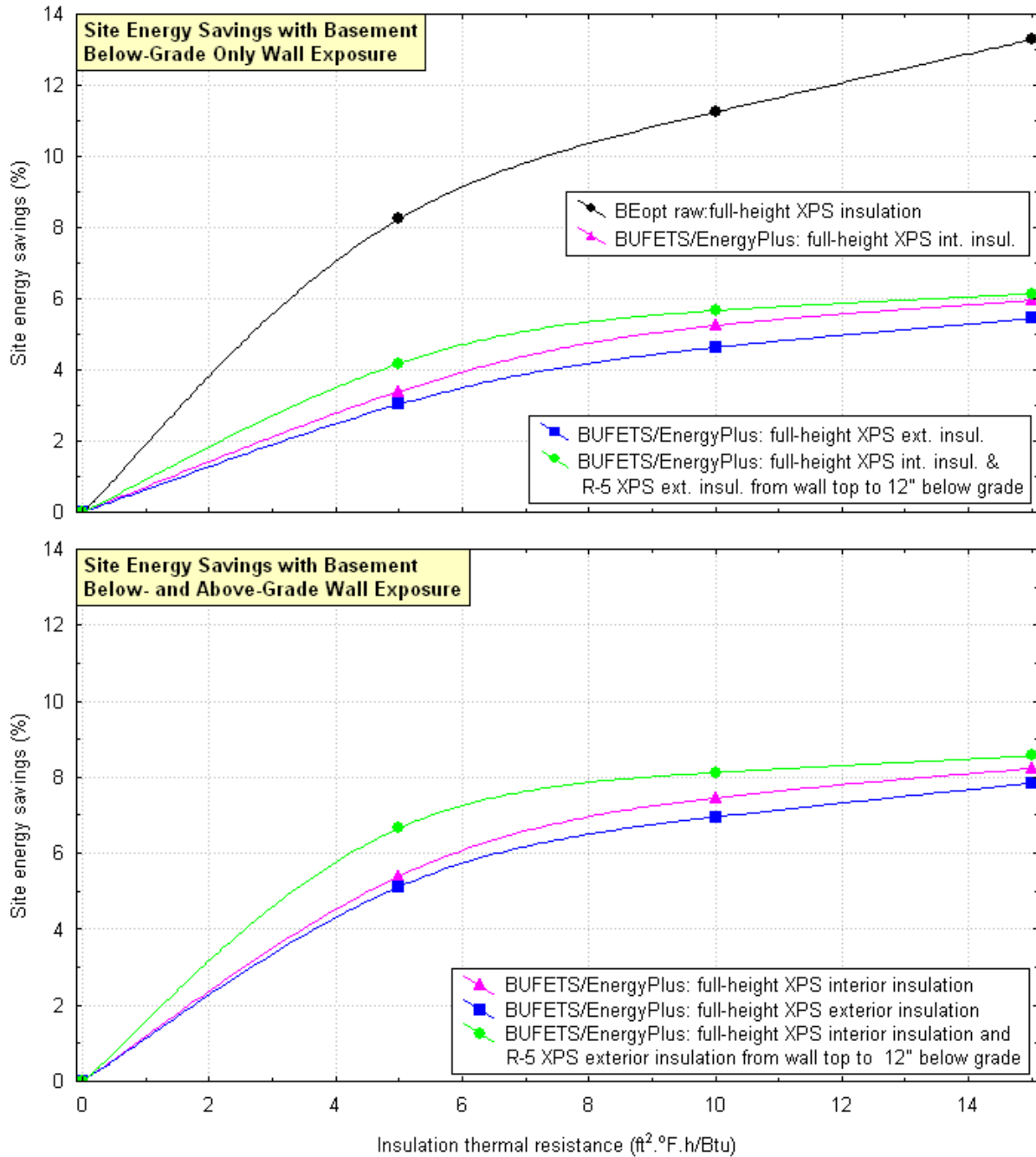

Figure 33. Site energy savings produced by basement foundation wall insulation for Minneapolis

INSULATION STRATEGY SOURCE ENERGY PERFORMANCE COMPARISON FOR MINNEAPOLIS, MN

2-storey 2009 MN Energy Code Reference House with Full Basement

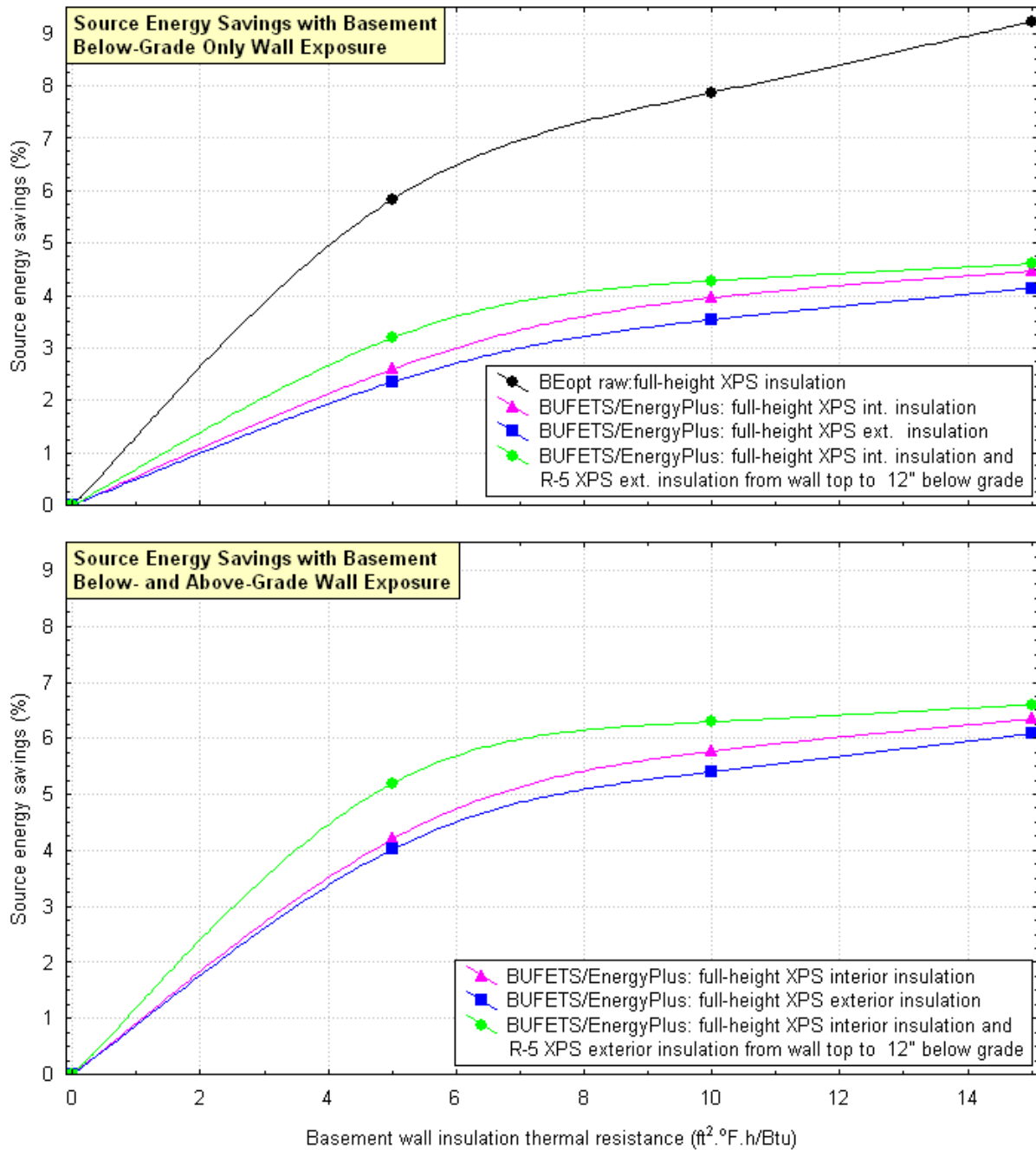

Figure 34. Source energy savings produced by basement foundation wall insulation for Minneapolis

**BUILDING ENERGY DISTRIBUTION FOR MINNEAPOLIS, MN:
BASEMENT WITH BELOW-GRADE ONLY WALL EXPOSURE**

2-storey 2009 MN Energy Code Reference House with Full Basement

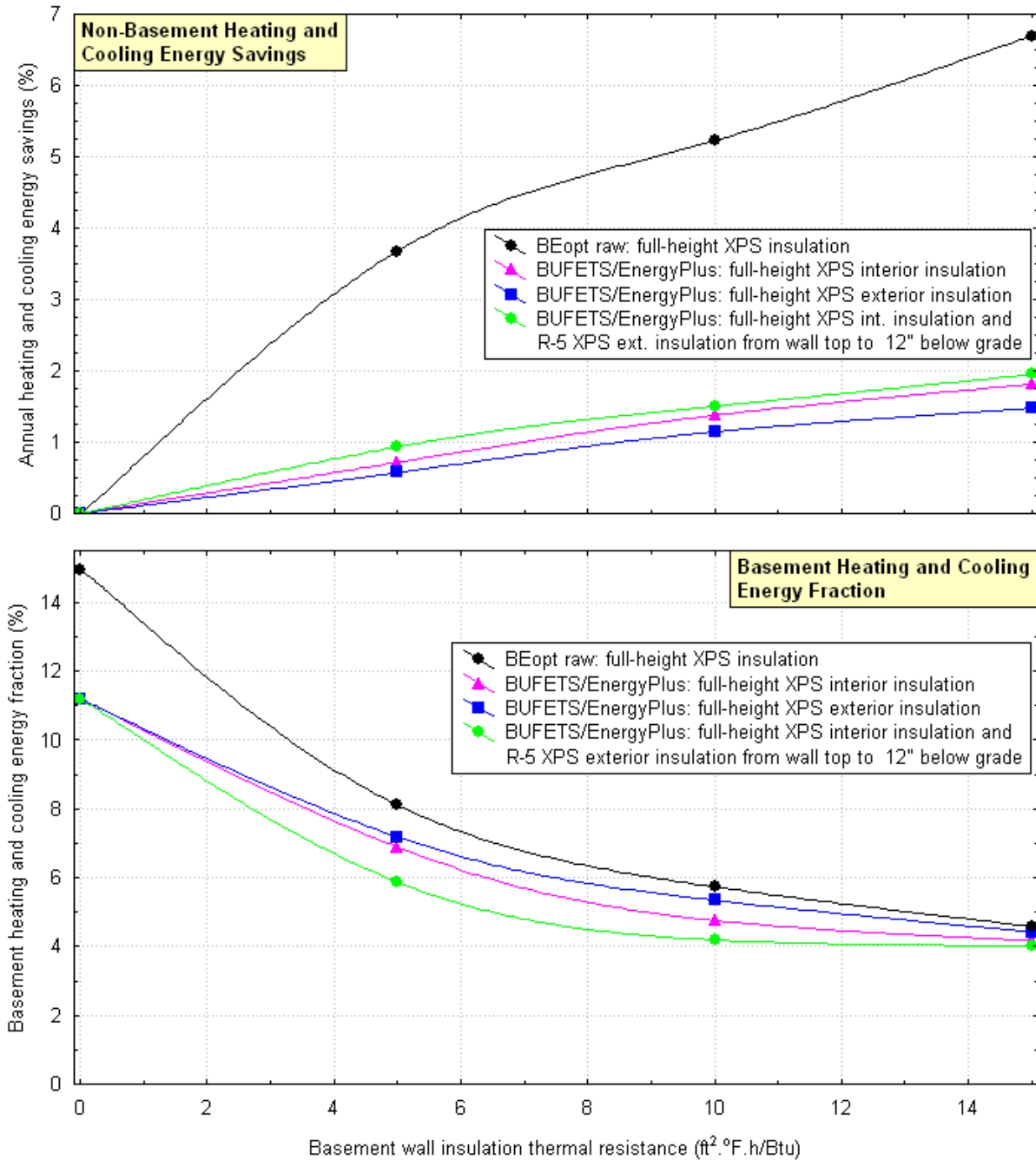

Figure 35. Building energy distribution for a basement with BG only wall exposure for Minneapolis

**BUILDING ENERGY DISTRIBUTION FOR MINNEAPOLIS, MN:
BASEMENT WITH BELOW- AND ABOVE GRADE WALL EXPOSURE**

2-storey 2009 MN Energy Code Reference House with Full Basement

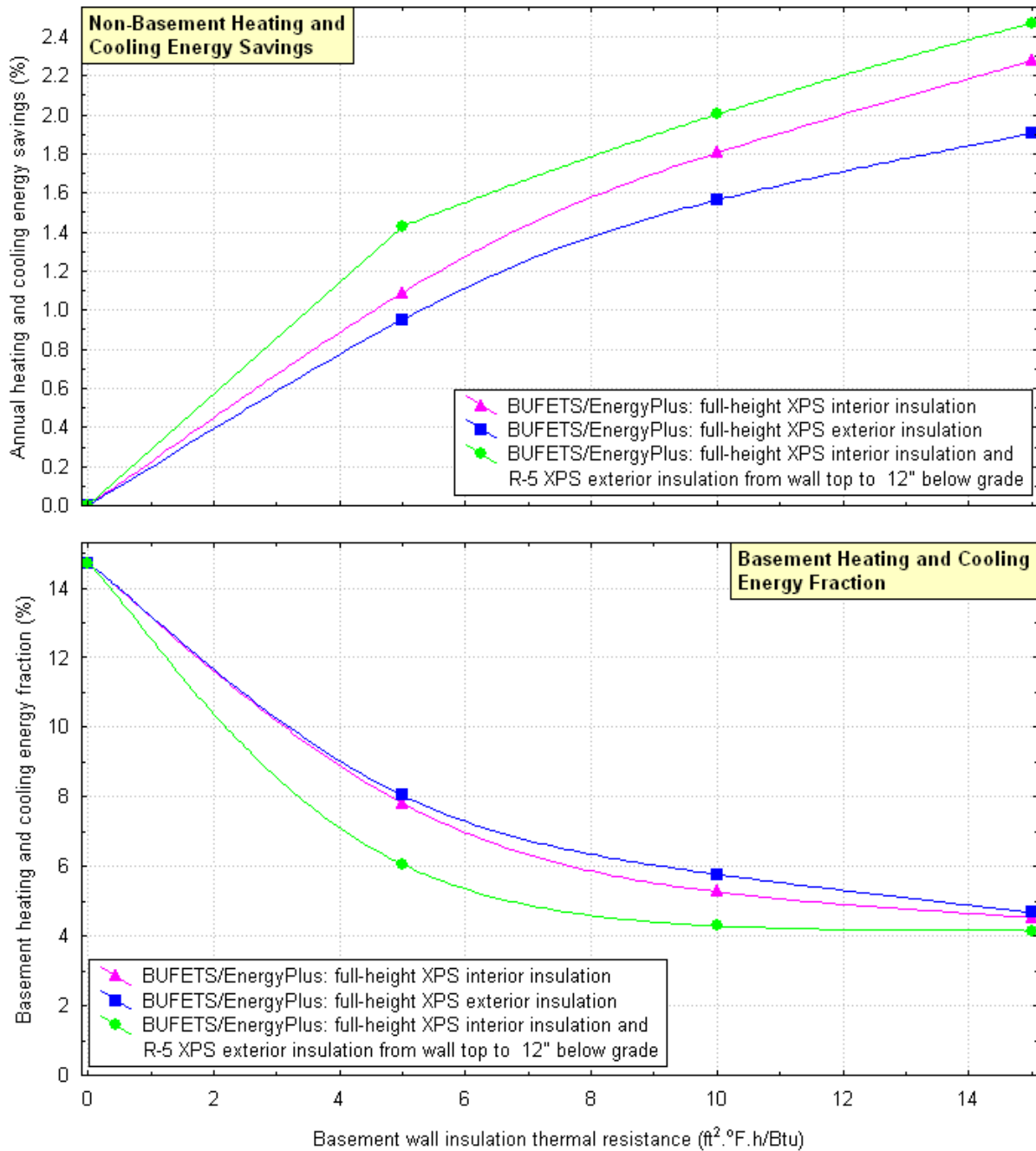

Figure 36. Building energy distribution for a basement with AGBG wall exposure for Minneapolis

INSULATION STRATEGY ENERGY COMPARISON FOR MINNEAPOLIS, MN

2-storey 2009 MN Energy Code Reference House with Full Basement:
Below-Grade Only Wall Exposure

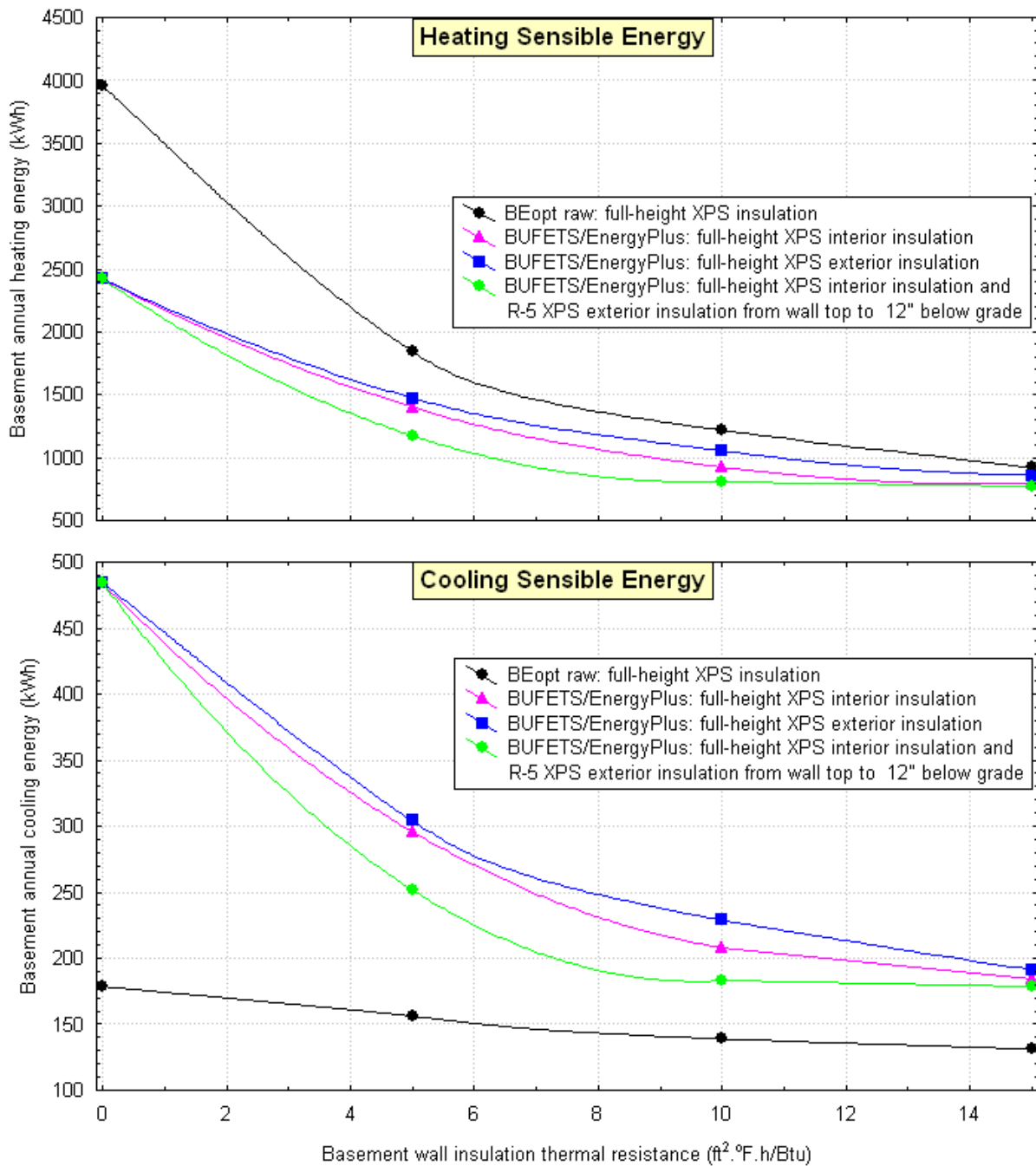

Figure 37. Basement heating and cooling energy for Minneapolis

Figure 33 depicts the site energy savings with the upper panel revealing that, again, the in the BG case, BEopt predicts site energy savings 4%–8.5% larger than BEM. The BEM BG savings are 1%–2% less than the AGBG savings. The source energy savings that are derived directly from

the site energy savings by applying multipliers to the latter follow the same pattern as the source energy savings in Figure 34.

Figure 35 shows the living space (technically more correctly reported in the figure as the “nonbasement”) savings in the BG case predicted by BEopt exceed those predicted by BEM by 2.5%–5%. However, in this case, the basement heating and cooling energy fractions simulated by the two models are similar, being almost the same at R_{US-15} . In the AGBG case of Figure 36, BEM nonbasement savings maximize at 2.5% at R_{US-15} , about 0.5% more than the BG case.

The final chart (Figure 37) compares the absolute basement energy consumption for the BG case only. The key metric (see Section 2.2) with regard to the relative magnitudes of the heating and cooling loads is the cooling/heating load ratio with no insulation. In the case of the BEM, this ratio is 20% (outside the acceptable 5% limit) and for BEopt, 4.5% (just within the limit). Further, the no-insulation BEopt/BEM absolute heating and cooling load ratios are 1.63 and 0.39, respectively. In other words with no foundation insulation, BEM significantly overpredicts the cooling load and underpredicts the heating load. As the insulation thermal resistance increases, the discrepancy decreases because with increasing insulation, the basement interior temperature increases and converges on the BUFETS interior temperature.

This phenomenology directly demonstrates the impact of mismatched BUFETS and EnergyPlus interior temperatures that, as required by the stability criterion, mandate that the EnergyPlus basement interior temperatures be lower than or equal to those of BUFETS. These lower temperatures result in underestimated heating loads and overestimated cooling loads. As shown in the comparison building, when interior basement temperature parity is achieved, BEM is accurate in absolute terms as well.

The iterative algorithm is computationally intractable with BUFETS, so the only immediate practical solution is to recast the BEopt model as a dual zone model in which the basement is separately conditioned and controlled to ensure that the basement interior temperatures exactly match those of BUFETS. The basement set point temperature schedule could be tuned to account for the lower basement temperatures encountered with a typical single-zone controlled house with a full basement, but this would be an approximation.

An alternative approximate solution involves artificially “one-dimensionalizing” the BUFETS heat fluxes using an analytic element methodology (Goldberg 2010) so that a thermal mass envelope element could be used in EnergyPlus to represent the foundation envelope; that is, the one-dimensional wall temperatures would be calculated at each time step in EnergyPlus. This is different from the current model in which a fixed R-value (nonmassive) element simply links the interior and scheduled soil temperatures to precisely replicate the heat fluxes (as in the original DOE 2.1C/Shen model). Great care would have to be taken to ensure that the one-dimensionalized calculated wall temperatures in BUFETS were reasonable. This model, theoretically, should eliminate the strict stability requirement and make the absolute heating and cooling values generated by BEM far closer in magnitude to those achieved with the exact basement interior temperature match achieved in the comparison model. However, whether the heat flux accuracy of this model would be equivalent to that of the existing model under temperature parity conditions would be a matter for further inquiry.

This result gives a key finding of this project; namely, that in terms of absolute accuracy, there really is no computationally tractable alternative to a fully integrated three-dimensional earth contact model in EnergyPlus, or conversely, fully integrating EnergyPlus into BUFETS or equivalent. In this latter case, EnergyPlus would effectively become an “interior boundary condition” generator for BUFETS (or equivalent), which, given the fast single time step execution speed of EnergyPlus, would theoretically be a computationally tractable solution.

The larger issue is that there is no easy solution to the integrated three-dimensional earth contact/whole-building energy simulation problem for making accurate absolute predictions. A split model is adequate in relative terms if absolute accuracy is not required and there is scope for improving the split model; otherwise, the only variable is the degree of computational tractability that can be achieved by the various simulation strategies discussed.

5.5 Full Basement Application for Bemidji

The full basement Bemidji results closely follow those of Minneapolis in relative terms, as expected. Thus Figures 38 through 42 are very similar to their Minneapolis counterparts of Figures 32 through 36. Generally, the BEM energy savings achieved are higher for Bemidji, for example, a BG IntExt basement energy savings of 74.1% for Bemidji compared with 67.4% for Minneapolis.

INSULATION STRATEGY PERFORMANCE COMPARISON FOR BEMIDJI, MN

2-storey 2008 MN Energy Code Reference House with Full Basement

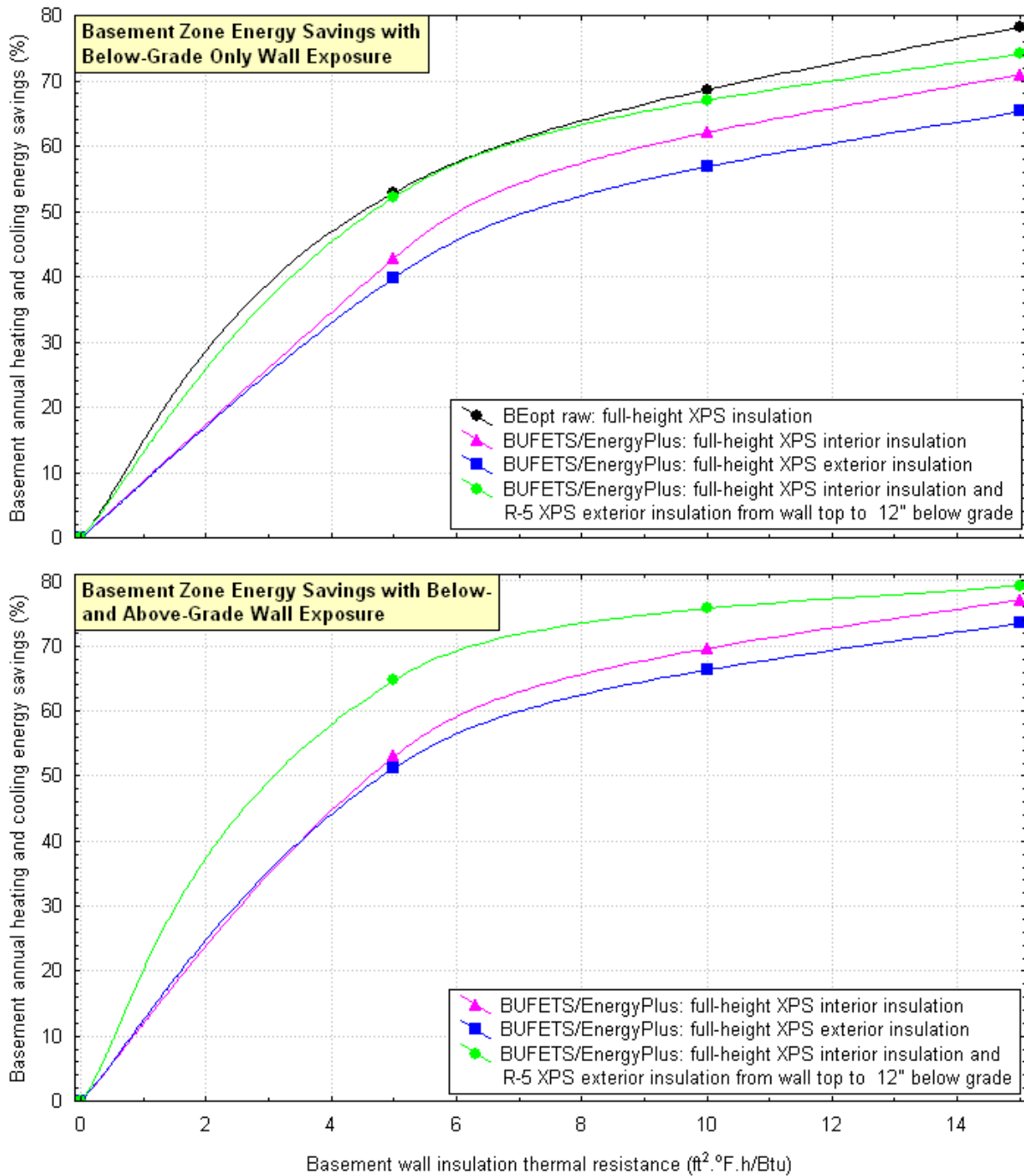

Figure 38. Basement heating and cooling energy savings for Bemidji

INSULATION STRATEGY SITE ENERGY PERFORMANCE COMPARISON FOR BEMIDJI, MN

2-storey 2009 MN Energy Code Reference House with Full Basement

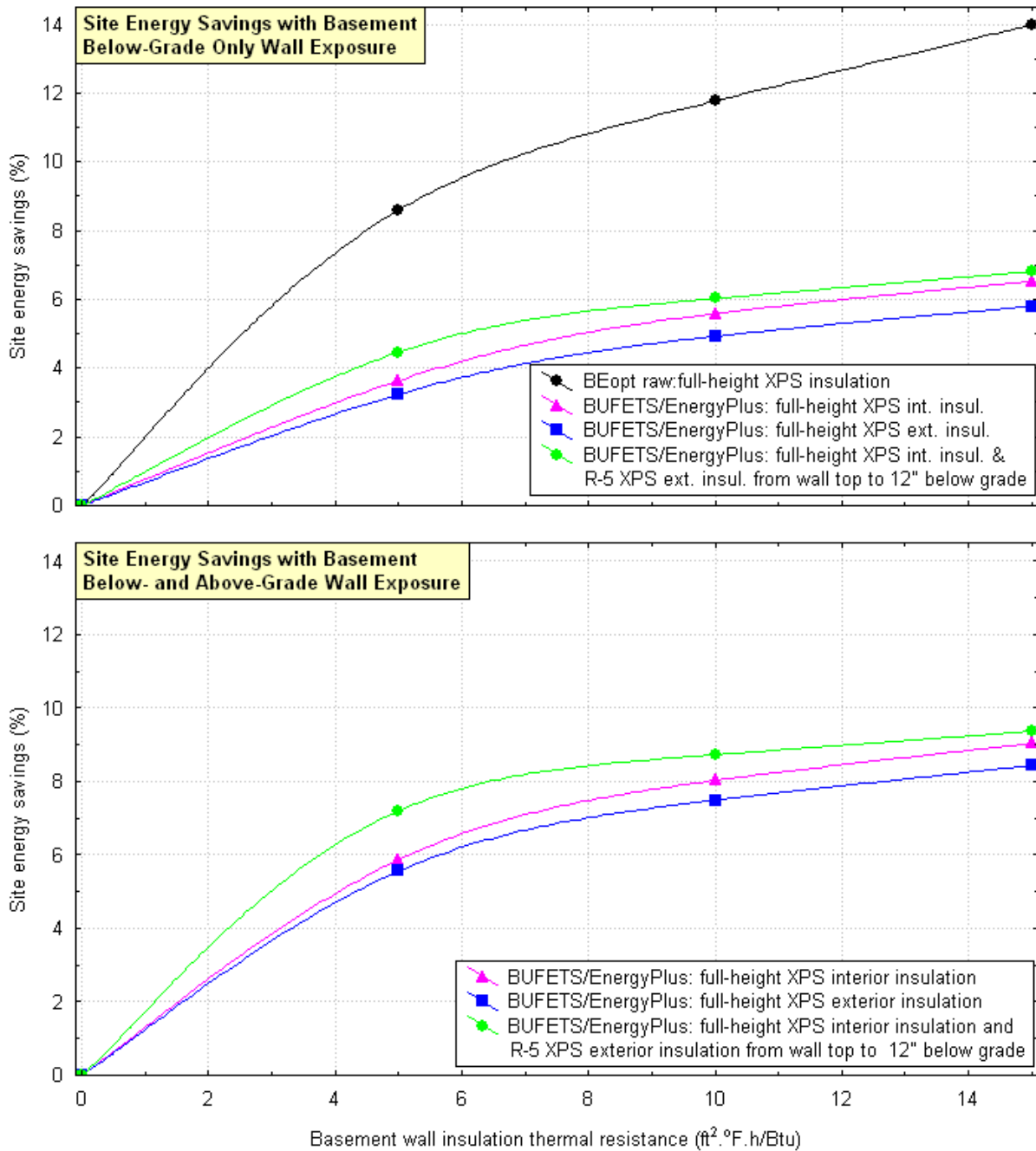

Figure 39. Site energy savings produced by basement foundation wall insulation for Bemidji

INSULATION STRATEGY SOURCE ENERGY PERFORMANCE COMPARISON FOR BEMIDJI, MN

2-storey 2009 MN Energy Code Reference House with Full Basement

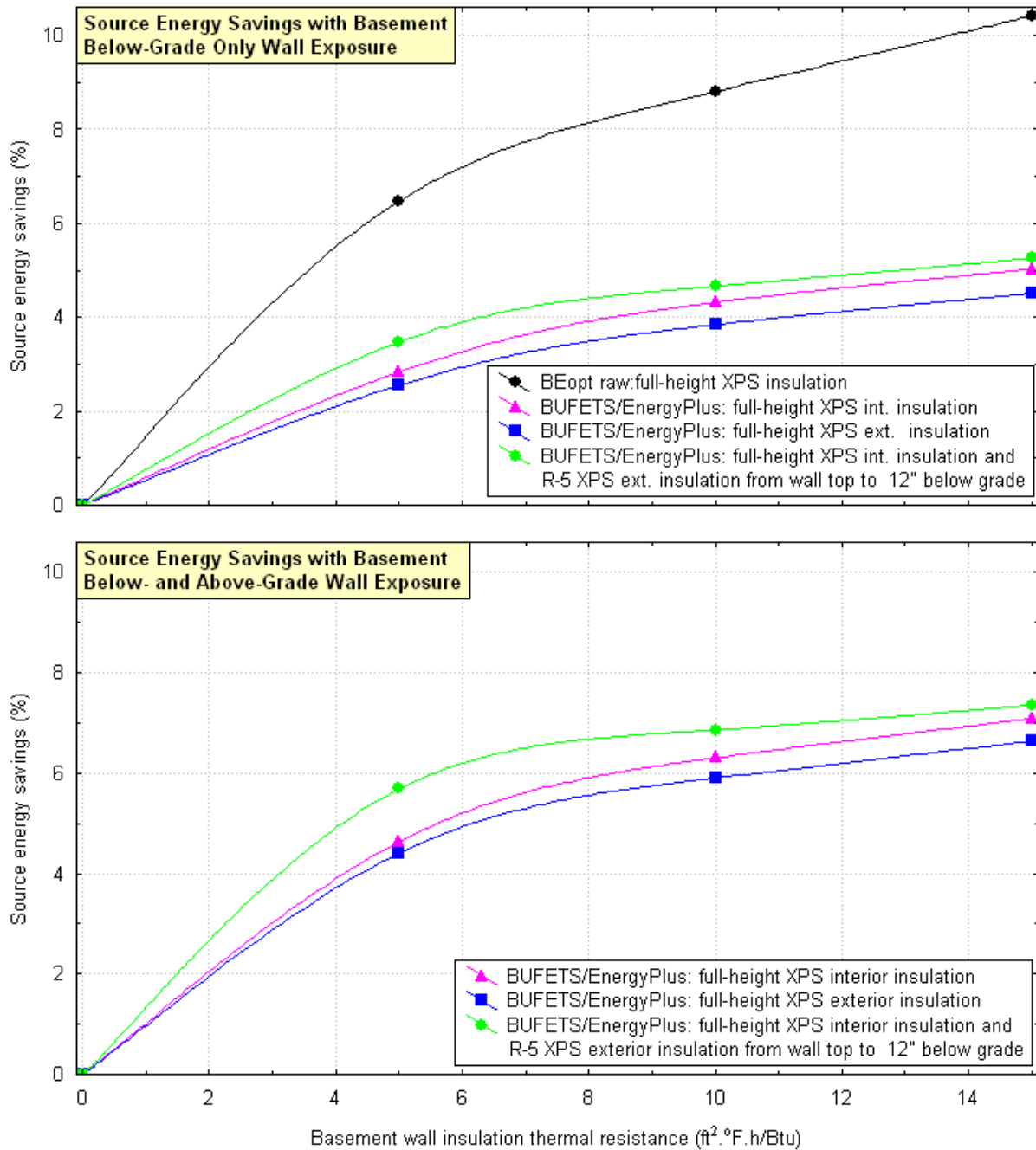

Figure 40. Source energy savings produced by basement foundation wall insulation for Bemidji

**BUILDING ENERGY DISTRIBUTION FOR BEMIDJI, MN:
BASEMENT WITH BELOW-GRADE ONLY WALL EXPOSURE**

2-storey 2009 MN Energy Code Reference House with Full Basement

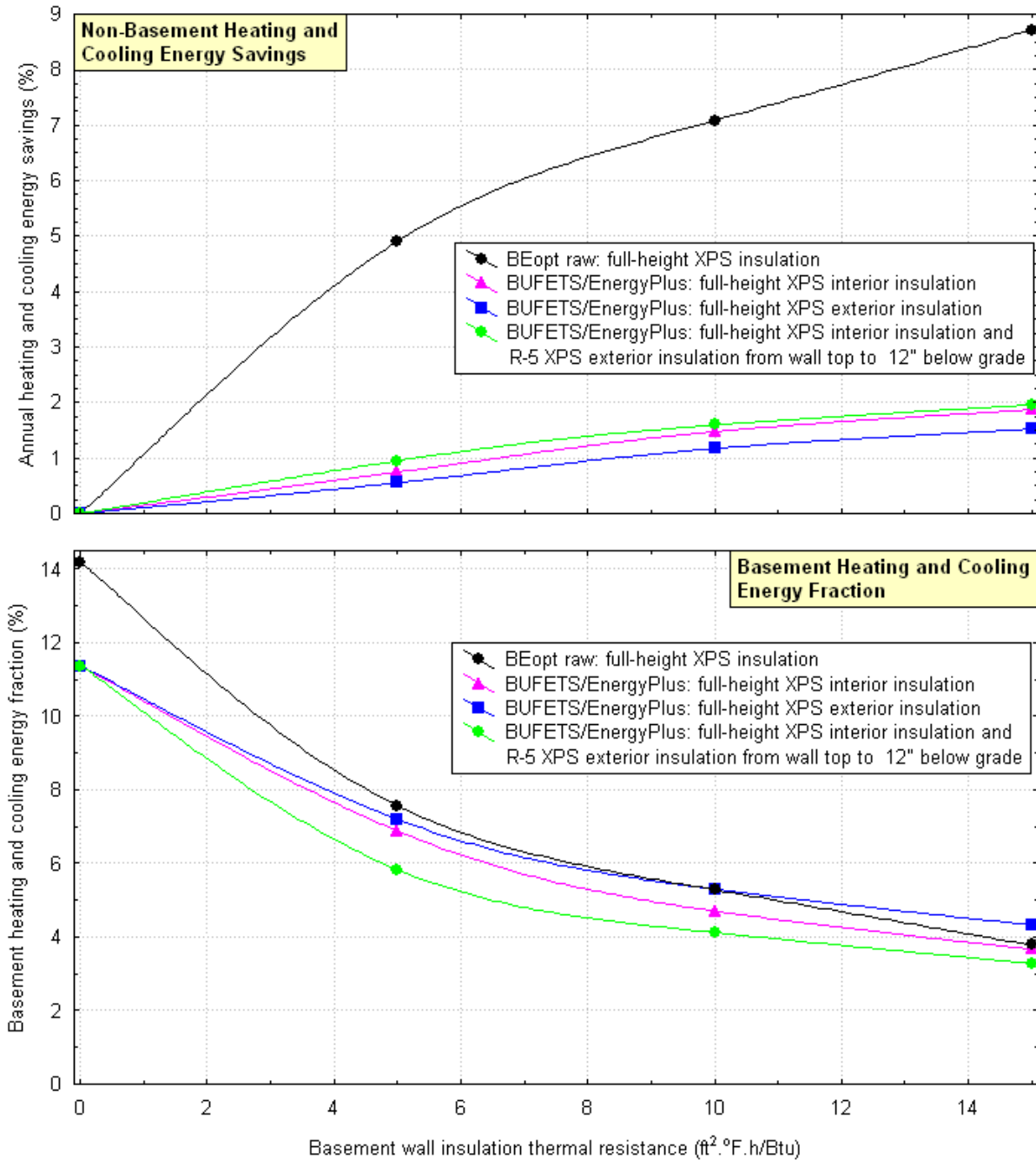

Figure 41. Building energy distribution for a basement with BG only wall exposure for Bemidji

**BUILDING ENERGY DISTRIBUTION FOR BEMIDJI, MN:
BASEMENT WITH BELOW-GRADE ONLY WALL EXPOSURE**

2-storey 2009 MN Energy Code Reference House with Full Basement

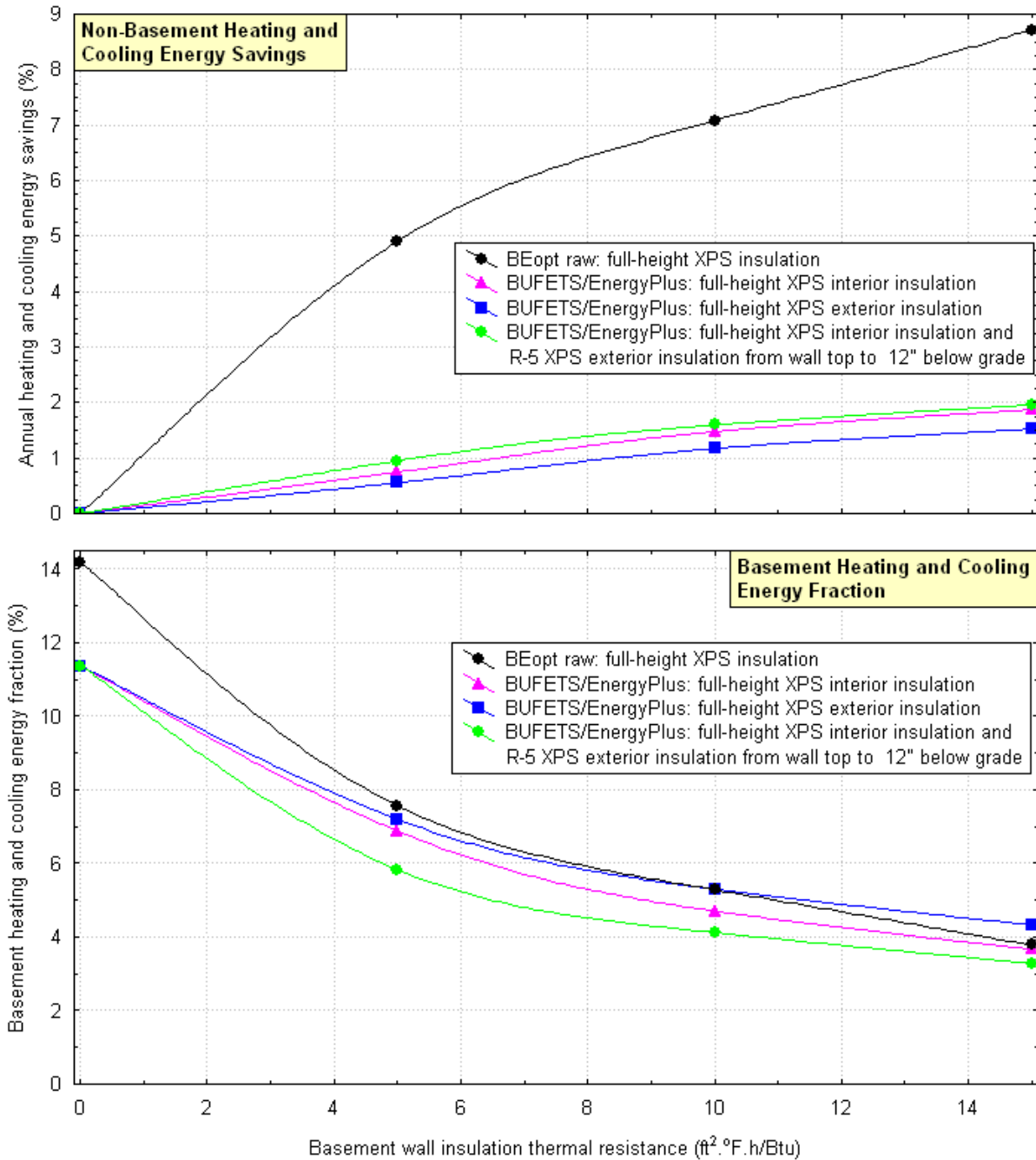

Figure 42. Building energy distribution for a basement with AGBG wall exposure for Bemidji

In absolute terms, from Figure 43, the BEM zero-insulation basement cooling/heating energy ratio is 11%; that for BEopt is 1.3%, less than the corresponding ratios for Minneapolis. The no-insulation BEopt/BEM absolute heating and cooling load ratios are 1.50 and 0.17, respectively.

Thus the discrepancy is improved from heating perspective compared with Minneapolis, but worse from a cooling perspective. This arises because the BEOpt cooling loads appear to be independent of insulation thermal resistance for Bemidji, whereas for the comparison building, the cooling loads increase or decrease with thermal resistance (see Figure 10). This is an instance where the absolute deficiencies in the standard EnergyPlus foundation model are apparent.

INSULATION STRATEGY ENERGY COMPARISON FOR BEMIDJI, MN

2-storey 2009 MN Energy Code Reference House with Full Basement:
Below-Grade Only Wall Exposure

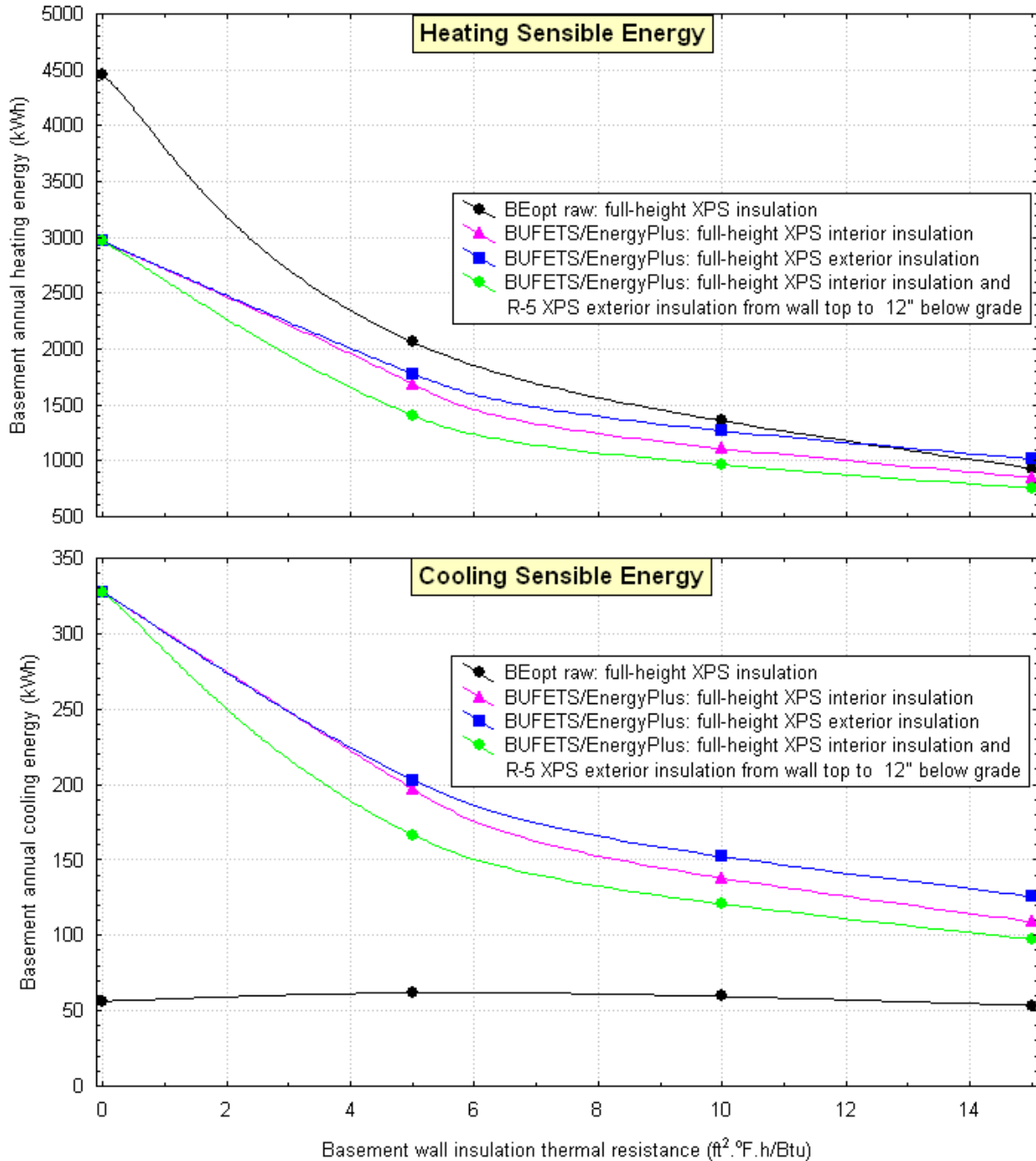

Figure 43. Basement heating and cooling energy for Bemidji

The BUFETS/EnergyPlus heating temperature mismatch is less than that for Minneapolis, but the cooling temperature discrepancy is greater than that for Minneapolis, as might be expected for a colder climate.

5.6 Crawlspace Application for Bemidji

The crawlspace simulation results for Bemidji are shown in Figures 44 through 47. In the case of the crawlspace, as only an interior insulation placement is simulated and the crawlspace is unconditioned, only the living space energy results are presented. Now, in any case, the crawlspace is unconditioned, so it essentially functions as dead air space that increases the thermal resistance between the living space floor and the earth surrounding the crawlspace. In this configuration, the BEM is technically invalid; however, the results were calculated anyway to illustrate the effects of exacerbating the BEM temperature mismatch.

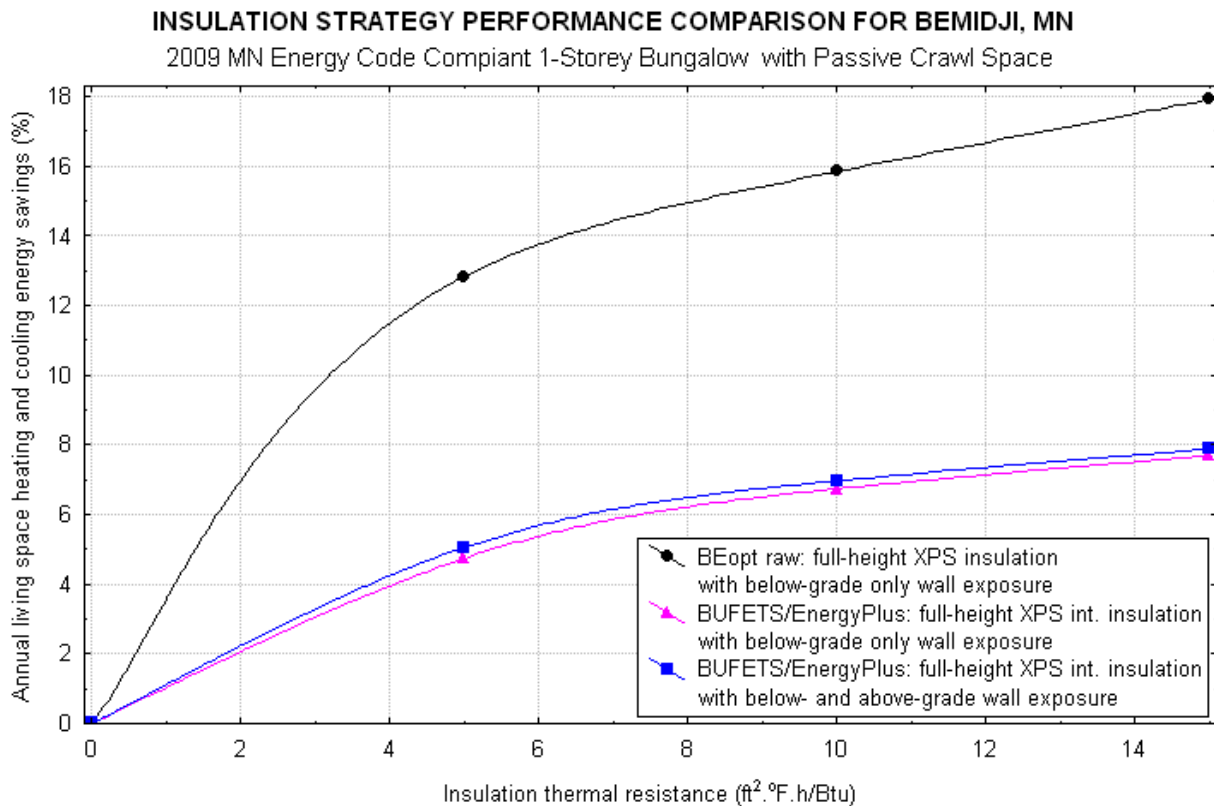

Figure 44. Living space heating and cooling energy savings from crawlspace wall insulation for Bemidji

INSULATION STRATEGY SITE ENERGY PERFORMANCE COMPARISON FOR BEMIDJI, MN
 2009 MN Energy Code Compliant 1-Storey Bungalow with Passive Crawl Space

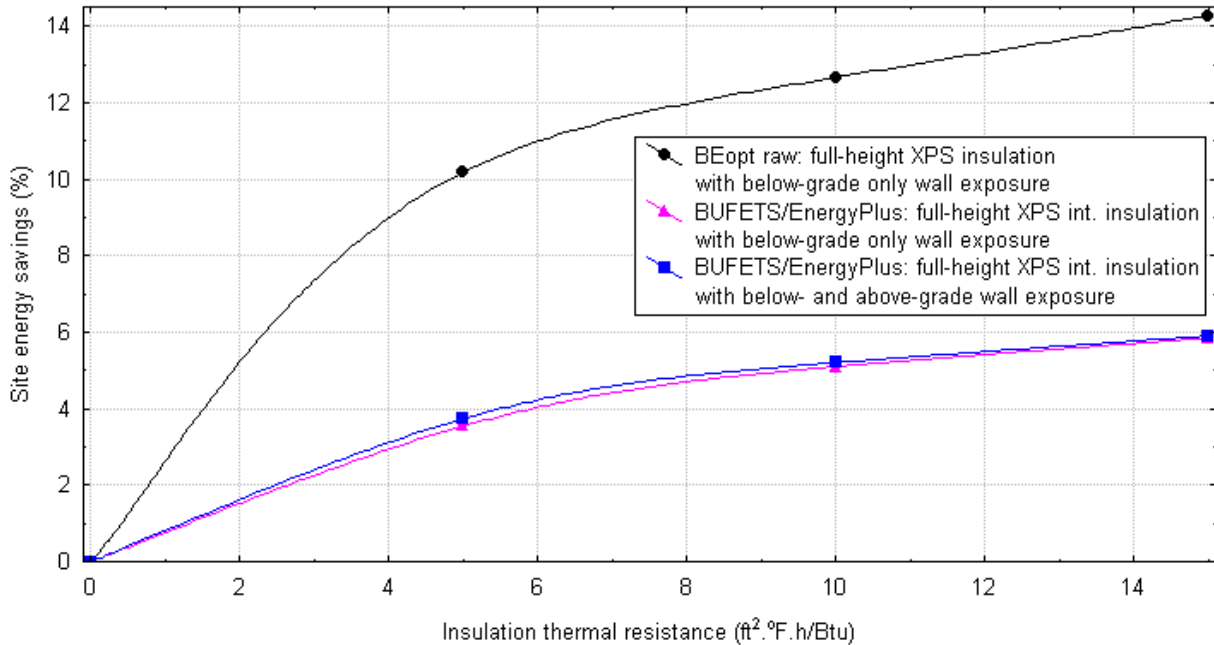

Figure 45. Site energy savings from crawlspace wall insulation for Bemidji

INSULATION STRATEGY SOURCE ENERGY PERFORMANCE COMPARISON FOR BEMIDJI, MN
 2009 MN Energy Code Compliant 1-Storey Bungalow with Passive Crawl Space

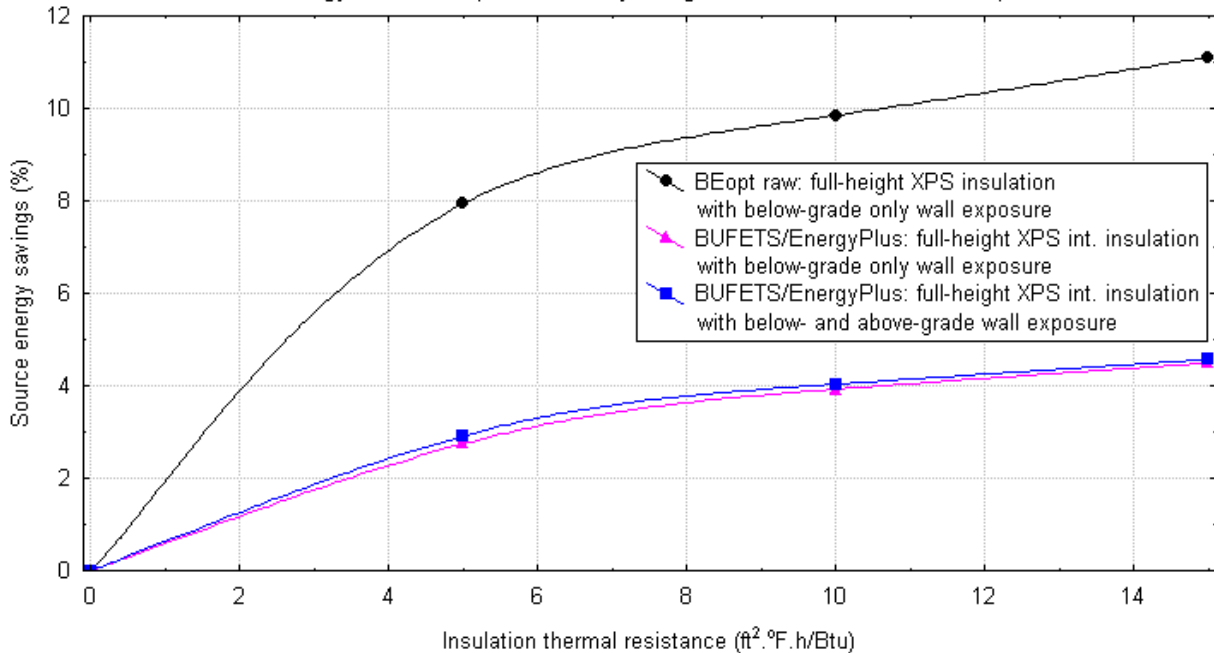

Figure 46. Source energy savings from crawlspace wall insulation for Bemidji

INSULATION STRATEGY ENERGY COMPARISON FOR BEMIDJI, MN
 2009 MN Energy Code Compliant 1-Storey Bungalow with Passive Crawl Space

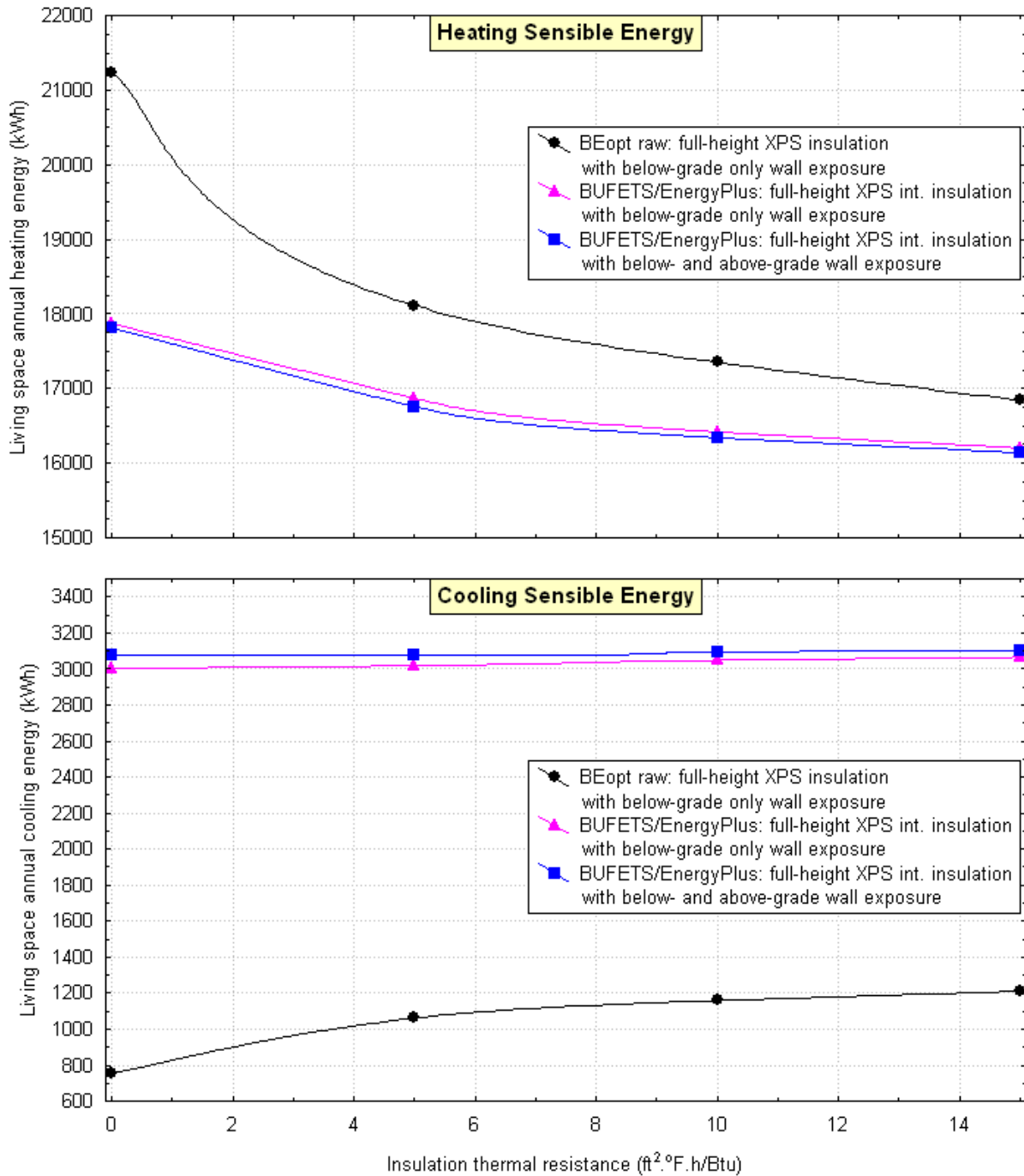

Figure 47. Living space heating and cooling energy dependence on crawlspace wall insulation for Bemidji

Figure 44 through 46 show the living space, site, and source energy savings as a function of crawlspace wall insulation thermal resistance. Once again, BEopt overestimates the savings

chiefly because the crawlspace floor is assumed to be adiabatic so the wall savings are 100% of the earth contact envelope savings. In source energy terms, this overestimate is about 8% at R_{US-15} . In Figure 44, the AGBG savings are just 2% larger than those of the BG savings as a result of the 6-in. exposed AG wall height emphasizing the nonlinearity of the energy impact of the exposed wall height.

In the case of an unconditioned crawlspace, the no-insulation BG BEM and BEopt cooling/heating ratios are not relevant. The BG BEopt/BEM heating and cooling ratios are 1.19 and 0.25, respectively, better for heating and worse for cooling than their counterparts for a full basement in Figure 43. The upper panel of Figure 47 indicates that the BEopt and BEM heating loads converge as the crawlspace temperature increase with wall insulation. However, the lower panel of Figure 47 demonstrates that the crawlspace temperature is actually substantially higher than the BUFETS temperature as shown by the much larger flat cooling load indicating that the BEM model was unstable in this case (the same phenomenology as encountered for the Janesville basement in Figure 24).

5.7 Crawlspace Application for Minneapolis

The pattern of results for the crawlspace building modeled in Minneapolis is similar to the pattern for Bemidji. Figure 48 shows a living space maximum energy savings overestimate of 5%, less than the 10% over-estimate for Bemidji (Figure 44). This overestimate translates to about 4% in site and source energy terms (Figures 45 and 46). Otherwise, Figures 48, 49 and 50 show the same phenomenology as Figures 44, 45 and 46 for Bemidji, thus the previous discussion applies to these figures as well.

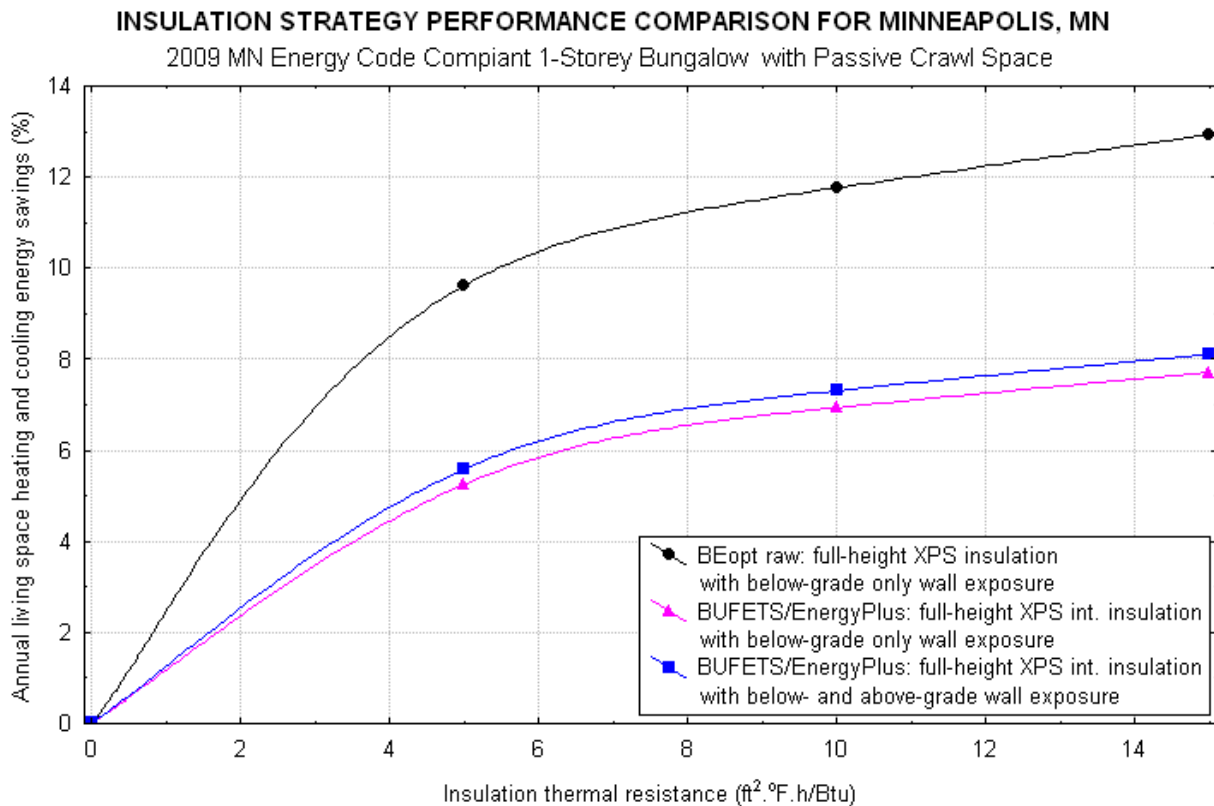

Figure 48. Living space heating and cooling energy savings from crawlspace wall insulation for Minneapolis

INSULATION STRATEGY SITE ENERGY PERFORMANCE COMPARISON FOR MINNEAPOLIS, MN
 2009 MN Energy Code Compliant 1-Storey Bungalow with Passive Crawl Space

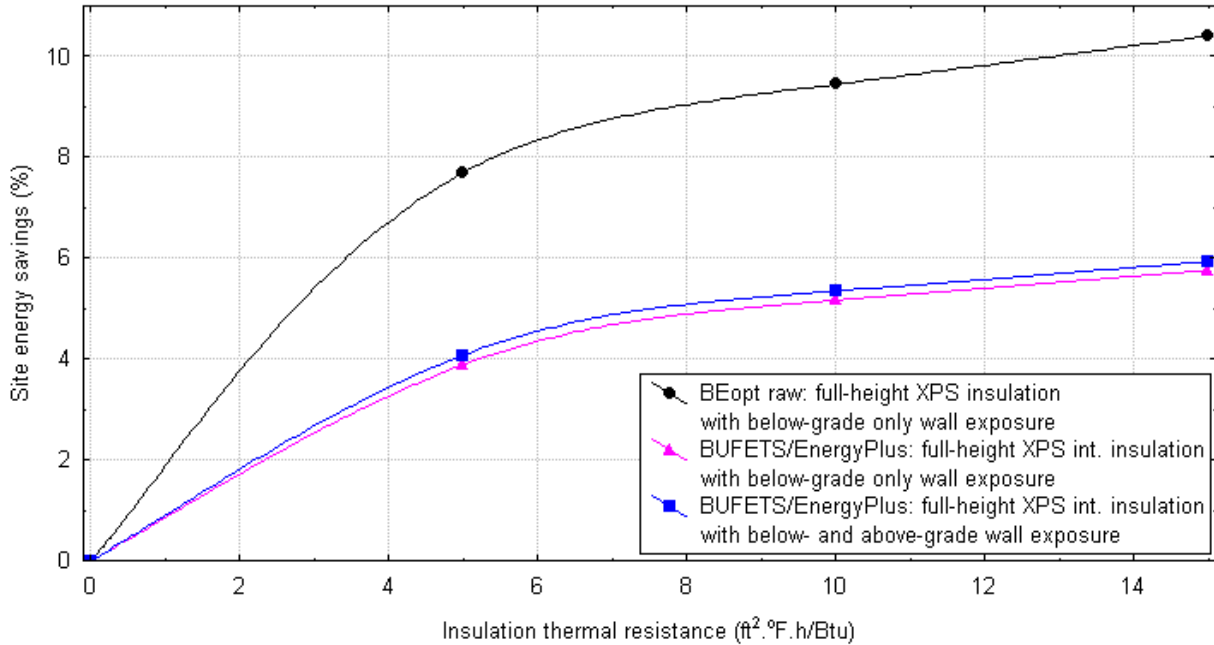

Figure 49. Site energy savings from crawlspace wall insulation for Minneapolis

INSULATION STRATEGY SOURCE ENERGY PERFORMANCE COMPARISON FOR MINNEAPOLIS, MN

2009 MN Energy Code Compliant 1-Storey Bungalow with Passive Crawl Space

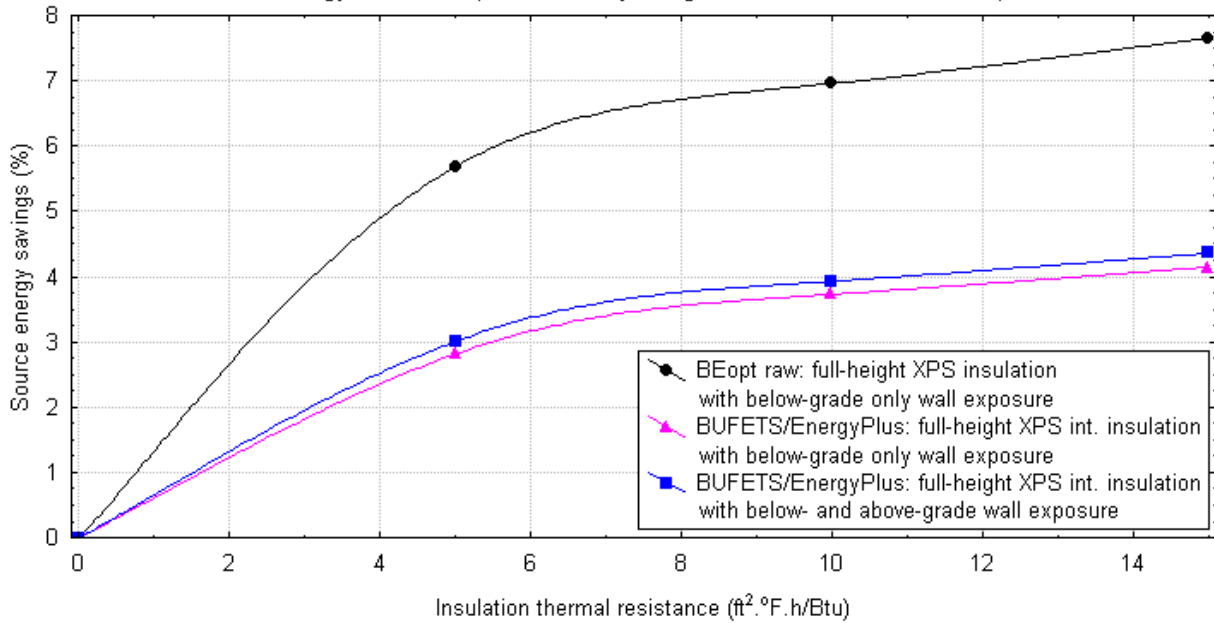

Figure 50. Source energy savings from crawlspace wall insulation for Minneapolis

From Figure 51, the BEOpt/BEM BG no-insulation heating and cooling ratios were 1.35 and 0.35 respectively, worse for heating and better for cooling than Bemidji. Once again, the cooling loads in the lower panel of Figure 51 show the same instability resulting from a crawlspace temperature higher than the living space temperature used in BUFETS as the crawlspace conditioning temperature.

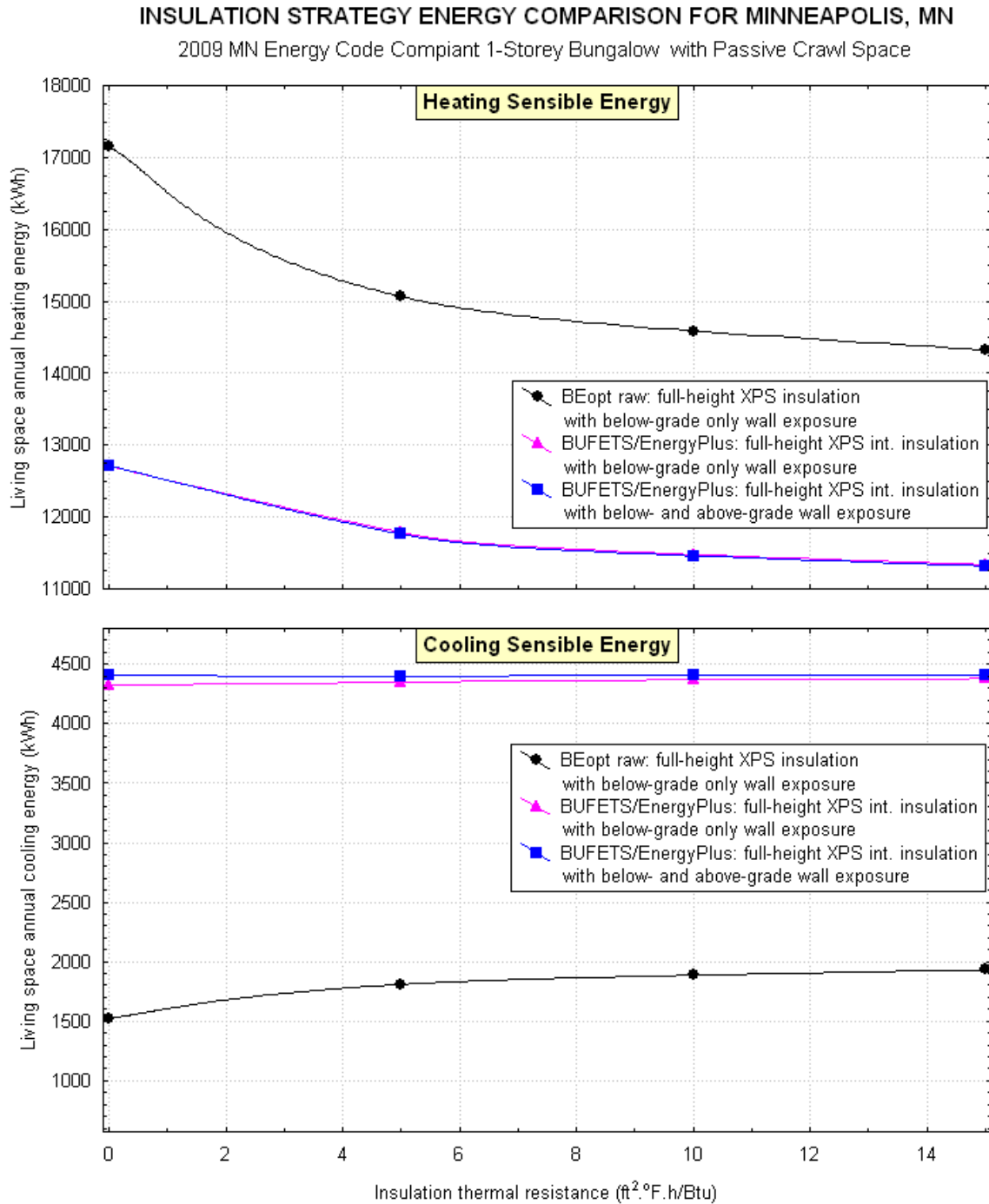

Figure 51. Living space heating and cooling energy dependence on crawlspace wall insulation for Minneapolis

5.8 Crawlspace Application for Janesville

The patterns discussed for the crawlspace buildings modeled in Bemidji and Minneapolis are consistent for Janesville as well. That is, the phenomenology of Figures 52 through 54 is the same as that of the corresponding figures for Bemidji (Figures 44 through 46) and Minneapolis (Figures 48 through 50). However, in this case, from Figure 55, the BG no-insulation BEM heating and cooling ratios are 1.21 and 0.23 respectively, in both cases within 0.02 of the Bemidji values. The consistent pattern of thermal instability shown in the previous two climates is shown in Janesville and maintained for the cooling loads in Figure 55.

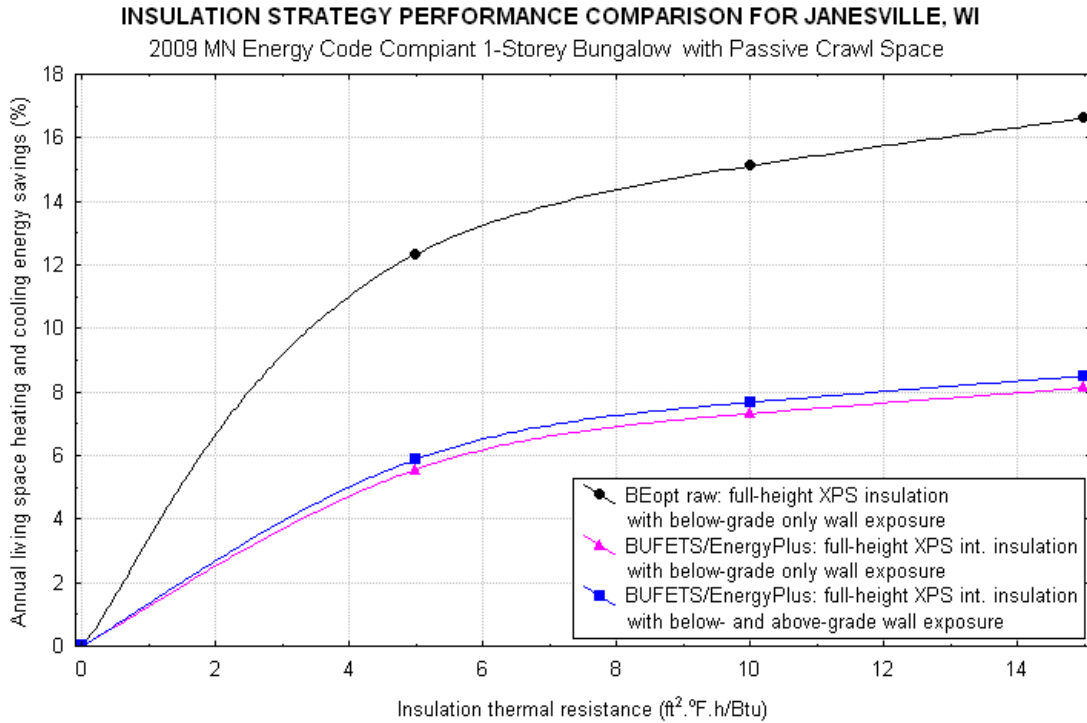

Figure 52. Living space heating and cooling energy savings from crawlspace wall insulation for Janesville

INSULATION STRATEGY SITE ENERGY PERFORMANCE COMPARISON FOR JANESVILLE, WI
 2009 MN Energy Code Compliant 1-Storey Bungalow with Passive Crawl Space

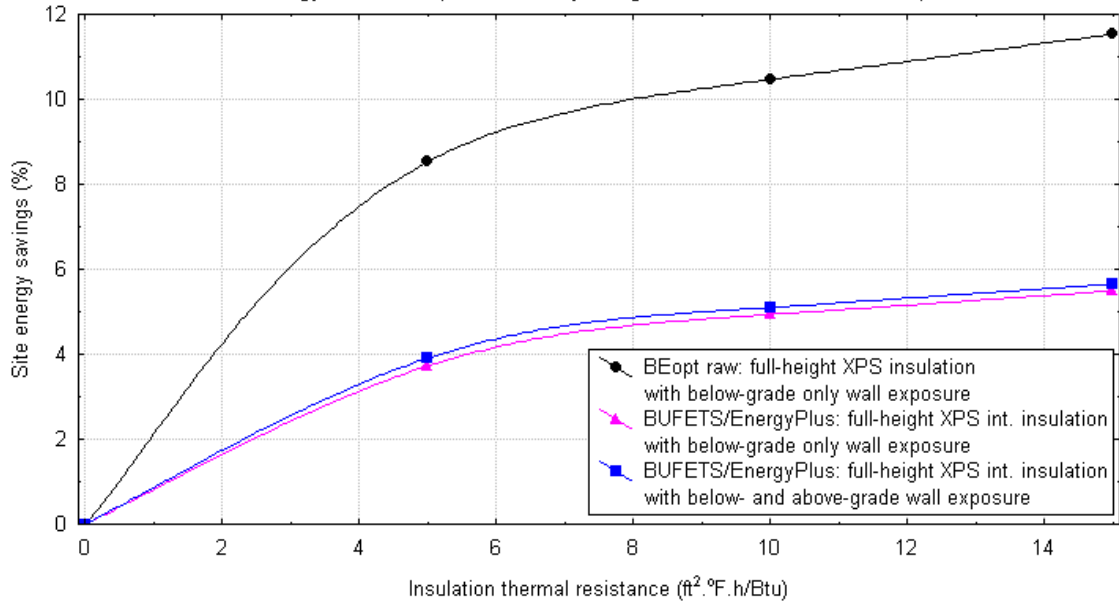

Figure 53. Site energy savings from crawlspace wall insulation for Janesville

INSULATION STRATEGY SOURCE ENERGY PERFORMANCE COMPARISON FOR JANESVILLE, MN
 2009 MN Energy Code Compliant 1-Storey Bungalow with Passive Crawl Space

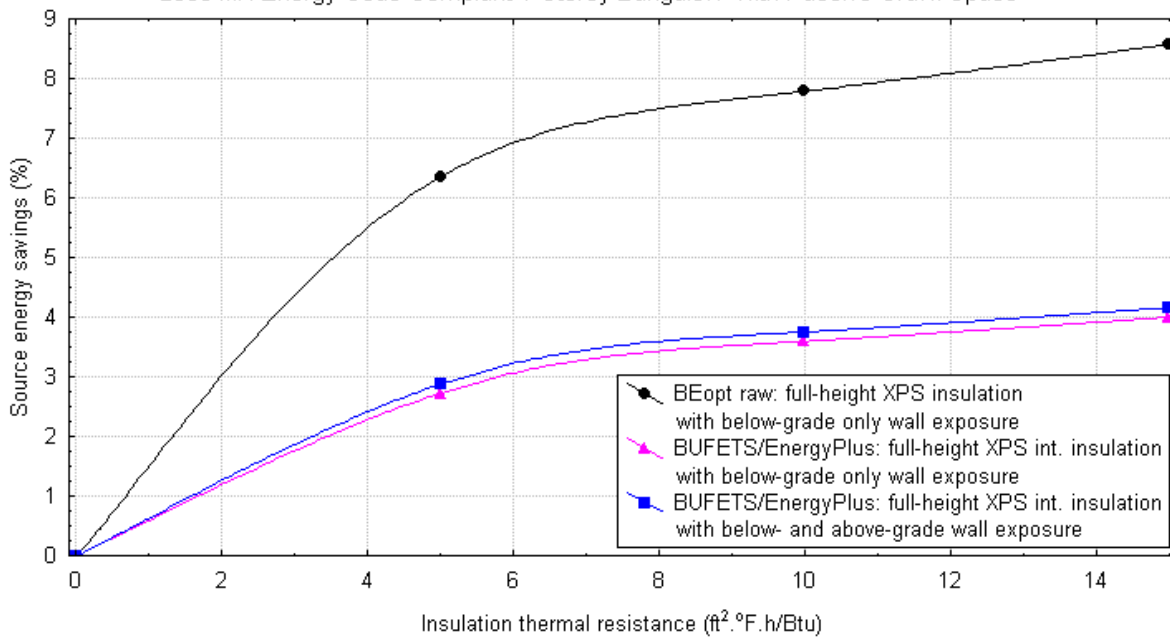

Figure 54. Source energy savings from crawlspace wall insulation for Janesville

INSULATION STRATEGY ENERGY COMPARISON FOR JANESVILLE, MN
 2009 MN Energy Code Compliant 1-Storey Bungalow with Passive Crawl Space

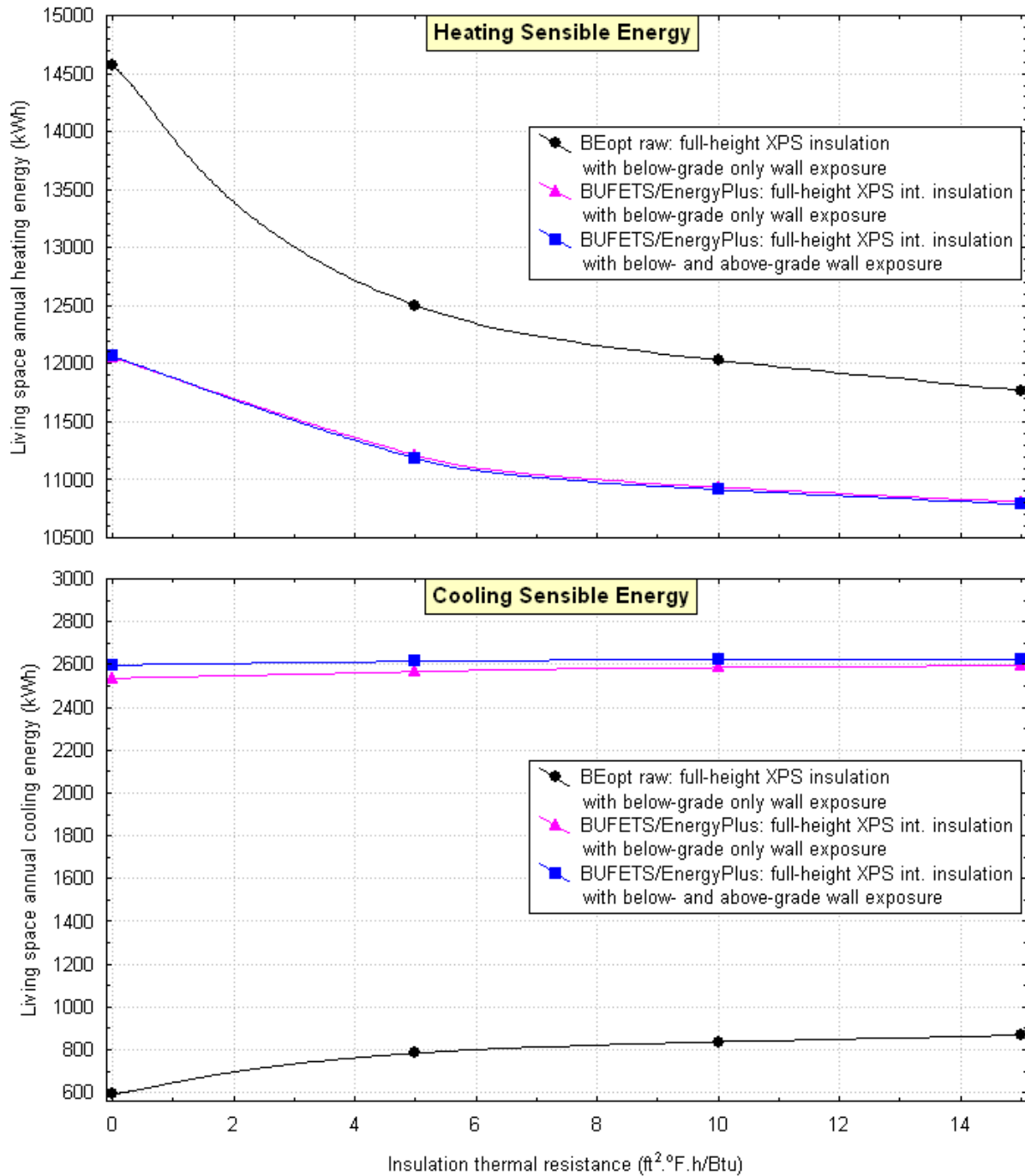

Figure 55. Living space heating and cooling energy dependence on crawl space wall insulation for Janesville

6 Conclusions

The key conclusion that can be drawn from the simulation results is that the BEM is strictly valid only when it is applied to a building model in which the ambient and interior foundation system temporal temperature profiles are identical in the BUFETS and EnergyPlus simulations. This is consistent with previous research. As the divergence between the BUFETS and EnergyPlus foundation system interior temperature profile increases, the level of absolute accuracy falls. As long as the BUFETS temperatures are higher than the EnergyPlus temperatures, the BEM is stable and yields physically reasonable relative (or energy savings) results. With the reverse condition (EnergyPlus temperatures greater than BUFETS temperatures), the BEM becomes unstable and generates physically incorrect results.

Comparing experimental whole-house site energy savings data for retrofit foundation insulation in a cold (Minnesota) climate with the simulations shows that the BEM simulated site energy savings are in the middle of the experimentally measured range for the Minneapolis climate simulated and the BEopt energy savings are either at or exceed the high end of the range. In the experimental site (as opposed to source) energy context, BEopt likely overpredicts and BUFETS/EnergyPlus likely underpredicts the savings for BG only foundation walls (AG foundation walls cannot be modeled in BEopt). In absolute percentage terms, the BEopt site energy savings exceed those of BEM by a maximum of 10.5% (R_{US-15} interior insulation in Madison) to a minimum of 4.7% (R_{US-5} interior insulation in Bemidji). In absolute whole-house site energy savings terms, for a foundation wall with AG and BG components, the margin between interior and exterior placement has a minimum of 0.21% (R_{US-15} in Madison) and a maximum of 0.6% in Bemidji. The differences are less than 1%, so ignoring insulation placement in BEopt is justified.

The BEopt results are qualitatively correct in suggesting whole-house energy savings accruing from foundation insulation are less than 15% and the BEM results show whole-house site energy savings for a BG only foundation wall range from a high of 6.8% (R_{US-15} interior + R_{US-5} AG exterior insulation in Bemidji) to a low of 1.5% (R_{US-5} exterior insulation in Madison). With both AG and BG foundation wall components, BEM shows an energy savings range of 6% (R_{US-5} exterior insulation in Madison) to 8.7% (R_{US-15} interior + R_{US-5} AG exterior insulation in Bemidji). Including the AG wall component does improve energy savings (2% and 4.5% increases at the maximum and minimum ends of the savings range, respectively). Thus it appears that the absence of AG foundation walls in the BEopt model does have an increasingly significant impact on the whole-house energy savings predictions as the severity of the heating climate decreases.

Given the likely overprediction of the savings by BEopt and the underprediction of the savings by BEM (Section 5.3), these results effectively bound the expected savings. Therefore, realistic savings that can be expected for an insulation retrofit on a foundation wall with BG exposure only would be an average of the bounding values giving a range for interior insulation placement of 5.5% (R_{US-5} , Madison) to 10.3% (R_{US-15} , Bemidji).

As currently constituted, BEopt generates full basement and crawlspace foundation models that yield floating interior temperatures. These foundation models are not suitable for use in the

BEM. Nevertheless, a comparison of the results generated by BEopt and BEM shows that both models show qualitatively correct behavior compared with experimental data. BEopt tends to overpredict and BEM tends to underpredict the whole-house site energy savings produced by foundation wall insulation. As the source energy savings are derived simply from the site energy savings by multiplication with correction factors, this conclusion also applies to the source energy savings.

To apply the BEM (or any equivalent split simulation model) in a computationally tractable way, the BEopt foundation models need to be configured so a precise foundation interior set point temperature schedule can be maintained. This requires that the foundation system be conditioned with a separate HVAC plant controlled by an independent thermostat. Clearly this introduces an error into the analysis, because most real foundation systems do not have independently controlled HVAC plants. The error would tend to overestimate the absolute building energy consumption to achieve the benefit of accurate foundation energy envelope heat flows. This, in turn, allows the absolute energy savings realized from different foundation insulation placements and levels of thermal resistance to be calculated.

The chief limitation for correcting this situation by iterating between the BUFETS and EnergyPlus simulations until foundation system interior temperature convergence is achieved (as is required theoretically), is the high computational load imposed by BUFETS (or any similar three-dimensional earth contact energy simulation code) relative to EnergyPlus. A single year of BUFETS simulation currently takes about 200 times longer than that needed for EnergyPlus.

The optimum solution is to integrate BUFETS (or equivalent) and EnergyPlus into a single unified simulation. This can be achieved either by effectively running BUFETS as a subroutine within EnergyPlus, or vice versa, running EnergyPlus as a subroutine of BUFETS. In computational terms, the latter approach is likely more tractable.

In the interim, to achieve an accurate relative accounting of the energy performance (that is, the energy savings of different placements of foundation insulation as a function of thermal resistance) of actual foundations in the zone 6 and 7 retrofit housing stock, it is necessary to proceed by using an ideal BEopt foundation model including a separately controlled foundation system HVAC plant. Alternative solutions such as deploying an analytic element coupling methodology between BUFETS and EnergyPlus would, in theory, allow floating basement temperatures (without causing instability) by allowing EnergyPlus to calculate the basement wall and slab temperatures using its native conduction transfer function methodology. As this would improve the accuracy of the radiation energy calculation at the wall interior surface over the current methodology, this approach likely also would resolve the simulated cooling load issues revealed by the BEM as well.

Overall, the results provide a clear demarcation of the issues surrounding the physically accurate modeling of foundation system energy savings within the context of the Building America program. There are no easy or simple solutions and the alternatives to the, as yet, unrealized fully integrated earth contact/whole-building simulation can only offer varying degrees of approximation. Nevertheless, despite its limitations and the tedium and complexity of its implementation, the BEM does solve the immediate problem of predicting the energy

performance of real foundation configurations in cold climates for the predominant sensible heating loads within the bounds of published experimental data.

On balance, though, use of the BEM cannot be recommended as an ideal solution to foundation energy simulation in the context of BEopt, because implementing it is complex. However, it does provide the necessary capacity for the Northern*STAR* team to proceed with its foundation insulation retrofit program.

References

- ASHRAE/ANSI. (2009). Criteria for Moisture-Control Design Analysis in Buildings, ANSI/ASHRAE Standard 160.
- Goldberg, L.F.; Huelman P.H. (2005). Minnesota Energy Code Building Foundation Rule: Amendment Proposal Development Project Final Report, Project Research Report, www.buildingfoundation.umn.edu/FinalReportWWW/default.htm, ESDP, University of Minnesota.
- Goldberg, L.F.; Huelman, P.H.; Gatland, S.D. II. (2010). A Prototype Universal Building Envelope Hygrothermal Performance Standard for Successful Net-Zero Energy Building Design. In *Proceedings Buildings XI, ASHRAE*, Clearwater Beach.
- Goldberg, L.F. (2010). Quantification of Changes in Residential/Multifamily Building Codes and Standards for Assessing Energy Conservation and Efficiency Impacts in a Cold Climate: The Minnesota Residential Energy Quantification Tool. www.buildingphysics.umn.edu/MQT/MQT.htm. Energy Systems Design Program, University of Minnesota.
- Goldberg, L.F. (2011). The Foundation Test Facility, www.buildingfoundation.umn.edu/ff.htm. Energy Systems Design Program, University of Minnesota.
- Huang, Y.J.; Shen, L.S.; Bull, J.C.; Goldberg, L.F. (1988). Whole House Simulation of Foundation Heat Flows Using the DOE 2.1C Program. *ASHRAE Transactions* 94(2)936–946.
- Labs, K.; Shen, L.; Carmody, J.; Huang, Y.J.; Sterling, R.L.; Parker, D. (1988). Building Foundation Design Handbook, University of Minnesota.
- Maref, W.; Swinton, M.C.; Kumaran, M.K.; Bomberg, M.T. (2000). Three-Dimensional Analysis of Thermal Resistance of Exterior Basement Insulation System (EIBS). *Building & Environment* 36(4)407–419.
- Minnesota Statutes. (2009). Chapter 1322, Department of Labor and Industry, Residential Energy Code, Section N1102.2.6 Basement walls.
- Robinson, D.A.; Shen, L.S.; Nelson, G.D.; Hewett, M.J.; Noble, M.T.; Goldberg, L.F. (1990). Cold Climate Foundation Insulation Retrofit Performance. *ASHRAE Transactions* 96(2)573–579.
- Sheltersource. (2002). Evaluating Minnesota Homes Final Report, prepared for the Minnesota Department of Commerce.
- Shen, L.S. (1986). An Investigation of Transient, Two-Dimensional Coupled Heat and Moisture Flow in Soils, Ph.D thesis, University of Minnesota.
- Shen, L.S.; Poliakova J.; Huang, Y.J. (1988). Calculation of Building Foundation Heat Loss Using Superposition and Numerical Scaling. *ASHRAE Transactions* 94(2)917–935.

Appendix A: Tabulated Energy Simulation Results

Table 8. Two-Story 2009 Minnesota Energy Code Reference House With Full Basement for Bemidji Climate

Run Desc.	Energy Metric	R-0	Location Independent			Exterior			IntExt Top		
			R-5	R-10	R-15	R-5	R-10	R-15	R-5	R-10	R-15
BE_{opt} BG Exposure	Net source energy (GJ)	294.04	275.01	268.14	263.41	Not applicable	Cannot be modeled in BE _{opt}	Cannot be modeled in BE _{opt}	Cannot be modeled in BE _{opt}	Cannot be modeled in BE _{opt}	Cannot be modeled in BE _{opt}
	Source energy savings	0.00%	6.47%	8.81%	10.42%						
	Net site energy (GJ)	205.18	187.54	181.02	176.48						
	Site energy savings	0.00%	8.60%	11.78%	13.99%						
	Nonbasement annual heating (kWh)	26552.61	24867.25	2,068.11	23450.92						
	Nonbasement annual cooling (kWh)	774.45	1,119.18	1,323.62	1493.38						
	Total nonbasement energy (kWh)	27327.06	25986.43	2,391.73	24944.30						
	Total nonbasement energy savings	0.00%	4.91%	7.08%	8.72%						
	Nonbasement energy demand fraction	85.83%	92.44%	94.72%	96.22%						
	Basement annual heating (kWh)	4456.39	,064.52	,356.47	926.90						
	Basement annual cooling (kWh)	56.34	61.96	59.52	53.49						
	Total basement energy (kWh)	4512.73	2126.48	,415.99	980.39						
	Total basement energy savings	0.00%	52.88%	68.62%	78.28%						
	Basement energy demand fraction	14.17%	7.56%	5.28%	3.78%						

Table 8 (continued). Two-Story 2009 Minnesota Energy Code Reference House With Full Basement for Bemidji Climate

Run Desc.	Energy Metric	R-0	Interior			Exterior			IntExt Top		
			R-5	R-10	R-15	R-5	R-10	R-15	R-5	R-10	R-15
EnergyPlus/BUFETS BG Exposure	Net source energy (GJ)	277.15	269.30	265.18	263.21	270.08	266.50	264.65	267.52	264.23	262.58
	Source energy savings	0.00%	2.83%	4.32%	5.03%	2.55%	3.84%	4.51%	3.47%	4.66%	5.26%
	Net site energy (GJ)	185.40	178.66	175.04	173.30	179.40	176.27	174.64	177.12	174.23	172.77
	Site energy savings	0.00%	3.64%	5.59%	6.53%	3.24%	4.92%	5.80%	4.47%	6.02%	6.81%
	Nonbasement annual heating (kWh)	22889.36	22668.22	22436.64	22309.42	22745.75	22555.11	22444.58	22608.17	22401.58	22284.78
	Nonbasement annual cooling (kWh)	2786.00	2816.08	2860.11	2884.86	2787.50	2819.58	2839.42	2823.33	2864.17	2887.47
	Total nonbasement energy (kWh)	25675.36	25484.31	25296.75	25194.28	25533.25	25374.69	25284.00	25431.50	25265.75	25172.25
	Total nonbasement energy savings	0.00%	0.74%	1.47%	1.87%	0.55%	1.17%	1.52%	0.95%	1.60%	1.96%
	Nonbasement energy demand fraction	88.64%	93.12%	95.30%	96.34%	92.80%	94.70%	95.68%	94.17%	95.88%	96.73%
	Basement annual heating (kWh)	2963.78	1686.36	1110.39	848.86	1777.34	1268.64	1016.54	1406.56	964.21	754.21
	Basement annual cooling (kWh)	327.58	196.89	137.97	109.07	202.94	152.29	125.63	166.61	120.78	97.43
	Total basement energy (kWh)	3291.35	1883.25	1248.36	957.93	1980.28	1420.93	1142.17	1573.18	1084.99	851.64
	Total basement energy savings	0.00%	42.78%	62.07%	70.90%	39.83%	56.83%	65.30%	52.20%	67.04%	74.12%
	Basement energy demand fraction	11.36%	6.88%	4.70%	3.66%	7.20%	5.30%	4.32%	5.83%	4.12%	3.27%
EnergyPlus/BUFETS AGBG Exposure	Net source energy (GJ)	283.82	270.67	265.92	263.70	271.32	267.07	264.98	267.68	264.34	262.95
	Source energy savings	0.00%	4.63%	6.31%	7.09%	4.40%	5.90%	6.64%	5.69%	6.86%	7.35%
	Net site energy (GJ)	190.85	179.65	175.53	173.60	180.24	176.56	174.75	177.11	174.19	172.97
	Site energy savings	0.00%	5.87%	8.03%	9.04%	5.56%	7.49%	8.44%	7.20%	8.73%	9.37%
	Nonbasement annual heating (kWh)	22928.28	22639.25	22409.39	22286.11	22698.39	22504.19	22394.56	22559.86	22364.25	22240.56
	Nonbasement annual cooling (kWh)	2868.94	2890.22	2920.00	2935.58	2876.17	2903.06	2919.47	2892.17	2922.00	2935.92
	Total nonbasement energy (kWh)	25797.22	25529.47	25329.39	25221.69	25574.56	25407.25	25314.03	25452.03	25286.25	25176.47
	Total nonbasement energy savings	0.00%	1.04%	1.81%	2.23%	0.86%	1.51%	1.87%	1.34%	1.98%	2.41%
	Nonbasement energy demand fraction	84.90%	92.20%	94.78%	95.99%	91.95%	94.26%	95.41%	94.01%	95.78%	96.36%
	Basement annual heating (kWh)	4108.19	1921.17	1233.94	929.30	1994.58	1369.69	1074.83	1440.26	983.74	839.33
	Basement annual cooling (kWh)	481.49	238.12	160.81	124.26	245.07	176.31	142.04	181.28	129.47	113.04
	Total basement energy (kWh)	4589.68	2159.29	1394.75	1053.56	2239.64	1546.00	1216.88	1621.54	1113.21	952.37
	Total basement energy savings	0.00%	52.95%	69.61%	77.05%	51.20%	66.32%	73.49%	64.67%	75.75%	79.25%
	Basement energy demand fraction	15.10%	7.80%	5.22%	4.01%	8.05%	5.74%	4.59%	5.99%	4.22%	3.64%

Table 9. Two-Story 2009 Minnesota Energy Code Reference House With Full Basement for Minneapolis Climate

Run Desc.	Energy Metric	R-0	Interior			Exterior			IntExt Top		
			R-5	R-10	R-15	R-5	R-10	R-15	R-5	R-10	R-15
BEopt BG Exposure	Net source energy (GJ)	272.36	256.48	250.93	247.24	Not applicable	Cannot be modeled in BEopt	R-5	R-10	R-15	
	Source energy savings	0.00%	5.83%	7.87%	9.22%						
	Net site energy (GJ)	183.00	167.91	162.42	158.69						
	Site energy savings	0.00%	8.25%	11.25%	13.28%						
	Nonbasement annual heating (kWh)	21717.14	20350.17	19701.00	19131.75						
	Nonbasement annual cooling (kWh)	1800.58	2303.04	2588.18	2812.53						
	Total nonbasement energy (kWh)	23517.71	22653.21	22289.18	21944.28						
	Total nonbasement energy savings	0.00%	3.68%	5.22%	6.69%						
	Nonbasement energy demand fraction	85.06%	91.89%	94.27%	95.42%						
	Basement annual heating (kWh)	3952.22	1842.38	1215.73	921.84						
	Basement annual cooling (kWh)	178.44	156.09	138.99	131.21						
	Total basement energy (kWh)	4130.67	1998.47	1354.72	1053.04						
	Total basement energy savings	0.00%	51.62%	67.20%	74.51%						
	Basement energy demand fraction	14.94%	8.11%	5.73%	4.58%						

Table 9 (continued). Two-Story 2009 Minnesota Energy Code Reference House With Full Basement for Minneapolis Climate

Run Desc.	Energy Metric	R-0	Interior			Exterior			IntExt Top		
			R-5	R-10	R-15	R-5	R-10	R-15	R-5	R-10	R-15
Energy Plus/BUFETS BG Exposure	Net source energy (GJ)	260.55	253.80	250.24	248.91	254.43	251.33	249.76	252.24	249.40	248.55
	Source energy savings	0.00%	2.59%	3.96%	4.47%	2.35%	3.54%	4.14%	3.19%	4.28%	4.61%
	Net site energy (GJ)	167.02	161.35	158.26	157.08	161.96	159.29	157.93	160.04	157.56	156.77
	Site energy savings	0.00%	3.39%	5.24%	5.95%	3.03%	4.63%	5.44%	4.18%	5.66%	6.14%
	Nonbasement annual heating (kWh)	18944.36	18739.39	18534.14	18405.58	18805.97	18635.08	18535.00	18681.31	18500.36	18373.44
	Nonbasement annual cooling (kWh)	4124.50	4163.86	4217.25	4244.33	4130.33	4169.64	4193.33	4171.86	4221.64	4245.64
	Total nonbasement energy (kWh)	23068.86	22903.25	22751.39	22649.92	22936.31	22804.72	22728.33	22853.17	22722.00	22619.08
	Total nonbasement energy savings	0.00%	0.72%	1.38%	1.82%	0.57%	1.15%	1.48%	0.94%	1.50%	1.95%
	Nonbasement energy demand fraction	88.82%	93.12%	95.25%	95.84%	92.82%	94.66%	95.58%	94.13%	95.81%	95.98%
	Basement annual heating (kWh)	2418.43	1397.70	927.89	799.31	1470.28	1057.76	859.59	1173.21	810.66	768.33
	Basement annual cooling (kWh)	484.01	295.65	207.87	184.56	303.98	228.97	191.09	251.61	182.98	178.25
	Total basement energy (kWh)	2902.44	1693.34	1135.76	983.87	1774.25	1286.73	1050.68	1424.82	993.65	946.58
	Total basement energy savings	0.00%	41.66%	60.87%	66.10%	38.87%	55.67%	63.80%	50.91%	65.77%	67.39%
	Basement energy demand fraction	11.18%	6.88%	4.75%	4.16%	7.18%	5.34%	4.42%	5.87%	4.19%	4.02%
Energy Plus/BUFETS AGBG Exposure	Net source energy (GJ)	266.27	255.09	250.91	249.37	255.59	251.88	250.08	252.44	249.51	248.69
	Source energy savings	0.00%	4.20%	5.77%	6.35%	4.01%	5.40%	6.08%	5.19%	6.29%	6.60%
	Net site energy (GJ)	171.47	162.22	158.68	157.35	162.69	159.55	158.01	160.05	157.54	156.79
	Site energy savings	0.00%	5.39%	7.46%	8.23%	5.12%	6.95%	7.85%	6.66%	8.12%	8.56%
	Nonbasement annual heating (kWh)	18980.08	18711.00	18509.03	18383.81	18762.50	18589.39	18491.44	18637.36	18467.31	18344.61
	Nonbasement annual cooling (kWh)	4227.89	4244.33	4279.94	4296.00	4224.86	4255.86	4274.14	4239.22	4276.17	4290.94
	Total nonbasement energy (kWh)	23207.97	22955.33	22788.97	22679.81	22987.36	22845.25	22765.58	22876.58	22743.47	22635.56
	Total nonbasement energy savings	0.00%	1.09%	1.81%	2.28%	0.95%	1.56%	1.91%	1.43%	2.00%	2.47%
	Nonbasement energy demand fraction	85.28%	92.18%	94.73%	95.47%	91.96%	94.23%	95.33%	93.94%	95.71%	95.85%
	Basement annual heating (kWh)	3307.64	1593.60	1028.88	868.61	1648.30	1139.83	904.58	1205.21	827.62	792.34
	Basement annual cooling (kWh)	697.21	352.70	238.70	206.38	360.31	259.89	211.14	269.40	193.00	188.83
	Total basement energy (kWh)	4004.85	1946.31	1267.58	1075.00	2008.60	1399.71	1115.71	1474.61	1020.62	981.17
	Total basement energy savings	0.00%	51.40%	68.35%	73.16%	49.85%	65.05%	72.14%	63.18%	74.52%	75.50%
	Basement energy demand fraction	14.72%	7.82%	5.27%	4.53%	8.04%	5.77%	4.67%	6.06%	4.29%	4.15%

Table 10. Two-Story 2009 Minnesota Energy Code Reference House With Full Basement for Janesville Climate

Run Desc.	Energy Metric	R-0	Interior			Exterior			IntExt Top				
			R-5	R-10	R-15	R-5	R-10	R-15	R-5	R-10	R-15		
BEopt BG Exposure	Net source energy (GJ)	242.32	226.38	220.71	217.10	Not applicable	Cannot be modeled in BEopt	Cannot be modeled in BEopt	Cannot be modeled in BEopt	Cannot be modeled in BEopt	Cannot be modeled in BEopt	Cannot be modeled in BEopt	Cannot be modeled in BEopt
	Source energy savings	0.00%	6.58%	8.92%	10.41%								
	Net site energy (GJ)	160.08	145.38	140.03	136.55								
	Site energy savings	0.00%	9.18%	12.52%	14.70%								
	Nonbasement annual heating (kWh)	17474.39	16194.17	15592.69	15012.25								
	Nonbasement annual cooling (kWh)	498.12	752.86	904.78	1027.91								
	Total nonbasement energy (kWh)	17972.51	16947.02	16497.47	16040.16								
	Total nonbasement energy savings	0.00%	5.71%	8.21%	10.75%								
	Nonbasement energy demand fraction	82.19%	90.30%	93.25%	94.16%								
	Basement annual heating (kWh)	3837.64	1759.99	1138.20	933.78								
	Basement annual cooling (kWh)	56.38	59.53	56.04	60.67								
	Total basement energy (kWh)	3894.02	1819.53	1194.24	994.45								
	Total basement energy savings	0.00%	53.27%	69.33%	74.46%								
	Basement energy demand fraction	17.81%	9.70%	6.75%	5.84%								

Table 10 (continued). Two-Story 2009 Minnesota Energy Code Reference House With Full Basement for Janesville Climate

Run Desc.	Energy Metric	R-0	Interior			Exterior			IntExt Top		
			R-5	R-10	R-15	R-5	R-10	R-15	R-5	R-10	R-15
Energy Plus/BUFETS BG Exposure	Net source energy (GJ)	234.85	233.63	232.38	231.68	233.40	232.52	231.93	233.09	232.07	231.47
	Net site energy (GJ)	149.05	147.85	146.62	145.93	147.75	146.89	146.31	147.37	146.34	145.73
	Nonbasement annual heating (kWh)	15020.14	14619.03	14345.00	14204.64	14760.11	14524.97	14399.17	14539.22	14300.58	14174.81
	Nonbasement annual cooling (kWh)	2168.26	2173.55	2196.66	2209.95	2162.43	2179.05	2189.78	2176.21	2198.04	2210.77
	Total nonbasement energy (kWh)	17188.39	16792.58	16541.66	16414.59	16922.54	16704.02	16588.95	16715.43	16498.63	16385.58
	Basement annual heating (kWh)	3287.64	3473.33	3469.56	3453.19	3170.06	3198.86	3189.33	3439.61	3449.25	3438.33
	Basement annual cooling (kWh)	430.12	477.57	504.03	516.95	429.58	454.22	465.18	479.17	504.75	517.23
	Total basement energy (kWh)	3717.76	3950.90	3973.58	3970.14	3599.64	3653.08	3654.51	3918.78	3954.00	3955.56
Energy Plus/BUFETS AGBG Exposure	Net source energy (GJ)	236.25	233.89	232.50	231.76	233.28	232.09	231.45	233.10	232.08	231.47
	Net site energy (GJ)	150.08	147.90	146.55	145.84	147.46	146.34	145.74	147.17	146.17	145.59
	Nonbasement annual heating (kWh)	15118.11	14596.31	14320.67	14182.22	14713.36	14477.92	14351.94	14480.89	14257.58	14140.03
	Nonbasement annual cooling (kWh)	2241.45	2233.74	2244.86	2250.64	2230.55	2241.88	2248.93	2230.03	2242.55	2248.97
	Total nonbasement energy (kWh)	17359.56	16830.05	16565.53	16432.86	16943.91	16719.79	16600.88	16710.91	16500.13	16388.99
	Basement annual heating (kWh)	3346.81	3500.67	3480.31	3458.22	3223.89	3192.50	3176.83	3465.83	3458.17	3442.03
	Basement annual cooling (kWh)	468.22	514.07	533.45	541.79	471.68	487.14	496.11	515.34	533.81	541.90
	Total basement energy (kWh)	3815.03	4014.73	4013.75	4000.01	3695.57	3679.64	3672.94	3981.18	3991.98	3983.93

Note: As explained in Section 4.3, the algorithm succeeds where the values are shaded in green and fails for those values shaded in red.

Table 11. Two-Story 2009 Minnesota Energy Code Reference House With Full Basement for Madison Climate Using Janesville Foundation Performance Library

Run Desc.	Energy Metric	R-0	Interior			Exterior			IntExt Top		
			R-5	R-10	R-15	R-5	R-10	R-15	R-5	R-10	R-15
BEopt BG Exposure	Net source energy (GJ)	269.77	253.30	247.54	243.63	Not applicable	Not applicable	Not applicable	Not applicable	Cannot be modeled in BEopt	Cannot be modeled in BEopt
	Source energy savings	0.00%	6.11%	8.24%	9.69%						
	Net site energy (GJ)	181.06	165.44	159.77	155.86						
	Site energy savings	0.00%	8.63%	11.76%	13.92%						
	Nonbasement annual heating (kWh)	21086.14	19739.39	19095.92	18594.50						
	Nonbasement annual cooling (kWh)	1604.76	2086.03	2358.89	2583.28						
	Total nonbasement energy (kWh)	22690.90	21825.42	21454.81	21177.78						
	Total nonbasement energy savings	0.00%	3.81%	5.45%	6.67%						
	Nonbasement energy demand fraction	83.97%	91.27%	93.83%	95.52%						
	Basement annual heating (kWh)	4177.06	1940.30	1277.85	875.77						
	Basement annual cooling (kWh)	155.79	146.68	133.81	116.61						
	Total basement energy (kWh)	4332.85	2086.98	1411.66	992.38						
	Total basement energy savings	0.00%	51.83%	67.42%	77.10%						
	Basement energy demand fraction	16.03%	8.73%	6.17%	4.48%						

Table 11 (continued). Two-Story 2009 Minnesota Energy Code Reference House With Full Basement for Madison Climate Using Janesville Foundation Performance Library

Run Desc.	Energy Metric	R0	Interior			Exterior			Int+Ext Top		
			R-5	R-10	R-15	R-5	R-10	R-15	R-5	R-10	R-15
EnergyPlus/BUFETS BG Exposure	Net source energy (GJ)	255.19	251.55	249.15	248.57	252.30	250.24	249.14	250.69	248.68	262.95
	Source energy savings	0.00%	1.43%	2.37%	2.59%	1.13%	1.94%	2.37%	1.76%	2.55%	-3.04%
	Net site energy (GJ)	161.23	158.10	155.96	155.38	158.80	156.98	156.00	157.36	155.56	172.97
	Site energy savings	0.00%	1.94%	3.27%	3.63%	1.51%	2.64%	3.24%	2.40%	3.52%	-7.28%
	Nonbasement annual heating (kWh)	18547.94	18335.94	18137.89	18005.53	18406.56	18244.47	18151.42	18274.61	18102.61	22240.56
	Nonbasement annual cooling (kWh)	4505.61	4554.61	4615.53	4644.31	4522.97	4570.42	4599.08	4565.58	4621.61	2935.92
	Total nonbasement energy (kWh)	23053.56	22890.56	22753.42	22649.83	22929.53	22814.89	22750.50	22840.19	22724.22	25176.47
	Total nonbasement energy savings	0.00%	0.71%	1.30%	1.75%	0.54%	1.04%	1.31%	0.93%	1.43%	-9.21%
	Nonbasement energy demand fraction	93.14%	95.28%	96.58%	96.50%	94.88%	96.00%	96.59%	95.75%	96.83%	96.36%
	Basement annual heating (kWh)	1386.63	916.78	644.02	651.63	1002.16	763.20	640.03	816.65	592.08	839.33
	Basement annual cooling (kWh)	311.11	217.76	162.52	169.47	234.47	187.97	162.33	196.96	150.67	113.04
	Total basement energy (kWh)	1697.74	1134.53	806.54	821.10	1236.63	951.17	802.36	1013.61	742.74	952.37
	Total basement energy savings	0.00%	33.17%	52.49%	51.64%	27.16%	43.97%	52.74%	40.30%	56.25%	43.90%
Basement energy demand fraction	6.86%	4.72%	3.42%	3.50%	5.12%	4.00%	3.41%	4.25%	3.17%	3.64%	
EnergyPlus/BUFETS AGBG Exposure	Net source energy (GJ)	262.04	253.45	250.45	249.52	254.10	251.26	249.85	251.50	249.24	249.32
	Source energy savings	0.00%	3.28%	4.42%	4.78%	3.03%	4.11%	4.65%	4.02%	4.88%	4.85%
	Net site energy (GJ)	166.46	159.37	156.80	155.97	159.96	157.54	156.33	157.78	155.83	155.80
	Site energy savings	0.00%	4.26%	5.80%	6.30%	3.90%	5.36%	6.09%	5.21%	6.39%	6.40%
	Nonbasement annual heating (kWh)	18567.42	18312.22	18109.33	17981.72	18371.19	18208.50	18117.31	18239.86	18077.39	17935.61
	Nonbasement annual cooling (kWh)	4639.75	4673.50	4711.39	4726.56	4653.97	4690.42	4712.47	4671.53	4711.31	4720.61
	Total nonbasement energy (kWh)	23207.17	22985.72	22820.72	22708.28	23025.17	22898.92	22829.78	22911.39	22788.69	22656.22
	Total nonbasement energy savings	0.00%	0.95%	1.67%	2.15%	0.78%	1.33%	1.63%	1.27%	1.80%	2.37%
	Nonbasement energy demand fraction	88.44%	93.92%	95.58%	95.79%	93.60%	95.30%	96.14%	95.19%	96.48%	95.70%
	Basement annual heating (kWh)	2444.32	1184.55	832.65	783.69	1254.71	892.45	720.35	919.29	654.86	799.00
	Basement annual cooling (kWh)	588.94	303.10	223.04	214.48	318.84	237.26	196.34	237.57	176.36	218.91
	Total basement energy (kWh)	3033.26	1487.65	1055.69	998.17	1573.55	1129.71	916.69	1156.86	831.22	1017.91
	Total basement energy savings	0.00%	50.96%	65.20%	67.09%	48.12%	62.76%	69.78%	61.86%	72.60%	66.44%
Basement energy demand fraction	11.56%	6.08%	4.42%	4.21%	6.40%	4.70%	3.86%	4.81%	3.52%	4.30%	

Note: The absolute values are incorrect; however, the trends are correct except for the values shaded in red.

**Table 12. Single-Story Bungalow in Compliance With 2009 Minnesota Energy Code
With Passive Crawlspace for Bemidji**

Run Desc.	Energy Metric	R-0	Interior		
			R-5	R-10	R-15
BEopt BG Exposure	Net source energy (GJ)	201.80	185.78	181.92	179.38
	Source energy savings	0.00%	7.94%	9.85%	11.11%
	Net site energy (GJ)	145.91	131.06	127.44	125.09
	Site energy savings	0.00%	10.18%	12.66%	14.27%
	Living space annual heating (kWh)	21238.94	18111.69	17350.17	16843.03
	Living space annual cooling (kWh)	754.77	1061.31	1158.46	1210.41
	Total living space energy (kWh)	21993.71	19173.00	18508.63	18053.44
	Total living space energy savings	0.00%	12.83%	15.85%	17.92%
EnergyPlus/BUFETS BG Exposure	Net source energy (GJ)	192.35	187.07	184.80	183.71
	Source energy savings	0.00%	2.74%	3.93%	4.49%
	Net site energy (GJ)	132.99	128.28	126.21	125.21
	Site energy savings	0.00%	3.54%	5.10%	5.85%
	Living space annual heating (kWh)	17872.83	16867.53	16420.42	16204.67
	Living space annual cooling (kWh)	3002.67	3018.28	3048.33	3065.03
	Total living space energy (kWh)	20875.50	19885.81	19468.75	19269.69
	Total living space energy savings	0.00%	4.74%	6.74%	7.69%
EnergyPlus/BUFETS AGBG Exposure	Net source energy (GJ)	192.28	186.68	184.52	183.49
	Source energy savings	0.00%	2.91%	4.04%	4.57%
	Net site energy (GJ)	132.78	127.82	125.87	124.94
	Site energy savings	0.00%	3.74%	5.20%	5.90%
	Living space annual heating (kWh)	17814.14	16758.47	16340.83	16140.83
	Living space annual cooling (kWh)	3076.72	3077.11	3094.08	3102.72
	Total living space energy (kWh)	20890.86	19835.58	19434.92	19243.56
	Total living space energy savings	0.00%	5.05%	6.97%	7.89%

**Table 13. Single-Story Bungalow in Compliance With 2009 Minnesota Energy Code
With Passive Crawlspace for Minneapolis**

Run Desc.	Energy Metric	R-0	Interior		
			R-5	R-10	R-15
BEopt BG Exposure	Net source energy (GJ)	184.06	173.60	171.25	169.97
	Source energy savings	0.00%	5.68%	6.96%	7.66%
	Net site energy (GJ)	128.31	118.44	116.19	114.96
	Site energy savings	0.00%	7.69%	9.45%	10.40%
	Living space annual heating (kWh)	17147.06	15067.19	14588.28	14324.94
	Living space annual cooling (kWh)	1524.76	1808.68	1886.46	1931.78
	Total living space energy (kWh)	18671.82	16875.88	16474.73	16256.72
	Total living space energy savings	0.00%	9.62%	11.77%	12.93%
EnergyPlus/BUFETS BG Exposure	Net source energy (GJ)	170.34	165.55	163.99	163.28
	Source energy savings	0.00%	2.81%	3.73%	4.14%
	Net site energy (GJ)	110.72	106.42	105.00	104.34
	Site energy savings	0.00%	3.88%	5.17%	5.76%
	Living space annual heating (kWh)	12705.75	11786.56	11479.42	11336.92
	Living space annual cooling (kWh)	4324.08	4348.83	4368.81	4379.11
	Total living space energy (kWh)	17029.83	16135.39	15848.22	15716.03
	Total living space energy savings	0.00%	5.25%	6.94%	7.71%
EnergyPlus/BUFETS AGBG Exposure	Net source energy (GJ)	170.74	165.61	164.03	163.30
	Source energy savings	0.00%	3.00%	3.93%	4.36%
	Net site energy (GJ)	110.88	106.36	104.95	104.30
	Site energy savings	0.00%	4.08%	5.35%	5.93%
	Living space annual heating (kWh)	12715.28	11761.28	11459.69	11319.89
	Living space annual cooling (kWh)	4403.61	4401.33	4407.69	4410.56
	Total living space energy (kWh)	17118.89	16162.61	15867.39	15730.44
	Total living space energy savings	0.00%	5.59%	7.31%	8.11%

Table 14. Single-Story Bungalow in Compliance With 2009 Minnesota Energy Code With Passive Crawlspace for Janesville

Run Desc.	Energy Metric	R-0	Interior		
			R-5	R-10	R-15
BEopt BG Exposure	Net source energy (GJ)	165.23	154.74	152.36	151.07
	Source energy savings	0.00%	6.35%	7.79%	8.57%
	Net site energy (GJ)	113.94	104.22	102.01	100.80
	Site energy savings	0.00%	8.53%	10.47%	11.53%
	Living space annual heating (kWh)	14564.94	12503.19	12028.97	11769.53
	Living space annual cooling (kWh)	592.37	784.20	837.05	867.94
	Total living space energy (kWh)	15157.32	13287.39	12866.02	12637.47
	Total living space energy savings	0.00%	12.34%	15.12%	16.62%
EnergyPlus/BUFETS BG Exposure	Net source energy (GJ)	159.11	154.78	153.39	152.75
	Source energy savings	0.00%	2.72%	3.59%	4.00%
	Net site energy (GJ)	104.53	100.64	99.37	98.79
	Site energy savings	0.00%	3.72%	4.94%	5.49%
	Living space annual heating (kWh)	12052.81	11211.14	10935.31	10807.11
	Living space annual cooling (kWh)	2535.87	2566.66	2585.64	2595.23
	Total living space energy (kWh)	14588.67	13777.80	13520.95	13402.34
	Total living space energy savings	0.00%	5.56%	7.32%	8.13%
EnergyPlus/BUFETS AGBG Exposure	Net source energy (GJ)	159.39	154.81	153.41	152.76
	Source energy savings	0.00%	2.87%	3.75%	4.16%
	Net site energy (GJ)	104.66	100.57	99.32	98.74
	Site energy savings	0.00%	3.91%	5.10%	5.66%
	Living space annual heating (kWh)	12064.81	11185.11	10914.22	10788.83
	Living space annual cooling (kWh)	2597.42	2614.94	2623.00	2626.36
	Total living space energy (kWh)	14662.23	13800.05	13537.22	13415.19
	Total living space energy savings	0.00%	5.88%	7.67%	8.51%

buildingamerica.gov

U.S. DEPARTMENT OF
ENERGY | Energy Efficiency &
Renewable Energy

DOE/GO-102013-3844 • April 2013

Printed With Wisconsin a renewable-source ink on paper containing at least 50% wastepaper, including 10% post-consumer waste.