

## Building America Best Practices Series: Volume 5



### Builders and Buyers Handbook for Improving New Home Efficiency, Comfort, and Durability in the Marine Climate



# Building America Best Practices Series: Volume 5

Builders and Buyers Handbook for Improving New Home Efficiency, Comfort, and Durability in the Marine Climate

Prepared by

**Pacific Northwest National Laboratory**

Michael C. Baechler

Z. Todd Taylor, Rosemarie Bartlett, Theresa Gilbride, Marye Hefty, Heidi Steward

and

**Oak Ridge National Laboratory**

Pat M. Love

Jennifer A. Palmer

## DISCLAIMER

*This report was prepared as an account of work sponsored by an agency of the United States Government. Neither the United States Government nor any agency thereof, nor Battelle Memorial Institute, nor any of their employees, makes any warranty, express or implied, or assumes any legal liability or responsibility for the accuracy, completeness, or usefulness of any information, apparatus, product, or process disclosed, or represents that its use would not infringe privately owned rights. Reference herein to any specific commercial product, process, or service by trade name, trademark, manufacturer, or otherwise does not necessarily constitute or imply its endorsement, recommendation, or favoring by the United States Government or any agency thereof, or Battelle Memorial Institute. The views and opinions of authors expressed herein do not necessarily state or reflect those of the United States Government or any agency thereof.*

## INTRODUCTION

*Taking action in your community*



### HOMEOWNERS

*Shopping for value, comfort, and quality*



### MANAGERS

*Putting building science to work for your bottom line*



### MARKETERS

*Energy efficiency delivers the value that customers demand*



### SITE PLANNERS & DEVELOPERS

*Properly situated houses pay big dividends*



### DESIGNERS

*Well-crafted designs capture benefits for builders, buyers, and business*



### SITE SUPERVISORS

*Tools to help with project management*



### TRADES

*Professional tips for fast and easy installation*

## CASE STUDIES

*Bringing it all together*



# CONTENTS

<b>Introduction</b> .....	INT-1
<b>Homeowners</b> .....	HOM-1
Quick Tips: Homeowners .....	HOM-1
You're in Good Company .....	HOM-1
How Quality Houses Perform .....	HOM-2
An Energy-Efficient Home Will Cost You Less .....	HOM-3
Energy-Efficient Mortgages Can Help You Get More for Your Money .....	HOM-3
What's the Score? (HERS Index) .....	HOM-5
Guaranteed Energy Costs and Comfort .....	HOM-6
And There's More - More Green for You and More Green for the Planet .....	HOM-6
What to Look For .....	HOM-6
Sources and Additional Information .....	HOM-7
Homebuyer's Checklist .....	HOM-7
<b>Managers</b> .....	MNG-1
An Invitation to Building Company Managers .....	MNG-1
Building America .....	MNG-1
Quick Tips: Managers .....	MNG-1
The Business Case for Building Science and Energy Efficiency .....	MNG-2
Properly Choosing Materials and Equipment .....	MNG-2
Reduced Risks, Increased Productivity, and Fewer Callbacks .....	MNG-3
From an Economic Standpoint, Everyone Wins .....	MNG-3
Customer Satisfaction and Referrals .....	MNG-3
Consumers Expect More .....	MNG-4
Competitive Advantage in the Marketplace .....	MNG-4
Take the Next Step .....	MNG-5
Case Studies .....	MNG-5
Sources and Additional Information .....	MNG-5
<b>Marketers</b> .....	MKT-1
ENERGY STAR Qualified Homes: Telling Your Story .....	MKT-1
Quick Tips: Marketers .....	MKT-1
Increase Customer Satisfaction and Let Your Customers Sell Your Product .....	MKT-2
Sell the Value that Home Buyers Expect .....	MKT-2
How Industry Leaders Sell Energy-Efficient Homes .....	MKT-2
Sources and Additional Information .....	MKT-4

## INTRODUCTION

*Taking action in your community*



### HOMEOWNERS

*Shopping for value, comfort, and quality*



### MANAGERS

*Putting building science to work for your bottom line*



### MARKETERS

*Energy efficiency delivers the value that customers demand*



### SITE PLANNERS & DEVELOPERS

*Properly situated houses pay big dividends*



### DESIGNERS

*Well-crafted designs capture benefits for builders, buyers, and business*



### SITE SUPERVISORS

*Tools to help with project management*



### TRADES

*Professional tips for fast and easy installation*

## CASE STUDIES

*Bringing it all together*



# CONTENTS

<b>Site Planners</b> .....	PLN-1
Lot Orientation .....	PLN-1
Quick Tips: Site Planners .....	PLN-1
Shade Trees .....	PLN-3
Other Steps .....	PLN-4
Sources and Additional Information .....	PLN-7
<b>Designers</b> .....	DES-1
Quick Tips: Designers .....	DES-1
Building Science and the Systems Approach .....	DES-1
The Cost of Doing Business .....	DES-3
Marine Climate .....	DES-5
Design Best Practices for Marine Climate .....	DES-6
Site - Drainage, Pest Control, and Landscaping .....	DES-6
Foundation System Moisture and Soil Gas Control .....	DES-7
Structural Moisture Control .....	DES-10
Structural Air Sealing .....	DES-16
Structural Thermal Performance .....	DES-17
Heating, Ventilating, and Air Conditioning (HVAC) .....	DES-26
Mechanicals Management and Appliances .....	DES-35
Sources and Additional Information .....	DES-37
<b>Site Supervisors</b> .....	SUP-1
Managing Expectations .....	SUP-1
Develop a Work Plan .....	SUP-2
Plans - Get Them Right .....	SUP-2
Plans - Keep Them Right .....	SUP-2
Contracts - Write Them Down .....	SUP-3
Pre-Construction Meeting - Have One .....	SUP-4
Permits - Grease the Skids .....	SUP-4
Managing Execution .....	SUP-5
Training .....	SUP-5
Scheduling .....	SUP-6
Quality Assurance .....	SUP-7
Spot-Check Inspection Checklist .....	SUP-8
Pre-Drywall Inspection Checklist .....	SUP-9
Pre-Occupancy Inspection Checklist .....	SUP-10
Sources and Additional Information .....	SUP-11

# CONTENTS

<b>Trades</b> .....	TRD-1
Slab Insulation - Marine Climates .....	TRD-2
Basement & Conditioned (Unvented) Crawlspace Insulation .....	TRD-4
Housewrap .....	TRD-6
Window Flashing .....	TRD-7
Air Sealing - Plumbing .....	TRD-9
Air Sealing - Electrical .....	TRD-10
Air Sealing - Drywall .....	TRD-11
Air Sealing Glossary .....	TRD-12
Fiberglass Insulation .....	TRD-13
Masonry Construction .....	TRD-14
Radiant Barriers .....	TRD-15
Duct Sealing .....	TRD-16
<b>Case Study: Ft. Lewis</b> .....	CASE A-1
<b>Case Study: SummerHill Homes</b> .....	CASE B-1
<b>Appendix I: Homebuyer's Checklist</b> .....	APPENDIX I-1
<b>Appendix II: Energy &amp; Housing Glossary</b> .....	APPENDIX II-1
<b>Appendix III: Code Notes</b> .....	APPENDIX III-1
<b>Appendix IV: Counties in the Marine Climate</b> .....	APPENDIX IV-1
<b>Appendix V: Web Site References</b> .....	APPENDIX V-1

# ACKNOWLEDGMENTS

The U.S. Department of Energy's (DOE) Building America program is comprised of public/private partnerships that conduct systems research to improve overall housing performance, increase housing durability and comfort, reduce energy use, and increase energy security for America's homeowners. Program activities focus on finding solutions for both new and existing homes, as well as integrating clean onsite energy systems that will allow the homebuilding industry to provide homes that produce more energy than they use. In addition to the DOE management and staff, the Building America Program includes seven consortia, four national laboratories, and hundreds of builders, manufacturers, and service providers. Building America works closely with the Department of Housing and Urban Development's (HUD) Partnership for Advancing Technology in Housing (PATH) Program, co-manages the ENERGY STAR Program along with the Environmental Protection Agency, and works with other federal agencies to coordinate research findings and disseminate information. These partners make the program a successful source of knowledge and innovation for industry practitioners and government policy makers. Together, these cooperating agencies have provided reviews and shared insightful comments, as well as making the authors aware of their technical libraries.

The U.S. DOE Building America Program funded the development of this series of handbooks. DOE also funded the Building America consortia and national laboratories to form the basis for these best practices. The seven consortia are listed on the back cover of this document. The consortia have taken on the hard work of applied research, field testing, training builders, and transforming the results into building practices. Numerous drawings, descriptions, photos, and case studies originated with the consortia.

Many builders have chosen to use the Building America process in collaboration with the consortia and are quoted in this series of best practices with over a dozen featured in case studies. These builders deserve thankful recognition for contributing to the success of the Building America Program and the *Best Practices Series*.

Building America partners worked diligently on this project to further the cause of efficiency, resource conservation, or improved building performance. These groups have voluntarily supplied technical materials, review comments, or help in distribution. These contributors include Southface Energy Institute; Energy and Environmental Building Association, Wisconsin ENERGY STAR Homes Program; Consortium for Energy Efficiency, Air Conditioning Contractors of America, National Fenestration Rating Council, and National Association of Home Builders. National Association of State Universities and Land Grant Colleges Extension Service Professors from universities throughout the nation provided valuable and in depth contributions. In particular, professors from the following universities devoted their time and shared their insights: University of Kentucky, Cornell University, University of Florida, University of Louisiana; and the University of Minnesota.

This project required coordination among the national laboratories. Pacific Northwest National Laboratory and Oak Ridge National Laboratory have taken the lead at producing this document. The National Renewable Energy Laboratory made its library of Building America documents available to the authors, reviewed the document, and has responsibility for posting the document to the Web. Scientists at Lawrence Berkeley National Laboratory reviewed the document contents.

Christina Van Vleck lent this project her skill as a graphic artist. She prepared all of the original drawings and designed and laid out the overall series of books.

The authors and DOE offer their gratitude to the many contributors that made this project a success.

## INTRODUCTION

*Taking action in your community*



### HOMEOWNERS

*Shopping for value, comfort, and quality*



### MANAGERS

*Putting building science to work for your bottom line*



### MARKETERS

*Energy efficiency delivers the value that customers demand*



### SITE PLANNERS & DEVELOPERS

*Properly situated houses pay big dividends*



### DESIGNERS

*Well-crafted designs capture benefits for builders, buyers, and business*



### SITE SUPERVISORS

*Tools to help with project management*



### TRADES

*Professional tips for fast and easy installation*

## CASE STUDIES

*Bringing it all together*



# WELCOME

## *Taking action in your community*

This best practices guide is part of a series produced by Building America. The guide book is a resource to help builders large and small build high-quality, energy-efficient homes that achieve 30% energy savings in space conditioning and water heating in the marine climate. The savings are in comparison with the 1993 *Model Energy Code*, unless otherwise noted. The guide contains chapters for every member of the builder's team—from the manager to the site planner to the designers, site supervisors, the trades, and marketers. There is also a chapter for homeowners on how to use the book to provide help in selecting a new home or builder.

- **Homeowners** will find how energy-efficient homes package value, comfort, economy, durability, and performance. This chapter is a great introduction to energy-efficient home technologies and provides helpful checklists of what to look for when home shopping.
- **Managers** will learn why building energy-efficient homes makes business sense. They will find out how much consumers value energy efficiency and the quality that comes with it, and how their company can gain market advantage by building energy-efficient homes.
- **Marketers** will learn about great resources for selling energy-efficient homes, including getting plugged into the ENERGY STAR® nationally recognized branding program.
- **Site Planners** will discover the huge impact building orientation, landscaping, and shading can have on energy costs, plus learn tips on moisture management and pest control.
- **Designers** will learn about the systems approach to home design backed up by building science. They will get guidance on key building components for designing energy-efficient homes.
- **Site Supervisors** will get guidance on contract specifications, tips on scheduling and training, and handy checklists for quality assurance and commissioning inspections.
- **Trades** will find step-by-step, easy-to-follow illustrated instructions for adding key energy efficiency technologies.

The last chapter has case studies showing real-life examples of builders who are designing and constructing energy-efficient houses in the marine climate zone.

We designed this guidebook to be taken apart, passed around, and updated. Give the sections of the book to the right people in your organization. Pass on pieces to subcontractors to help them understand your objectives. Copy it as needed.

This first series of guides helps builders understand and implement the Building America process to reach 30% energy savings in space heating and cooling and water heating. Future guides will aim at even higher levels of efficiency based on the latest Building America research, giving builders the knowledge they need to build even more efficient and durable houses.

The practices in this book are intended for the marine climate zone. Visit [www.buildingamerica.gov](http://www.buildingamerica.gov) for information on handbooks covering other climate regions.

## INTRODUCTION

*Taking action in your community*



### HOMEOWNERS

*Shopping for value, comfort, and quality*



### MANAGERS

*Putting building science to work for your bottom line*



### MARKETERS

*Energy efficiency delivers the value that customers demand*



### SITE PLANNERS & DEVELOPERS

*Properly situated houses pay big dividends*



### DESIGNERS

*Well-crafted designs capture benefits for builders, buyers, and business*



### SITE SUPERVISORS

*Tools to help with project management*



### TRADES

*Professional tips for fast and easy installation*

## CASE STUDIES

*Bringing it all together*



# INTRODUCTION

## Marine Climate

The marine climate covers a narrow band paralleling the west coast from the Canadian border south to the county boundary separating Ventura and Los Angeles counties in California. In some stretches, this band is only one county deep inland from the Pacific Ocean. The Marine Climate was designated in recognition of the mild temperatures and moist conditions found along the coast. Housing is diverse across this narrow swath. Slab, crawlspace, and basement foundation systems are all popular. Houses in this climate typically face a heating season of up to 5,000 heating degree days (HDD) and average outdoor temperatures dropping below 45°Fahrenheit in winter. And many areas have moderate to high rainfall.

Designers and builders face the challenge of controlling the infiltration of moisture-laden air into the building envelope and keeping moisture away from cold surfaces where condensation may degrade structural materials and contribute to mold growth. Wall and roof assemblies must accommodate cool moist air along the coast and heavy rains in many areas, and should allow for vapor transfer in two directions.

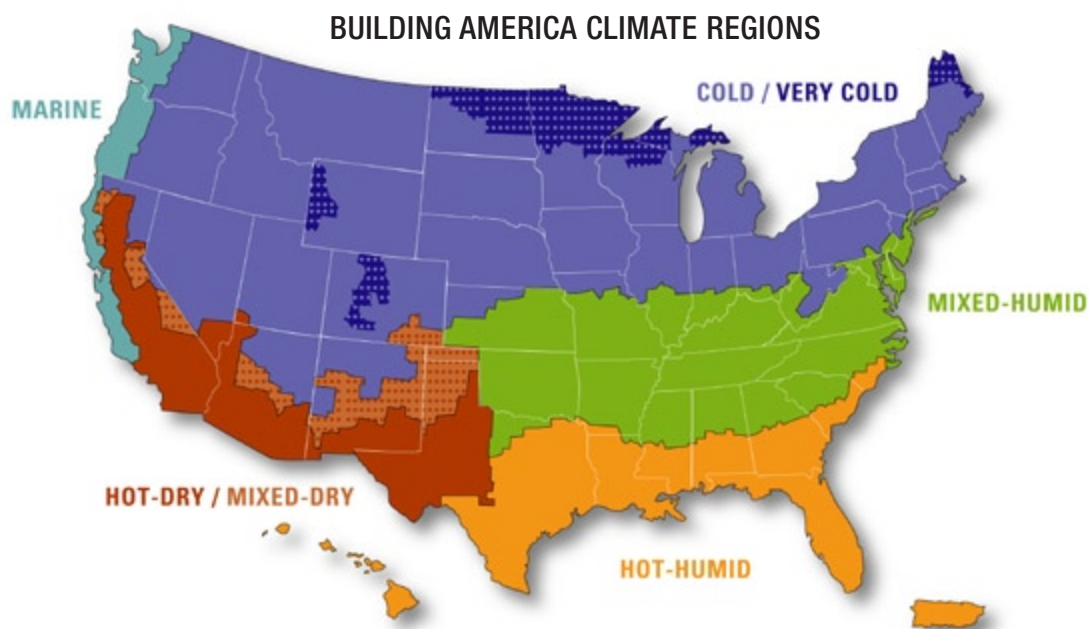

The top map shows the Building America designated climates for most of the country. The bottom map highlights just the marine climate.

## MARINE CLIMATE



## Building America Process

Many builders choose to try out Building America ideas in a prototype house. After building one or a few prototypes they decide what features they will carry forward into their regular construction. This chart shows a process for working with a Home Energy Rating System (HERS) rating professional, an engineer, or an architect to build this first house and on an ongoing basis. The person offering guidance could also be a company designer who has become familiar with this document or has taken other Building America training. An educated staff will be the best means of selecting building science support.



# INTRODUCTION

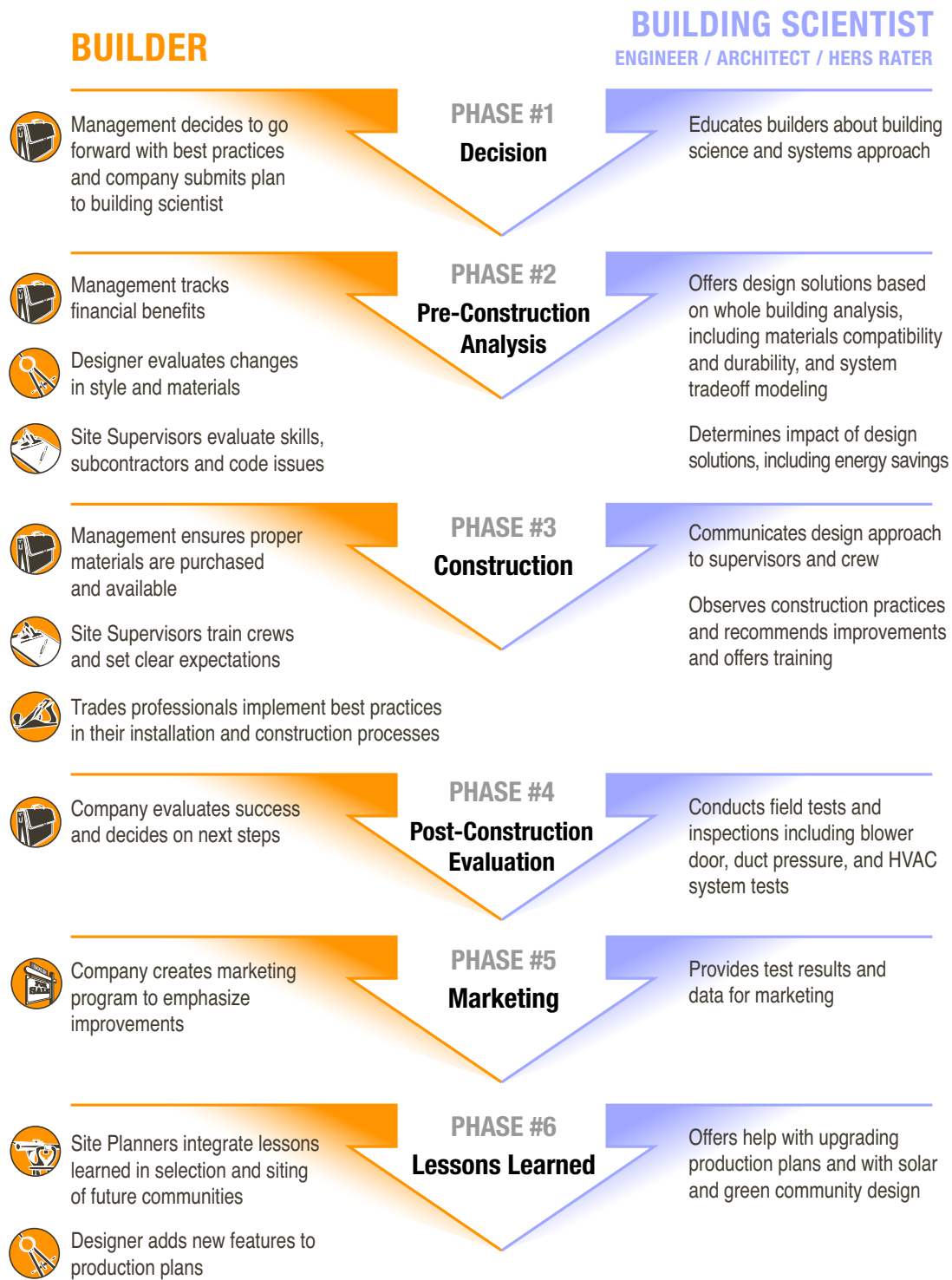

*\*Icons correspond with chapters and company capabilities*

Building America welcomes reader feedback on this second volume of the *Best Practices Series*. Please submit your comments via e-mail to: Michael Baechler ([michael.baechler@pnl.gov](mailto:michael.baechler@pnl.gov)) or Pat Love ([lovepm@ornl.gov](mailto:lovepm@ornl.gov)). You can learn more about Building America and download additional copies of this document at [www.buildingamerica.gov](http://www.buildingamerica.gov).

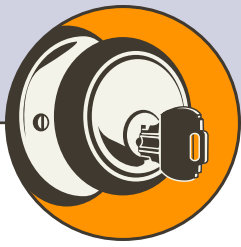

# HOMEOWNERS

## *Shopping for value, comfort, and quality*

Comfort. Economy. Durability. Performance. Some homes force you to choose. Energy-efficient homes deliver it all. And as a homebuyer, you deserve, and should demand, the whole package.

One way to know you have found an energy-efficient home is to look for the ENERGY STAR® label. ENERGY STAR has taken much of the guesswork out of buying new homes and other products. ENERGY STAR-qualified new homes are built to strict energy-efficiency guidelines using proven technologies and construction practices. Your builder also may have incorporated other building features that go beyond ENERGY STAR criteria for even more energy savings, and for greater health and comfort.

ENERGY STAR features should be included in all houses from lower cost starters to high-end customs. This chapter gives you an introduction to the technology that makes these houses work, how much they cost, how to pay for them, and a checklist of what to look for in new homes. The features described here are specifically designed for the marine climate found in the United States.

### **You're in Good Company**

The companies that build ENERGY STAR homes are among the best and largest in the nation. Over 2,000 builders work with ENERGY STAR in the United States. And about 50% of the largest 100 builders in the nation have at least one division

building ENERGY STAR qualified homes. Thousands of small companies also build ENERGY STAR homes. And many of these companies are working with Building America.

In addition to discussing the minimum requirements for attaining ENERGY STAR, this packet suggests other techniques developed within the U.S. Department of Energy's Building America program. These techniques can help you avoid common construction problems that occur in the marine climate. The recommendations in this chapter are based on Building America's building science research on over 25,000 homes in 34 states encompassing every climate region in the nation. Building America works with

### **QUICK TIPS | HOMEOWNERS**

- Look for the ENERGY STAR label for government-endorsed proof that a home is energy efficient.
- Learn why an energy-efficient home is usually a higher quality home all the way around.
- Use the enclosed checklist to shop for energy-efficient homes.
- Use the nationally recognized HERS rating to know just how efficient the homes you are considering really are.
- Own a home you can be proud of —energy-efficient homes are good for the environment.

### INTRODUCTION

*Taking action in your community*



### HOMEOWNERS

*Shopping for value, comfort, and quality*



### MANAGERS

*Putting building science to work for your bottom line*



### MARKETERS

*Energy efficiency delivers the value that customers demand*



### SITE PLANNERS & DEVELOPERS

*Properly situated houses pay big dividends*



### DESIGNERS

*Well-crafted designs capture benefits for builders, buyers, and business*



### SITE SUPERVISORS

*Tools to help with project management*



### TRADES

*Professional tips for fast and easy installation*

### CASE STUDIES

*Bringing it all together*



# HOMEOWNERS

the nation's premier building scientists to conduct research and share knowledge with builders to help build better homes.

If you are looking for energy-saving features in your new home you're in good company. Recent homebuyer surveys have found that energy efficiency is the top upgrade that homebuyers choose in new homes (Johnston 2000). And homebuyers in Phoenix rated energy efficiency as the number one reason related to the house itself that influenced their satisfaction with the builder recognized by *Professional Builder* magazine as having the top customer satisfaction in the nation (2003). This same builder won the J.D. Powers and Associates top ranking for customer satisfaction in 12 of 21 markets in the United States. The winner, Pulte Homes, is a Building America Partner that brands its homes using ENERGY STAR. Centex, a Building America partner, was rated highest in customer satisfaction in 2005 by J.D. Power in the major marine climate markets.

## How Quality Houses Perform

You don't want to spend the first several months in your new home fixing construction problems. Not long after unlocking a new home's door for the first time comes the reality of keeping the house and its inhabitants happy and comfortable. You'll save time, money, and personal energy when you buy a house that works from the start. The building materials and quality that go into an energy-efficient home help to keep temperatures even, the air clean, and the house dry, quiet, and draft-free. In a well-designed home, systems are designed to work together for optimal performance. The checklist near the end of this chapter provides details of what to look for in quality home construction. Figure 1 provides an overview of features Building America recommends to help you avoid problems, while saving time, money, and energy.

### FIGURE 1: Marine Climate Design Features

All of these features save energy. Read the descriptions at right to see what else they do.

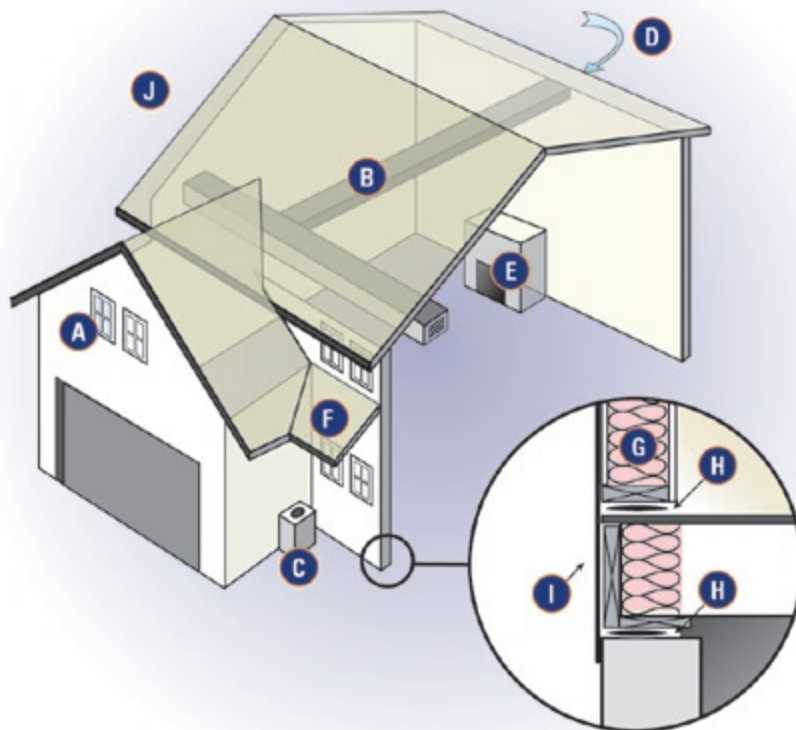

## Marine Design Features

- A. Efficient Windows:** help to control and reduce ultraviolet light that can fade carpets and furniture, helping to keep your belongings looking like new and keeping window areas cooler and more comfortable to sit near. Window flashing protects against water leaks.
- B. Compact and Tightly Sealed Duct Runs:** shorter runs mean less to go wrong and fewer air leaks to put air where it is intended to go, with fewer contaminants like humidity and dust from attics or crawlspaces. Leaky ducts can be a major contributor to mold problems. Return air paths ensure balanced air pressure for less drafts and more balanced temperatures throughout the house. Put ducts in conditioned space, if possible.
- C. Right-Sized and High-Efficiency HVAC Equipment:** costs less to install than bigger equipment, saves energy, and is designed to comfortably handle heating and cooling loads.
- D. Ventilation:** exhaust fans remove moisture and pollutants. A controlled, filtered air intake ensures plenty of fresh air.
- E. Sealed Combustion Appliances:** direct-vented furnaces, boilers, and water heaters ensure the removal of combustion gases. We recommend against non-vented combustion appliances such as non-vented fireplaces or heaters.
- F. Overhangs:** provide shade and direct water away from the house. Overhangs are not required by ENERGY STAR but are a sign of thoughtful design and are important in the moist marine climate.
- G. Insulation:** holds comfortable temperatures in conditioned spaces and helps control noise. For insulation level recommendations visit [www.ornl.gov/sci/roofs+walls/insulation/ins\\_16.html](http://www.ornl.gov/sci/roofs+walls/insulation/ins_16.html) Insulation levels must meet code requirements.
- H. Air Sealing:** stops drafts, helps keep humidity and garage contaminants out of the house, and creates a barrier to rodents and insects.
- I. Well-Designed Moisture Barriers and Drainage:** avoid expensive structural damage and help stop humidity, mold, and mildew.
- J. Building System:** Perhaps the best thing about buying a system-designed house is that all of the parts are designed to work together. This can save you money on the purchase price, and it also means a durable and comfortable system, one that will help avoid maintenance and repair costs down the road.

## An Energy-Efficient Home Will Cost You Less

As with any upgrade, precisely how much is paid for an energy-efficiency upgrade will depend on many factors. Some builders make energy-efficiency features part of their base price, meaning the cost is built into the overall cost of the house. Others will sell you a specific upgrade package at a predetermined cost. Depending on how the builder structures his costs, the home's size and design, and the prevailing cost of building materials, the additional cost of a system-designed energy-efficient home can vary substantially.

The good news is you are likely to pay less for an energy-efficient house on a monthly basis, if you consider the cost of energy. Here's an example showing why:

**FIGURE 2: Monthly Cost Comparison**

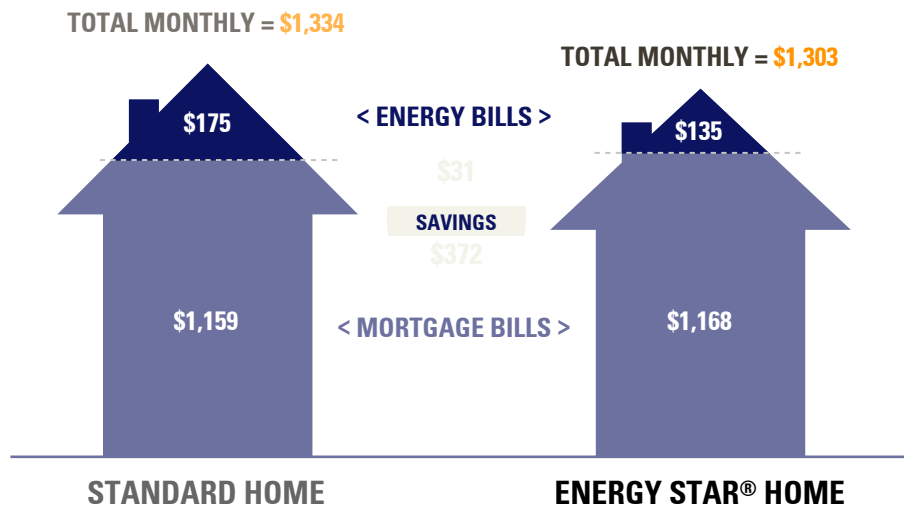

Our example assumes a base price on the house of \$200,000, an upgrade cost of \$1,500, and a 30-year mortgage at 6% interest. We also estimate that monthly energy bills will be about \$135 after energy savings of about \$40 per month in the energy-efficient home.

Your builder or realtor, or a lender offering energy-efficient mortgages should be able to help you work through the savings for your house based on actual features, costs, and interest rates.

## Energy-Efficient Mortgages Can Help You Get More for your Money

Lenders recognize that owning an energy-efficient home makes financial sense and they have developed energy-efficient mortgages to encourage consumers to purchase these types of homes. The loans work by allowing consumers to borrow more than they would typically qualify for.

All major secondary mortgage organizations, including Fannie Mae, the Federal Housing Administration (FHA), the Veterans Administration (VA), and the US Department of Agriculture (USDA) offer energy-efficient mortgages (EEMs), though they use different criteria to determine the level of financing available.

*“You don’t know the quality of life you can experience until you’re in one of these homes. Our quality of life has improved tremendously and we’ll realize energy cost savings for years to come.”*

John Russo, purchased an ENERGY STAR home in 2002, as quoted in the *Boston Herald*, December 6, 2002.

According to the U.S. Environmental Protection Agency, which manages the ENERGY STAR program with the U.S. Department of Energy, **525,000** new homes have now earned the ENERGY STAR designation, saving these homeowners a total of **\$124 million** in energy costs every year.

*“If you can save \$1,000 a year on heating bills – to someone who is making a \$1million a year, this doesn’t mean much. But to someone who is making \$30,000 to \$40,000, this is a big piece of change.”*

Les Bluestone, owner of Blue Sea Development Company in New York

# HOMEOWNERS

## Fannie Mae

Fannie Mae is the nation's largest source of mortgage funding. EEMs are available both for purchase and refinance in conjunction with most Fannie Mae first mortgage products, including conventional fixed-rate and adjustable-rate mortgages. The guidelines of the selected Fannie Mae mortgage apply, with the EEM allowing for the projected energy savings to provide an adjustment to the loan-to-value and qualifying ratios that favor the borrower.

Monthly savings resulting from energy efficiency can be used to qualify borrowers for a larger mortgage, so consumers can buy more home in the form of energy efficiency or other upgrades. To qualify, the home must have been built to EPA's ENERGY STAR Builder Option Package, or you must obtain a Home Energy Rating Systems (HERS) report, which provides a rating of the energy efficiency of the home and estimates the resulting cost savings using average utility rates and usage data. See *What's the Score?* below for more information on HERS. Building America recommends that every home receive this type of rating. You can learn more about Fannie Mae mortgage products at [www.fanniemae.com](http://www.fanniemae.com).

## Veterans Administration (VA)

An EEM may be obtained to make energy efficiency improvements to a home owned and occupied by a veteran, while purchasing a new home, or while refinancing an existing VA loan and including efficiency improvements.

The mortgage may be increased by up to \$3,000 based solely on the documented costs of the energy improvements (personal labor not included), and up to \$6,000 total, provided the increase in the monthly mortgage payment does not exceed the likely reduction in monthly utility costs. It is also possible to receive an EEM of more than \$6,000 subject to a value determination by VA. For more information visit: [www.homeloans.va.gov/veteran.htm](http://www.homeloans.va.gov/veteran.htm).

## Federal Housing Administration (FHA)

Consumers using Federal Housing Administration (FHA) loan insurance should consider FHA's Energy Mortgage Program. This program helps borrowers to include energy-efficiency features in their home by stretching the size of the loan they may qualify for without increasing their down payment. An energy-efficient mortgage is one of many FHA programs that insure mortgage loans. FHA encourages lenders to make mortgage credit available to borrowers who would not otherwise qualify for conventional loans on affordable terms (such as first-time homebuyers) and to residents of disadvantaged neighborhoods (where mortgages may be hard to get). To learn more about FHA programs visit the Web site at [www.hud.gov/offices/hsg/sfh/eem/energy-r.cfm](http://www.hud.gov/offices/hsg/sfh/eem/energy-r.cfm).

## U.S. Department of Agriculture (USDA)

In June 2006, the USDA announced that it would offer special eligibility considerations for low- and moderate-income loan applicants who purchase energy-efficient homes in rural areas. This nationwide pilot program, called *Home Energy Advantage*, will operate for 18 months as part of the USDA's existing *Rural Development Section 502* homeownership loan program.

*"We wanted to prove that you could do it [energy efficiency] with a house of this magnitude. It was a thrill to see just how much energy efficiency was possible."*

Michelle Horstemeyer, the lead builder from John Wieland Homes who teamed with Building America to achieve 50% energy savings on the 6,431-sq. ft., \$1.3 million New American Home in Atlanta, Georgia.

# HOMEOWNERS

Under the program, the qualifying ratios used to determine ability to repay a home loan may be exceeded by up to two percentage points when an energy-efficient home is purchased. Loans can be made for up to 100 percent of the appraised value of the property. Existing homes that are retrofitted to meet energy-efficiency standards are also eligible for consideration. Read more about the Home Energy Advantage Program at: [www.usda.gov/wps/portal/usdahome?contentidonly=true&contentid=2006/06/0191.xml](http://www.usda.gov/wps/portal/usdahome?contentidonly=true&contentid=2006/06/0191.xml).

Some builders are working with lenders to offer special mortgage terms, such as lower interest rates, to help buyers of energy-efficient homes. Ask your builder if they have any special programs.

- ENERGY STAR Qualified New Homes – [www.energystar.com/index.cfm?c=new\\_home.hm\\_index](http://www.energystar.com/index.cfm?c=new_home.hm_index)
- Fannie Mae – [www.fanniemae.com](http://www.fanniemae.com)
- Federal Housing Administration (FHA) – [www.hud.gov/offices/hsg/sfh/eem/energy-r.cfm](http://www.hud.gov/offices/hsg/sfh/eem/energy-r.cfm)
- Residential Energy Services Network (RESNET) – [www.natresnet.org](http://www.natresnet.org)
- US Department of Agriculture (USDA) – [www.rurdev.usda.gov](http://www.rurdev.usda.gov)
- Veterans Administration (VA) – [www.homeloans.va.gov/veteran.htm](http://www.homeloans.va.gov/veteran.htm)

**FIGURE 3: HERS Index**

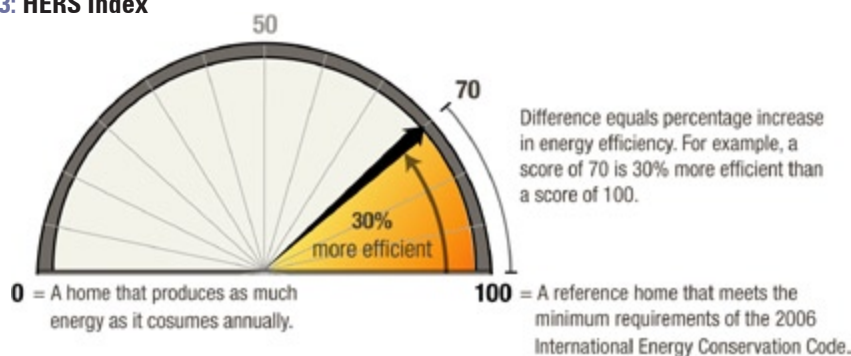

*After July 2006, HERS scores will be reported on an Index from 0 to 100. Zero represents a house that produces as much energy as it consumes annually. 100 represents a reference home that meets the minimum requirements of the 2006 International Energy Conservation Code.*

## What's the Score?

The Home Energy Rating System (HERS) is a nationally recognized method of evaluating a home's energy performance. Rating professionals are people trained in evaluating houses and accredited by the Residential Energy Services Network, found on the Web at [www.natresnet.org](http://www.natresnet.org).

Even if homes are not participating in labeling programs like ENERGY STAR, the HERS Index can be used to gauge energy efficiency. See the *Designers*  section for more information on HERS.

California utilities offer several programs that can help builders meet ENERGY STAR standards. Some programs include financial incentives. Contact your local utility for more information. Links to utilities can be found at [www.fypower.org/about/index.html](http://www.fypower.org/about/index.html). Information on the Northwest ENERGY STAR program for Oregon and Washington can be found at [www.northwestenergystar.com/index.php?cID=125](http://www.northwestenergystar.com/index.php?cID=125).

## Guaranteed Energy Costs and Comfort

Some builders go even further than doing a great job of constructing an energy-efficient home. Some guarantee it. Builders who guarantee their homes are willing to tell buyers how much energy the home should use, and they guarantee these levels will not be exceeded. These guarantees are backed up with payments if limits are exceeded. Builders can work with insulation companies or other partners to offer guarantees or caps on their home's energy costs, or they may develop their own programs. Some cover room comfort by guaranteeing that the temperature at the thermostat will not vary by more than 3 degrees at the center of any room served by that thermostat. A Building America team helped to develop these programs. Information on three of these programs can be found at:

- Environments for Living – [www.eflhome.com/index.jsp](http://www.eflhome.com/index.jsp)
- Engineered for Life – [www.us-gf.com/engineered.asp](http://www.us-gf.com/engineered.asp)
- The Energy Use and Comfort Guarantee – [www.artistichomessw.com/guarantee.htm](http://www.artistichomessw.com/guarantee.htm)

## And There's More – More Green for You and More Green for the Planet

Where else can you find an investment that delivers monthly dividends, makes you more comfortable and your house more durable, comes with its own financing incentives, and may even have guaranteed energy performance? ENERGY STAR homes give you all this, plus they are good for the environment. Just one ENERGY STAR qualified new home can keep 4,500 pounds of greenhouse gases out of our air each year.

Last year, thanks to programs like ENERGY STAR and other energy efficiency measures, Americans cut their energy bills by more than \$7 billion, along with saving enough energy to power 15 million homes. The greenhouse gas emissions saved by these steps was the equivalent of taking 14 million cars off our country's roads. Visit the ENERGY STAR Web site at [www.energystar.gov](http://www.energystar.gov) to learn more about how ENERGY STAR is helping the environment.

## What to Look For

Take the *Homebuyer's Checklist* at the end of this chapter with you when you're shopping for a new home. Ask your builder or salesperson to help you consider each item. For a more detailed checklist, go to *Appendix I*. You may want to ask to see houses under construction to see how some measures are installed. The builder or realtor may have models and displays to help you see other features and ask to see the home's owners manual. Not all builders have owners manuals, but they should. Not all of the measures on the checklist will apply to every home (for example, homes don't typically have more than one kind of heating system). Check the features that are most important to you. We've left some blank spaces at the end of the checklist in *Appendix I* so you can fill in features that you want to remember to check that may or may not be energy related.

Building America helped Veridian Homes of Wisconsin to design a prototype home packed with innovative features and designed as a system. "We actually incorporated all those ideas into every house that we build. That is now our standard," said Jeff Simon, Veridian's executive vice president of operations.

Just one ENERGY STAR qualified new home can keep 4,500 pounds of greenhouse gases out of our air each year.

## If You're Building a Custom Home

A great advantage to building a custom home, or ordering your home before it is built, is that you can work with your builder or designer to get the features you want. Give your builder or designer this *Best Practices Guide*. It contains everything they need to design and build a durable and comfortable energy-efficient home.

## Sources & Additional Information

- J.D. Power and Associates. *J.D. Power and Associates 2004 New Home Customer Satisfaction Study*. West Lake Village, California. 2004.
- Johnston, David. 2000. "Buyer Green." *Professional Builder*, September 2000. [www.housingzone.com](http://www.housingzone.com)
- *Professional Builder*. "Customer Service Standard Setters." September 2003. [www.housingzone.com](http://www.housingzone.com)

## Web Sites Not Included with Published Documents Above

- [www.artistichomessw.com/guarantee.htm](http://www.artistichomessw.com/guarantee.htm)
- [www.buildingamerica.gov](http://www.buildingamerica.gov)
- [www.buildiq.com](http://www.buildiq.com)
- [www.energystar.gov](http://www.energystar.gov)
- [www.housingzone.com/topics/pb/green/survey/buyer.asp#](http://www.housingzone.com/topics/pb/green/survey/buyer.asp#)
- [www.hud.gov/offices/hsg/sfh/eem/energy-r.cfm](http://www.hud.gov/offices/hsg/sfh/eem/energy-r.cfm)
- [www.eere.energy.gov/consumerinfo/energy\\_savers/?appliances.html](http://www.eere.energy.gov/consumerinfo/energy_savers/?appliances.html)
- [www.eflhome.com/index.jsp](http://www.eflhome.com/index.jsp)
- [www.fanniemae.com](http://www.fanniemae.com)
- [www.fypower.org/about/index.html](http://www.fypower.org/about/index.html)
- [www.northwestenergystar.com/index.php?cID=125](http://www.northwestenergystar.com/index.php?cID=125)
- [www.natresnet.org](http://www.natresnet.org)
- [www.ornl.gov/sci/roofs+walls/insulation/ins\\_16.html](http://www.ornl.gov/sci/roofs+walls/insulation/ins_16.html)
- [www.us-gf.com/engineered.asp](http://www.us-gf.com/engineered.asp)

You can learn more about Building America and download additional copies of this document at [www.buildingamerica.gov](http://www.buildingamerica.gov)



# HOMEOWNERS

## Homebuyer's Checklist for the Marine Climate

Use the following checklist to compare house features in different homes you visit. A more detailed checklist is available in Appendix I.

MEASURE	Building America Recommendations	Builder #1	Builder #2	Builder #3
<b>BUILDER SERVICES AND RATINGS</b>				
ENERGY STAR Rated	Yes			
HERS Index	Yes			
Energy Performance Guarantee	Good Idea			
Energy Efficient Mortgage	Good Idea			
Provides Owners Manual	Yes			

If you can answer **yes** to the above questions you will have a good energy performing home. *The HERS Index can be used for comparing homes and to qualify for local programs and ENERGY STAR.*

<b>VENTILATION</b>				
Controlled fresh air provided in the house	Yes			
Quiet exhaust vents in bathrooms	Yes			
Quiet exhaust (not recirculating) vents in the kitchen	Yes			
Supply and return air vents or paths in bedrooms	Yes			
<b>WINDOWS</b>				
Windows flashed to help repel water*	Yes			
ENERGY STAR windows	Yes			
<b>COMBUSTION APPLIANCES</b>				
Combustion appliance exhausts vented to the outside (except ovens)	Yes			
Hardwired carbon monoxide monitors included for every 1000 square feet of living space if combustion appliances or an attached garage are present	Yes			
<b>MORE TO LOOK FOR TO ENHANCE ENERGY EFFICIENCY</b>				
ENERGY STAR qualified light fixtures	Good Idea			
ENERGY STAR qualified refrigerator	Good Idea			
ENERGY STAR qualified dishwasher	Good Idea			
ENERGY STAR qualified clothes washer	Good Idea			

\*Flashing is also important for doors and other openings—and for the roof.



# MANAGERS

*Putting building science to work for your bottom line*

This document tells company leaders how to use proven technologies and a successful marketing program to gain competitive market advantage and improve your company's economic and product performance. A more efficient home can mean a faster return on your investment

## An Invitation to Building Company Managers

We invite you to use the information in this packet to lead your company to increased profits and greater customer satisfaction. Building America is a U.S. Department of Energy (DOE) program that has sponsored building science research on 30,000 homes nationwide. These technologies and the Building America systems approach can set your company apart, giving you a considerable competitive advantage in how you design, build, and sell homes.

*"There are strong environmental and societal reasons for building energy-efficient homes. Strong, sustainable building practices help a builder differentiate themselves in a competitive marketplace, while still keeping focused on the bottom line."*

Jeff Jacobs Project Manager, Centex, Northern California division

## Building America

Building America works with the nation's premier building scientists to conduct research and bring knowledge to builders to help them build better homes. This knowledge has been gained from private/public partnerships involving builders all over the country working with DOE. Many builders have adopted the program's principles and improved the performance of their houses and companies. Over 250 builders and vendors have partnered with Building America, including five of the largest 10 builders in the nation. This best practices guide contains results from this research in a form that your company can immediately build into your homes to increase efficiency, comfort, and durability. Learn more about Building America at [www.buildingamerica.gov](http://www.buildingamerica.gov).

### QUICK TIPS | MANAGERS

- Some of the most successful builders in the industry are working with Building America.
- Applying the Building America process can: cut your production costs, reduce risks, improve your bottom line, help make you a market leader, and turn your customers into lead generators.
- This document gets you and your company started.
- ENERGY STAR® can help you market your new and improved product.

### INTRODUCTION

*Taking action in your community*



### HOMEOWNERS

*Shopping for value, comfort, and quality*



### MANAGERS

*Putting building science to work for your bottom line*



### MARKETERS

*Energy efficiency delivers the value that customers demand*



### SITE PLANNERS & DEVELOPERS

*Properly situated houses pay big dividends*



### DESIGNERS

*Well-crafted designs capture benefits for builders, buyers, and business*



### SITE SUPERVISORS

*Tools to help with project management*



### TRADES

*Professional tips for fast and easy installation*

### CASE STUDIES

*Bringing it all together*



**FIGURE 1: A small sampling of Building America’s 250 partners**

Building America Partner	Ranking among Top 100 Builders
Pulte Homes	2
Centex Corp	4
Beazer Homes USA	6
The Ryland Group	7
K Hovnanian	9
Shea Homes	13
Weyerhaeuser Real Estate Company	16
Habitat for Humanity International	17

Source: *Builder ONLINE*, 2005



## The Business Case for Building Science and Energy Efficiency

Why are all these builders working with Building America? The answer is simple – Working with Building America can enhance your company’s bottom line. The Building America process and systems approach embraces building science, component technology and the system approach for house design and construction. The benefits include:

- Cost savings from making the best materials and equipment choices
- Reduced risks, increased productivity, and fewer callbacks
- Additional profits on energy efficiency and other upgrades
- Competitive advantage in the marketplace
- Customer satisfaction and referrals.

More information on each of these points is presented below. But boosting the bottom line isn’t the only reason builders build quality, efficient homes. Builders tell us it boosts their pride in their craft, increases the morale of their workforce, and gives them a good feeling at the end of the day, knowing they’re doing their part to help the environment.

## Properly Choosing Materials and Equipment

Building science offers many tools to help you pick out the right materials and size them correctly, and to help make sure you are using them to build the right product. Explanations and suggestions on building systems, designs, and trade-offs are in the *Designers*  chapter of this document. The costs of some measures can be more than what you are currently spending. The idea is to use the materials best suited to the job and to size equipment accordingly. Higher prices in one area can be at least partially offset with savings in other areas. Costs for all building materials can vary tremendously in their own right, but your level of experience and design choices have a large bearing. For comparison, some builders find they experience no overall increase in materials costs to offer an energy-efficient package, but others suggest added costs of up to \$1,500 per home. In the *Designers*  chapter, we show one example of costs and savings that resulted in about \$550 in savings for the design used by a Building America partner in the mixed-humid climate. Read on to find out how this investment can add to your bottom line.

*“With California’s energy code, everyone here is already building a good house. With a few simple changes you can build a great house.”*

**Jeff Jacobs**, Project Manager, Centex, Northern California division

*“It’s not hard and it’s not expensive. You just need to make sure it’s done right. The cost is not a big issue. It just takes a little more work. It takes a little more attention. You’ve got to allow the time for testing and inspection.”*

**Santos Alvarez**, Vice-President of Operations, SummerHill Homes

*“Higher energy efficiency has not been difficult to achieve; better windows, higher efficiency furnaces, ENERGY STAR appliances and light fixtures are all available.”*

**Boyd Lucas**, Equity Residential, executive development manager for the Ft Lewis project

*“For us it’s no more difficult to build energy efficiently than our standard construction process. There was a learning curve, but now it’s just part of our normal production process.”*

**Steve Matus**, Champion Silverton’s quality control manager

## Reduced Risks, Increased Productivity, and Fewer Callbacks

These benefits follow closely from selecting and properly using the right materials and equipment. Making a change in your process may take extra time the first few times you try it, but once established, the payoffs can be significant.

One of the great values of using Building America approaches is that they were designed to solve construction problems, such as moisture degradation and mold growth, that plague builders. More than 10,000 mold cases are now pending nationwide, with an increase in cases of more than 300% since 1999 (Insurance Information Institute as reported in Wood and Clift, 2003).

Applying building science reduces the risk of big problems and helps to eliminate the more mundane defects that cost money to fix. If you reduce the time your crews are working on callbacks, you increase the time they can be working on new product.

## From an Economic Standpoint, Everyone Wins

As a manager, watching your profit margins is a full-time job. The structure of your business and emphasis you place on consistency determines how much profit you get from options packages. Some builders choose to incorporate energy efficiency and health and comfort options into their base price; others include them as options with a profit margin similar to other premium add-ons. Whichever approach you use, the experience of other builders suggest that customers place great value on energy efficiency and will pay to get it.

Profit margins vary substantially from company to company. A National Association of Homebuilders report (1999) and *Professional Builder* magazine (2003) suggest a net profit margin of about 10% on overall house construction. This number is consistent with publicly traded homebuilding companies. Six companies' annual financial reports to the Securities Exchange Commission over 2001 and 2002 reported net profit margins ranging from 4.2% to 9.6%. Gross profit margins over this same time period ranged from 7.4% to 19.2%. In comparison, builders report they have gained about a 30% profit margin on efficiency upgrade packages.

In the *Homeowners*  chapter, we offer an example showing how energy-efficient homes end up costing less for consumers on a monthly basis when both the mortgage and energy expenses are taken into account. Consumers can either pocket these lower costs or use them to buy a more expensive home. Any upgrades translate into added profit.

In short, builders can increase their profits at the same time that consumers lower their costs. From an economic standpoint, everybody wins.

## Customer Satisfaction and Referrals

Customer satisfaction matters to your company's future and energy efficiency matters to your customers. Centex and Pulte are two builders dominating J.D. Power 2005 customer satisfaction ratings in 30 markets nationwide. Both builders work with Building America teams. Pulte received the highest ratings in 16 markets and Centex won in 10. Centex won in all three major markets defined by J.D. Power in the Marine

*"The American public has proven over and over that they are willing to pay more for value. The message they need to hear is 'You pay more but you get more.'"*

Jeff Jacobs, Project Manager,  
Centex, Northern California division

*"We decided building energy efficiently was the right thing to do... Every development we build is energy efficient. We typically exceed California's energy code by 18% to 22%."*

Santos Alvarez, Vice-President of  
Operations, SummerHill Homes

*"Building America's technical assistance on building science helped us to reduce callbacks by 70% in our Chicago Division. That's a tremendous savings for our company and means our customers are happier with their homes."*

Frank Beasley, V.P. of Building  
Science, Town and Country Homes

*"There are 4000 units on post, we own them, we pay the utility bill. So energy efficiency is to our benefit."*

Boyd Lucas, Equity Residential,  
executive development manager  
for the Ft Lewis project. In this  
Army development at Ft. Lewis in  
Washington, the developer has long  
term responsibility for utility bills.

# MANAGERS

climate – Seattle/Tacoma, Portland, and the San Francisco Bay Area. Centex was among the highest rated builders in the Ventura County/Los Angeles market. Pulte and Centex are Building America Partners that brand their homes using ENERGY STAR.

J.D. Power found that truly delighted home buyers (those rating their builders a 10 on a 10-point scale) recommend their builder to nearly twice as many people compared to the average new-home buyer (J.D. Power 2005).

## Consumers Expect More

Buyers want energy efficiency and they are willing to pay for it. A 2001 *Professional Builder Magazine* survey found that energy efficiency is the number one upgrade that homebuyers seek in a new home. Nearly 90% of new homebuyers in the survey were willing to spend more for energy efficiency features (Johnston 2001). Consistent with this study, the National Association of Homebuilders (NAHB) found that consumers would be willing to spend up to \$5000 more on a new home if it saved them \$1000 on their annual utility bills (NAHB 2002). And Pulte's customers in Phoenix rated energy efficiency as the most important product-related reason for referring their contractor to new buyers.



*Centex, a Building America partner, was rated highest in customer satisfaction in 2005 by J.D. Power in the major marine climate markets.*

## Competitive Advantage in the Marketplace

One of your key goals as a manager is to gain competitive advantage in the marketplace. The technologies described in this packet can give your company a technological edge. One easy way to tell the public about your new product is to partner with ENERGY STAR. ENERGY STAR is a nationally recognized branding program sponsored by the U.S. Department of Energy and the U.S. Environmental Protection Agency. Consumers trust the ENERGY STAR logo to tell them whether their product is energy efficient. Participating in ENERGY STAR is easy and it gives you an effective way to distinguish your product from your competition's. Over 3,000 builders partner with ENERGY STAR in the United States. And half of the 100 largest builders in the nation have at least one division building ENERGY STAR qualified homes.

ENERGY STAR qualified homes are independently verified to be substantially more energy efficient homes built to 2004 International Energy Conservation code. These savings are consistent with the practices described in this best practices manual. Go to [www.energystar.gov](http://www.energystar.gov) for more information and to see new guidelines for ENERGY STAR qualified homes built in California. Information on Pacific Northwest homes can be found at [www.northwestenergystar.com](http://www.northwestenergystar.com).

The September 2003 issue of *Professional Builder* provides six top reasons why customers are willing to recommend a builder. **Energy efficiency is first among the reasons related to product.**

## *“Nearly 93%*

*of buyers of Pulte Homes in Phoenix had made at least one positive recommendation.”*

*Professional Builder Magazine, September 2003, p. 67*

*“Our attention to energy efficiency is what really makes Pulte's homes stand out.”*



*Les Woody, Pulte Phoenix  
Director of Customer Service*

*“Building America helps us with our reputation within the building community. Our reputation on the street is that if you want a good quality home you go to Pulte.”*

*Alan Kennedy, Vice President of  
Construction for Pulte Tucson*

## Take the Next Step

This information packet is designed to give your company all the information you need to start using the Building America systems approach in the marine climate. The techniques described will help you avoid many of the problems plaguing all builders in the marine climate.

Make sure your team reviews the sections prepared for each of your company's capability areas: marketing, site planning, design, building site supervision, and the trades. This information will help your company compete in an increasingly complex and risky market. Following the design practices discussed in the *Designers*  chapter and the inspection and testing procedures outlined in the *Site Supervisors*  chapter will give you the technical information you need to build your business. Find more information on ENERGY STAR in the *Marketers*  chapter and on the Web at [www.energystar.gov](http://www.energystar.gov).

## Case Studies

Take a look at the case studies at the end of the book. All offer examples of how builders achieve profitable energy efficiency in the marine climate.

## Sources & Additional Information

- *Builder Magazine*. Healthier Profits Special Advertising Section. November 2003
- Builder ONLINE, 2005. *Builder 100 Listing*. [www.builderonline.com](http://www.builderonline.com)
- J.D. Power and Associates. 2005. *2005 New-Home Builder Customer Satisfaction Study*. [www.jdpa.com](http://www.jdpa.com)
- J.D. Power and Associates. *J.D. Power and Associates 2003 New Home Customer Satisfaction Study*. West Lake Village, California. 2003.
- Johnston, David. 2000. "Buyer Green." *Professional Builder*, September 2000. [www.housingzone.com](http://www.housingzone.com)
- National Association of Home Builders. *The Truth About Regulatory Barriers*. Washington, D.C. 1999.
- National Association of Home Builders. 2002. *What 21<sup>st</sup> Century Home Buyers Want*. NAHB, Washington, D.C.
- *Professional Builder*. "Where are the Giants Headed? Industry Consolidation is Changing the Way Even the Smallest Production Builders Do Business, but How Far it Will Go is Still Open to Debate." April 2003. [www.housingzone.com](http://www.housingzone.com)
- *Professional Builder*. "Customer Service Standard Setters." September 2003. [www.housingzone.com](http://www.housingzone.com)
- Wood, C., and L. Clift. "Seven Wonders of the Construction World." *ProSales*. October 2003, pp. 28-44.

## Web Sites Not Included with Published Documents Above

- [www.energystar.gov](http://www.energystar.gov)
- California Energy Commission has a series of brief online videos that describe why energy efficient building makes business sense. You can find and play the videos at [www.energyvideos.com](http://www.energyvideos.com); click on "Beyond the Codes".
- [www.northwestenergystar.com](http://www.northwestenergystar.com)

"You want buyers to be happy about their house 5 or 6 years from now. You want buyers who will say 'I talked to my friends who bought a house from a different builder and they don't have everything I do with this house.'"

Jeff Jacobs, Project Manager,  
Centex, Northern California division

You can learn more about Building America and download additional copies of this document at [www.buildingamerica.gov](http://www.buildingamerica.gov)



# MARKETERS

*Energy Efficiency Delivers the Value that Customers Demand*

By selling homes you bind your company to its customers. Your work enables the company to capitalize on the benefits of its investments, including those made in energy efficiency. And you are the ones who help homeowners understand the quality, value, and economy represented by your product.

## ENERGY STAR® Qualified Homes: Telling Your Story

An easy way to sell energy-efficient homes is to become an ENERGY STAR partner. Even if you build or sell great houses, ENERGY STAR makes it easier for your customers to know how much efficiency they are getting with tools that help you to tell your story. The ENERGY STAR is a recognized logo that signals consumers you are selling a superior product. And the ENERGY STAR program offers much in the way of advice and examples of how to use the logo. Differentiate yourself by offering a home that is certified to be more efficient—and better for the environment—than standard models.

To find out more about marketing with the ENERGY STAR logo visit the program's Web site at [www.energystar.gov](http://www.energystar.gov). You'll find information about before-sales marketing, point-of-sale techniques, and building ongoing relationships with your customers. Much of the information comes from successful techniques used to sell ENERGY STAR homes across the nation. Tools on the Web site will help you instantly craft your message and prepare sales materials.



*ENERGY STAR offers a marketing platform that home builders can use to recognize that you offer truly energy efficient homes.*

### QUICK TIPS | MARKETERS

- Energy efficiency, and the performance that comes with it, gives you a competitive advantage.
- ENERGY STAR can help you capitalize on your competitive advantage, produce marketing materials, and connect with buyers.
- Your customers see energy efficiency as a sign of value.
- Some of the biggest builders in the country have learned that energy efficiency can turn existing customers into new sales leads through customer satisfaction.
- Learn how industry leaders sell new energy-efficient homes.

### INTRODUCTION

*Taking action in your community*



### HOMEOWNERS

*Shopping for value, comfort, and quality*



### MANAGERS

*Putting building science to work for your bottom line*



### MARKETERS

*Energy efficiency delivers the value that customers demand*



### SITE PLANNERS & DEVELOPERS

*Properly situated houses pay big dividends*



### DESIGNERS

*Well-crafted designs capture benefits for builders, buyers, and business*



### SITE SUPERVISORS

*Tools to help with project management*



### TRADES

*Professional tips for fast and easy installation*

### CASE STUDIES

*Bringing it all together*



# MARKETERS

## Increase Customer Satisfaction and Let Your Customers Sell Your Product

Wouldn't it be great if, for every home you sold, you could add a new sales associate to your staff to sell even more?

That's what energy efficiency can do for you. Happy customers will sell your products for you. And energy-efficient homes make happy customers. Compared to standard homes, energy-efficient homes cost less to own, are more comfortable to live in, and require less maintenance.

The builder with the top customer satisfaction rating in the nation in 2003, Pulte Homes of Phoenix, is a Building America partner offering ENERGY STAR qualified homes. Pulte's Phoenix division has had one or more positive referrals from 93% of its homebuyers. The conversion rate for shoppers referred in this way is twice that of non-referred shoppers. Homeowners talk, and word of mouth is a powerful selling tool. Some experts, in fact, say word-of-mouth is the most effective selling tool because



*Centex uses this display developed by ComfortWise to show some of the benefits of energy efficient windows. ComfortWise is a home labeling program created by ConSol, a firm that leads a Building America team.*

it carries with it the credibility of a trusted third party, such as a friend or relative. Add to that the fact that many potential buyers are skeptical of traditional advertising, and it's no surprise that 10% to 30%, and sometimes more, of builders' sales come from referrals (Farnsworth 2003). The best way to sell homes is to let your customers do it for you. See the *Managers* chapter for information on the great customer satisfaction ratings received by builders selling ENERGY STAR homes.

## Sell the Value that Home Buyers Expect

Market research shows:

- J.D. Power found that truly delighted home buyers (those rating their builders a 10 on a 10-point scale) recommend their builder to nearly twice as many people compared to the average new-home buyer (J.D. Power 2005).
- Energy efficiency is the number one upgrade sought by homebuyers of new homes (*Professional Builder Magazine* 2001).
- Nearly 90% of new homebuyers are willing to spend more for energy efficiency (Johnston 2000 and NAHB 2002).
- Buyers rate energy efficiency as a home builder's most important product-related reason for referring new customers (*Professional Builder Magazine* 2003).

## How Industry Leaders Sell Energy-Efficient Homes

The NAHB Research Center sponsors an annual award competition called the Energy Value Housing Award. The Center has compiled the winning builder's

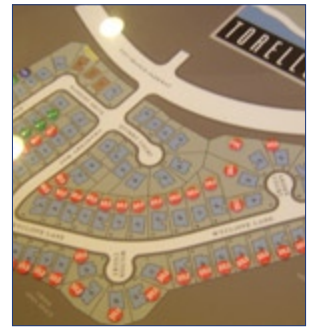

*At Centex's Torello project, houses are nearly sold out and all are rated as ENERGY STAR.*

*"We need to educate the buyer. If you have a builder out there who starts including photovoltaics, or tankless water heaters, or super efficient furnaces and you don't distinguish it, pretty soon you are just giving it away."*

**Jeff Jacobs**, Project Manager,  
Centex, Northern California division



*"The sales associates love it (our energy efficient construction); they look forward to selling it and to telling home owners about it."*

**Santos Alvarez**, Vice-President of  
Operations, SummerHill Homes



# MARKETERS

marketing techniques into a document that can be purchased on the Web at [www.nahbrc.org/tertiaryR.asp?CategoryID=1705&DocumentID=3404](http://www.nahbrc.org/tertiaryR.asp?CategoryID=1705&DocumentID=3404) (Sikora 2002). Here are some of the best practices recommended by the NAHB Research Center and other sources:

- Educate customers and sales professionals. Show buyers how living in an energy-efficient home will benefit them with lower household costs. The ENERGY STAR Web site has an example as does the *Homeowners*  chapter. Vital to customer education is an informed sales staff and team of local sales professionals.
- Walk-throughs and model homes can be invaluable educational tools for both buyers and sales staff. Model homes with display cutaways of energy features such as insulated attics and wall sections help them understand the energy-efficient construction process. Use labels, flags, and banners to create a fun self-explanatory message to give buyers a focus while they drive or walk the development. Recent research suggests just how important model home, models of house features, and other educational tools are to shoppers (Farnsworth 2003).
- Training sessions can be an effective tool for educating sales staff and professionals. Use slides, sample products, and energy bills as aids.
- One way to educate consumers is to emphasize an energy-efficiency upgrade when signing the final papers. One builder has a wall of testimonials, photos, and utility billing history in his waiting room. All prospects are given an opportunity to view this “wall of fame” before the final sale is made. Another builder has the buyer meet with the building site supervisor after the sale is made. This person gives them one more chance to sign up noting, from a builders’ perspective, what a better house they will get (Rashkin 2002).
- Publications are an educational tool that customers and sales professionals can take home. Develop your own brochures or books or give away reprints of magazine articles, ENERGY STAR brochures, or Building America brochures. Don’t overlook vendors and trade associations. They can provide excellent materials, often at no charge. For example, excellent information on window performance is available at the Efficient Windows Collaborative Web site at [www.efficientwindows.org/index.cfm](http://www.efficientwindows.org/index.cfm). Also, give potential buyers a checklist so they can compare the energy saving measures in your homes with those of other builders. A sample is included in the *Homeowners*  chapter.
- Advertising can be used to explain the energy-efficiency advantages and distinguish builders from their competition. The ENERGY STAR Web site has useful information for designing advertising.
- The Internet and compact disk formats are another forum for presenting all of your education and advertising messages. Some marketers suggest that all builders should have a Web site, even if it is simple and offers only limited information. CDs with brochures or slide shows can be given to potential buyers to take home and replay your message.



*Marketing tools for ENERGY STAR Houses can be customized at [www.energystar.gov](http://www.energystar.gov).*



# MARKETERS

- Seek out free publicity. Nothing is more cost effective than sending a news release to local media to announce business news and other company activities. News releases can cover your company's involvement in educational activities, for example, teaching school children about energy efficiency or other charitable actions.
- Offer energy-efficiency guarantees. Energy performance guarantees can help convince buyers that energy savings are real. Partnerships with outside companies can help to establish guarantees. For example, some insulation manufacturers offer home inspections, tests, and cost guarantees.
- Make buyers aware of energy-efficient mortgages.
- Take advantage of the testing data available on your homes. If your company follows the best practices in this guide, you will have blower door and duct tightness test data and a HERS score to share with buyers. Use these data to inform your customers and differentiate your houses. If you can not provide testing, make it available as an option for homebuyer's purchase.

Participate in ENERGY STAR and other partnerships. ENERGY STAR and Building America can provide technical guidance through publications and their Web sites. Partnering with ENERGY STAR cements your company's commitment to energy efficiency and gives you access to the ENERGY STAR brand.

## Sources and Additional Information

- Farnsworth, Christina. 2003. "The Weakest Link." *Builder Magazine*, December 2003. [www.builderonline.com/article-builder.asp?channelid=55&articleid=375&q=consumer+survey](http://www.builderonline.com/article-builder.asp?channelid=55&articleid=375&q=consumer+survey)
- Johnston, David. 2000. "Buyer Green." *Professional Builder*, September 2000. [www.housingzone.com](http://www.housingzone.com)
- *Professional Builder*. "Customer Service Standard Setters." September 2003. [www.housingzone.com](http://www.housingzone.com)
- National Association of Home Builders. 2002. *What 21<sup>st</sup> Century Home Buyers Want*. NAHB, Washington, D.C.
- Rashkin, Sam. 2002. "Surprise! Energy Efficiency Sells without Rebates: Results of Mainstream Builders Selling ENERGY STAR Labeled Homes" *Proceedings of the 2002 ACEEE Summer Study on Energy Efficiency in Buildings*, Washington D.C.
- Sikora, Jeannie. 2002. *Energy Value Housing Award Guide: How to Build and Profit with Energy Efficiency in New Home Construction*. National Association of Home Builders Research Center, Upper Marlboro, MD.

*"Branding, a logo, and good collateral materials help us explain energy efficiency and take credit for the sustainable features that we incorporate in our homes; this really helps the sellers and the consumers understand the products."*

Jeff Jacobs, Project Manager,  
Centex, Northern California division

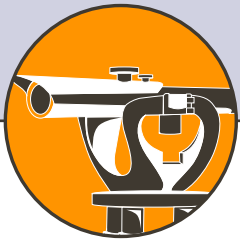

# SITE PLANNERS

*Properly situated homes pay big dividends*

The National Association of Home Builders (NAHB) estimates that 1.6 million new homes will be built each year over the next decade (NAHB 2002a). How these new developments are designed will have a major impact on energy use, the environment, and customer satisfaction.

Developers and site planners can set the stage for efficient communities and can direct builders to protect a community's value through quality building practices.

The sun is the main source of heat in all homes. By looking at how houses receive sunlight, site planners can help optimize how much solar energy is available to heat a house, and minimize the heat that must be removed with air conditioning.

Hotter and dryer portions of the marine climate in the south may be dominated by cooling rather than heating. Avoiding summer cooling is more important than encouraging solar gains for winter heating. Planners should do all they can to avoid the entry of solar energy into houses in summer. Site planners have two important tools to help avoid solar heat gain: **lot orientation** and, in some areas, **shade trees**.

## Lot Orientation

As planners map out lots and roads, the relationship between buildings and the sun should be key. Just as you lay out roads to allow houses to take advantage of great views, or to work around hillsides and other landscape features, also consider how road design, lot lines, and orientation will influence the way that houses face the sun.

Lot lines and roads should be situated to minimize home exposure to east and west. These orientations provide the greatest solar heat gains. Plan your subdivision so that the longer sides of the houses will face north or south. Streets should be positioned in an east-west direction. Proper orientation can result in substantial savings of heating and cooling costs, depending on specific site conditions and house designs. Highly efficient houses, especially when good windows are used, are less dependent on orientation and shading to manage solar gain. With proper planning, there may be no added costs to the builder for good orientation.

### QUICK TIPS | SITE PLANNERS

- Lots facing north or south are preferred to manage heat gain from the sun, so position streets to run east and west.
- Preserve trees for shade and cooler air.
- Take advantage of prevailing breezes from lakes, the ocean, or other geographical features.
- Properly grade your development to take water away from structures.
- Use sustainable site and landscaping practices.

### INTRODUCTION

*Taking action in your community*



### HOMEOWNERS

*Shopping for value, comfort, and quality*



### MANAGERS

*Putting building science to work for your bottom line*



### MARKETERS

*Energy efficiency delivers the value that customers demand*



### SITE PLANNERS & DEVELOPERS

*Properly situated houses pay big dividends*



### DESIGNERS

*Well-crafted designs capture benefits for builders, buyers, and business*



### SITE SUPERVISORS

*Tools to help with project management*



### TRADES

*Professional tips for fast and easy installation*

### CASE STUDIES

*Bringing it all together*



# SITE PLANNERS

Shading is not nearly as important when windows with a low solar heat gain coefficient (i.e., SHGC of 0.35 or less) are used. Using a low-solar-gain low-E coating results in great energy cost reductions for all conditions even with no shading. This is because the glazing itself provides substantial control of solar radiation, so these additional measures become less important in terms of energy use. However, a low SHGC blocks solar heat gain. In places where heat is needed in the winter, solar heat gain can save energy. For a description of the interactions between window performance and shading, see the Efficient Windows Collaborative Web site at: [www.efficientwindows.org](http://www.efficientwindows.org).

**FIGURE 1: Plan subdivision lot lines and roads for predominantly north and south orientation - place houses within lots to take advantage of solar access**

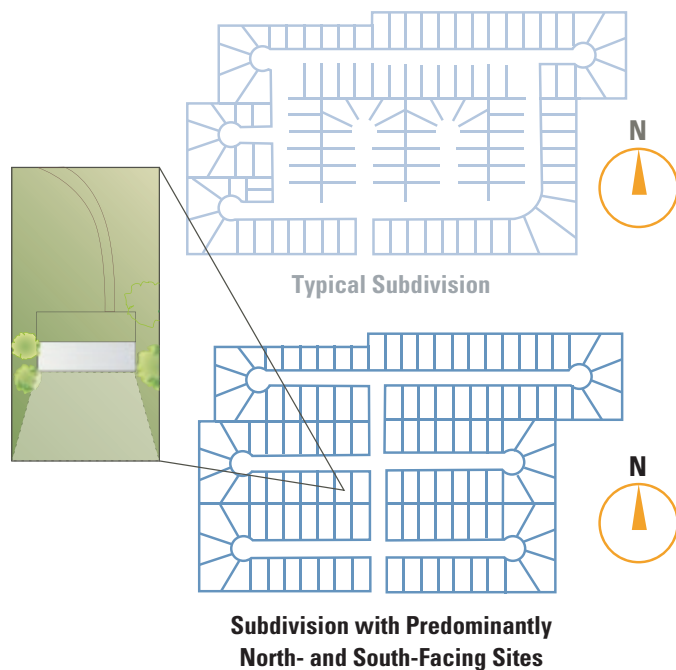

*Adapted from Viera et al. 1992. p.3-5*

Lot orientation is especially important if solar heating or electric generation systems are planned. Inexpensive tools can help assess how much solar energy will be blocked by obstacles on a particular site. Low-cost tools for solar assessments are described in the *Designers*  chapter in the section about windows.

Lot orientation provides access to the sun, but window selection and shading are the controls that manage solar gain. A small Solar Heat Gain Coefficient (SHGC) limits the entry of solar energy. Some Building America teams recommend a SHGC of 0.35. (See the *Designers*  chapter in the section about windows).

In addition to helping manage the sun and providing a marketing advantage, proper street design can reduce the environmental impacts of runoff, encourage walking and bicycling, and discourage speeding by through-traffic.

Subdivision planning can also help to gain cooling benefits from breezes. Houses and other buildings that are tightly packed may create a wake in the wind that is four to five times the buildings' eave height.

## Shade Trees

Tree preservation brings many benefits, one of which is increased salability. Native trees are most beneficial to the environment. The NAHB reports in its survey of buyers, *What 21<sup>st</sup> Century Homes Buyers Want*, that over 80% of respondents in the West rated trees as essential or desirable (2002b, page 61). In 1992, the Florida Solar Energy Center (FSEC) estimated that a treed lot in Florida may increase the value of a home by as much as 20%. American Forests and the NAHB (1995) found that mature trees may add from \$3,000 to \$15,000 to the value of a residential lot.

Trees also bring value by providing shade. It is far better to prevent solar energy from reaching a house than to attempt to manage it once it enters. Shade trees block summer sunlight before it strikes windows, walls, and roofs, dissipating absorbed heat to the air where it can be carried away by the breeze. If photovoltaic or water heating systems will be added, trees must be placed not to shade these systems.

Truly cool neighborhoods have trees. A study in Florida has shown that a subdivision with mature trees had cooler outside air with less wind velocity than a nearby development without trees (Sonne and Viera. 2000). The development with a tree canopy had peak afternoon temperatures during July that were 1.1°F to 3.1°F ( ± 0.7°F) cooler than the site without trees. The total effect of shading, lower summer air temperature, and reduced wind speed can reduce cooling costs by 5% to 10% (McPherson et al. 1994).

Trees are most effective when located to cast shade on the roof, windows, walls, and air conditioners, and when located on the side of the home receiving the most solar exposure. Shade to the southwest and west is especially important for blocking peak solar gain in the summer in late afternoon. Depending on the species, trees more than 35 feet from the structure are probably too far away for shade. Plants too close to air conditioners or heat pumps can plug coils.

**FIGURE 2: Configuration of shade trees**

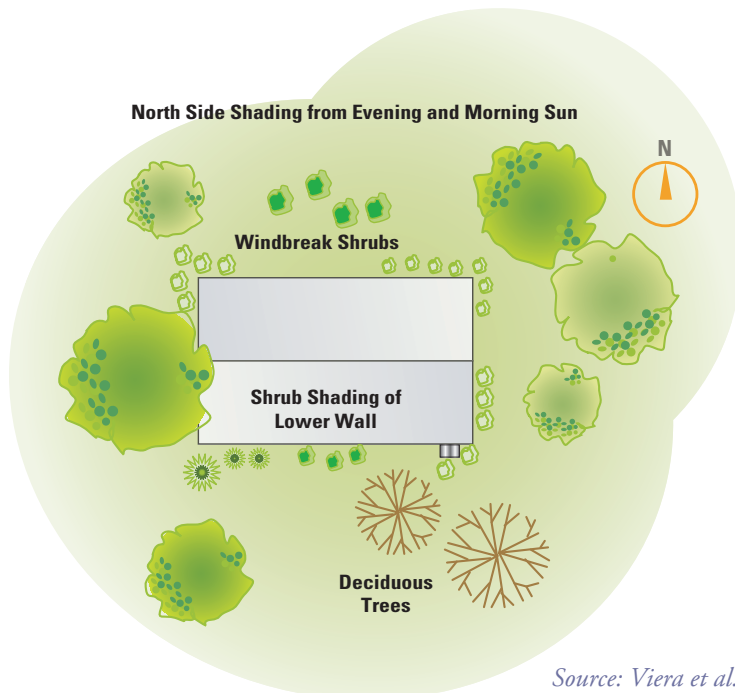

Source: Viera et al. 1992. p.3-8

## Xeriscaping

Rain is not abundant throughout the marine climate, especially in summer. Although fog may hug the coast, inland summer droughts are common. In dry areas xeriscaping may be important. The term is taken from the Greek *xeros*, meaning dry, in combination with landscape.

The goal of a xeriscape is to create a visually attractive landscape that uses plants selected for their water efficiency. Properly maintained, a xeriscape can easily use less than one-half the water of a traditional landscape. Once established, a xeriscape should require less maintenance than turf landscape.

By grouping plants with similar water needs together in specific zones, a xeriscape landscape can use water more efficiently. Low-water-use plants should be grouped together, away from high-water-use plants and turf. Take advantage of warm or cool microclimates (the actual climatic conditions around your property which can be influenced by the placement of walls and shade trees) to create areas of interest and diversity.

A well-planned and well-maintained irrigation system can significantly reduce a traditional landscape's water use. For the most efficient use of water, irrigate turf areas separately from other plantings. Other irrigation zones should be designed so low-water-use plants receive only the water they require. Proper irrigation choices can also save water. Turf lawns are best watered by sprinklers. Trees, shrubs, flowers, and groundcovers can be watered efficiently with low-volume drip emitters, sprayers, and bubblers.

The information presented here was adapted from the City of Albuquerque's Web site at [www.cabq.gov/waterconservation/xeric.html](http://www.cabq.gov/waterconservation/xeric.html). Many jurisdictions in dry landscapes have information, including potential rebates and other incentives.

## Other Steps

In addition to orientation and the use of trees, many other steps can be taken during site planning to make developments user and earth friendly.

## Site Grading

Proper site grading directs surface water away from building foundations and walls. The steeper the slope away from the building, the better the water will drain. Slabs and crawlspaces should always be above the surrounding grade. Basement floors should be higher than the surrounding drainage system. Driveways, garage slabs, patios, stoops, and walkways should all drain away from the structure. See EEBA's *Water Management Guide* (Lstiburek 2003) for more information. Additional information on moisture management is also available in the *Designers*  chapter.

**FIGURE 4: Drain all water away from the structure**

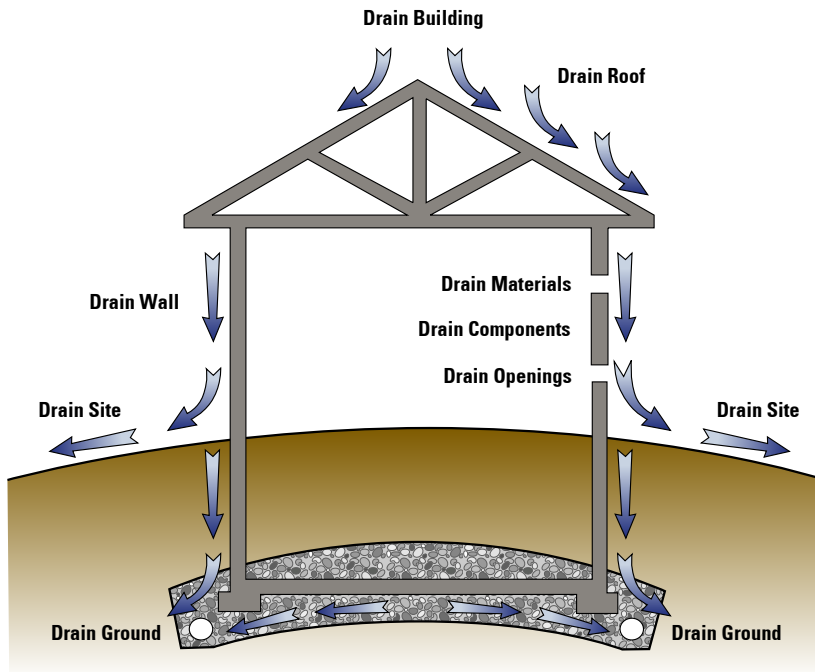

Source: Lstiburek, J.W. 2003. p.4

## Sustainable Development

Builders who choose to advertise their “green” designs have found that buyers are willing to pay for environmental features.

Features that help to conserve the natural environment can include:

- Orienting lots to best manage energy and light from the sun.
- Land planning that preserves the natural environment and minimizes land disturbance.
- Site design that minimizes erosion, paved surfaces, and runoff.
- Preserving and protecting trees and natural vegetation.
- Conserving water indoors and out.
- Designing energy efficiency into houses.
- Selecting materials that are durable and recyclable, or created from recycled products, and considering the energy that goes into making products.
- Recycling construction materials and reducing on-site waste.

Programs with information about sustainable development within the marine climate include:

## CALIFORNIA

- California Green Builder: A homebuilders association program.  
[www.cagreenbuilder.org](http://www.cagreenbuilder.org)

*“What we tell buyers is that we sell value...it’s about high standards in every aspect of home building... The whole idea is to get builders all over the country more concerned about building this way—it’s about energy efficiency, indoor air quality, waste recycling, water recycling, better planning—it all leads to better development.”*

**GW Robinson,**  
President of GW Robinson



*G.W. Robinson pipes recycled irrigation water to cut water use and costs to homeowners at the Cobblefield development in Gainesville, Florida.*

# SITE PLANNERS

- Green Building in Alameda County: A local government program. [www.stopwaste.org/fsbuild.html](http://www.stopwaste.org/fsbuild.html)
- San Francisco Department of Environment, Green Building: A local government program. [www.sfenvironment.org](http://www.sfenvironment.org)
- Innovative Building Review Program Santa Barbara County: A local government program. [www.silcom.com/~sbcplan/ibdrc.html](http://www.silcom.com/~sbcplan/ibdrc.html)

## PACIFIC NORTHWEST

- Earth Advantage®: A non profit organization. [www.earthadvantage.com](http://www.earthadvantage.com)

## OREGON

- G/Rated Green Building Incentive Program: A local government program in Portland. [www.green-rated.org](http://www.green-rated.org)

## WASHINGTON

- Built Green of King and Snohomish Counties: A homebuilders association. [www.builtgreen.net](http://www.builtgreen.net)
- Seattle Sustainable Building: A local government program. [www.cityofseattle.net/sustainablebuilding/](http://www.cityofseattle.net/sustainablebuilding/)
- Built Green Kitsap: A homebuilders association. [www.kitsaphba.com/bbk.html](http://www.kitsaphba.com/bbk.html)
- Built Green of Southwestern Washington: A homebuilders association. [www.builtgreenw.com/index.asp](http://www.builtgreenw.com/index.asp)
- Tacoma-Pierce County Built Green: A homebuilders association. [www.mbapierce.com](http://www.mbapierce.com)

Other places to find more general information about sustainable development are Rocky Mountain Institute's *Green Development: Integrating Ecology and Real Estate* (Wilson, et. al. 1998), the NAHB's *Building Greener: Building Better: The Quiet Revolution* (NAHB 2002c), the Sustainable Building Council's *Green Building Guidelines* (SBIC 2003), [www.lid-stormwater.net](http://www.lid-stormwater.net), a U.S. EPA-sponsored Web site with tools for watershed management, and DOE's Smart Communities Network at [www.sustainable.doe.gov](http://www.sustainable.doe.gov).



*Alameda County developed this builder guide in collaboration with many other local green building programs.*



*National Programs also offer green building tips and ratings.*



## Sources and Additional Information

- Alameda County Waste Management Authority & Source Reduction and Recycling Board. 2005. *New Home Construction Green Building Guidelines*. San Leandro, CA. [www.stopwaste.org](http://www.stopwaste.org)
- American Forests and the National Association of Homebuilders. 1995. *Building Greener Neighborhoods: Trees as Part of the Plan*. NAHB, Washington, D.C.
- Lstiburek, J.W. 2003. *Water Management Guide*. Energy and Environmental Building Association, Minneapolis, Minnesota. [www.eeba.org](http://www.eeba.org)
- McPherson, G.E., D.J. Nowak, and R.A. Rowntree (eds). 1994. *Chicago's Urban Forest Ecosystem: Results of the Chicago Urban Forest Climate Project*. U.S. Department of Agriculture, Forest Service, Northeastern Research Station, [www.f.fed.us/ne/newtown\\_square/publications/technical\\_reports/pdfs/scanned/gtr186a.pdf](http://www.f.fed.us/ne/newtown_square/publications/technical_reports/pdfs/scanned/gtr186a.pdf)
- National Association of Homebuilders. 2002.a *Builder's Guide to the APA's Growing Smart Legislative Guidebook*. NAHB, Washington, D.C.
- National Association of Home Builders. 2002b. *What 21<sup>st</sup> Century Home Buyers Want: A Survey of Customer Preferences*. NAHB, Washington, D.C. [www.BuilderBooks.com](http://www.BuilderBooks.com)
- National Association of Homebuilders. 2002c. *Building Greener: Building Better: The Quiet Revolution*. NAHB, Washington, D.C.
- Sustainable Buildings Industry Council (SBIC). 2003. *Green Building Guidelines: Meeting the Demand for Low-Energy, Resource-Efficient Homes*. U.S. DOE. Washington, D.C. document available at [www.SBICouncil.org](http://www.SBICouncil.org).
- Sonne, J.K. and R.K. Viera, 2000. "Cool Neighborhoods: The Measurement of Small Scale Heat Islands." *Proceedings of the 2000 Summer Study on Energy Efficiency in Buildings*, American Council for an Energy-Efficient Economy, Washington, DC. [www.fsec.ucf.edu/bldg/pubs/pf363/index.htm](http://www.fsec.ucf.edu/bldg/pubs/pf363/index.htm)
- Viera, R.K., K.G. Sheinkopf, and J.K. Sonne. 1992. *Energy-Efficient Florida Home Building*, third printing. Florida Solar Energy Center, FSEC-GP-33-88, Cocoa Beach, Florida.
- Wilson, Alex, Jenifer L. Seal, Lisa A. McManigal, L. Hunter Lovins, Maureen Cureton, William D. Browning. 1998. *Green Development: Integrating Ecology and Real Estate*. Rocky Mountain Institute, Old Snow Mass, CO. [www.rmi.org/sitepages/pid220.php](http://www.rmi.org/sitepages/pid220.php)

## Web Sites Not Included with Published Documents Above

- [www.builtgreen.net](http://www.builtgreen.net)
- [www.builtgreennw.com/index.asp](http://www.builtgreennw.com/index.asp)
- [www.cabq.gov/waterconservation/xeric.html](http://www.cabq.gov/waterconservation/xeric.html)
- [www.cagreenbuilder.org](http://www.cagreenbuilder.org)

# SITE PLANNERS

- [www.cityofseattle.net/sustainablebuilding/](http://www.cityofseattle.net/sustainablebuilding/)
- [www.earthadvantage.com](http://www.earthadvantage.com)
- [www.green-rated.org](http://www.green-rated.org)
- [www.kitsaphba.com/bbk.html](http://www.kitsaphba.com/bbk.html)
- [www.lid-stormwater.net](http://www.lid-stormwater.net)
- [www.mbapierce.com](http://www.mbapierce.com)
- [www.sfenvironment.org](http://www.sfenvironment.org)
- [www.silcom.com/~sbcplan/ibdrc.html](http://www.silcom.com/~sbcplan/ibdrc.html)
- [www.stopwaste.org/fsbuild.html](http://www.stopwaste.org/fsbuild.html)
- [www.sustainable.doe.gov](http://www.sustainable.doe.gov)



# DESIGNERS

*Well-crafted designs capture benefits for builders, buyers, and business*

Even good builders can have bad results if they are working toward the wrong product. Designers have the job of giving builders the opportunity to do the right thing well.

*“If you do the wrong things with good materials and good workmanship, it is still wrong. You must do the right thing with good materials and good workmanship.”*

Joseph Lstiburek, Building Science Corporation

## QUICK TIPS | DESIGNERS

- Building America brings you the results of research, real-world experience, and dialogue with builders from over 30,000 homes nationwide (as of early 2006).
- System design and building science offer you tools and techniques to improve housing performance without sacrificing style and appeal, avoid problems plaguing new homes, find cost savings to help your company’s bottom line, and give consumers satisfaction in their investment.
- Seek the help of a home energy rating professional or engineer to avoid reinventing many of the solutions that have already been found and optimize your designs.
- Review the many technologies discussed in this chapter for help in selecting the applications right for you.

## Building Science and the Systems Approach

Perhaps the most important step in designing any form or function is recognizing that the design is for the entire product. No one piece can be changed without affecting all related pieces. This simple proposition applies to all systems and allows for all kinds of trade-offs. In cars, without any loss in performance, lightweight frames may be translated into smaller brakes, a smaller engine, and smaller tires. Or, that same change may be used to produce more speed.

In houses, this systems approach recognizes the interaction of windows, attics, foundations, mechanical equipment, and all other components and assemblies. Changes in one or a few components can dramatically change how other components perform. Recognizing and taking advantage of this fact, and applying appropriate advances in technology to components, can result in cost and performance payoffs, both for the builder and buyer of new homes.

**Building America has embraced the systems approach and combined it with the technology development and testing that make up building science.**

As with other scientific disciplines, building science provides an intelligent approach to understanding complex systems and diagnosing problems. Over time, knowledge, tools, and tests are developed that make the science and the product more efficient and more powerful (*Adapted from Florida Solar Energy Center Web site [www.fsec.ucf.edu/bldg/science/basics/index.htm](http://www.fsec.ucf.edu/bldg/science/basics/index.htm)*). You can learn more about the U.S. Department of Energy’s (DOE) Building America program at [www.buildingamerica.gov](http://www.buildingamerica.gov).

## INTRODUCTION

*Taking action in your community*



## HOMEOWNERS

*Shopping for value, comfort, and quality*



## MANAGERS

*Putting building science to work for your bottom line*



## MARKETERS

*Energy efficiency delivers the value that customers demand*



## SITE PLANNERS & DEVELOPERS

*Properly situated houses pay big dividends*



## DESIGNERS

*Well-crafted designs capture benefits for builders, buyers, and business*



## SITE SUPERVISORS

*Tools to help with project management*



## TRADES

*Professional tips for fast and easy installation*

## CASE STUDIES

*Bringing it all together*



Four steps can help to manage risks and take advantage of system trade-offs.

- 1) **Give builders the right target.** Recognize you are designing a complete product—a system—and ensure the product is right for the marine climate.
- 2) **Take care of the basics.** The basics are proven, cost-effective technologies that include good windows, insulation, moisture management, and ventilation. Make sure the house has adequate overhangs for shade and rain deflection. Guidelines for many of the basics are included later in this chapter.
- 3) **Take only what you need.** Size heating and cooling equipment, ducts, and fans to match the load. If equipment sizing is normally done by a subcontractor, ensure the sub uses the procedures listed in this document to properly size equipment. Proper sizing of heating and cooling equipment is a huge opportunity to save money and increase profit.
- 4) **Put everything in its place.** Be sure there is a place for everything the house requires and show it on your plans. Do not leave it to chance where ducts will be placed or even where plumbing will run. If there are places that should not be tampered with, for example a duct chase, make it clear the space is off limits to plumbers, electricians, and others who need to create routes through buildings.

## Building Science and the Systems Approach: Prevents Problem

Moisture, mold, and material degradation are examples of problems that building science can help solve. High temperatures create a need for cooling. High humidity adds to discomfort and is a source of moisture. Humid air and a cold surface result in condensation that can add up to discomfort, material failure, and high repair costs.

Leaky ducts located in attics or crawlspaces create air pressure differences that can draw in humid air through cracks and holes and deliver it into the house. Humid air inside a cool space encourages the occupant to turn down the thermostat for more cooling. This cycle can result in moisture forming as condensation on or in ducts, walls, and other assemblies. Accumulated moisture supports mold growth and leads to rotting, warping, and staining.

The result is that a small problem in one assembly (leaky ducts) that is inexpensive to fix during installation, can lead to big problems in framing, interior finish, and human health. Moisture problems may have causes other than leaky ducts, but many unintended problems can be avoided in a similar fashion.

## Building Science and the Systems Approach: Reaps Rewards

There is more than avoiding problems to encourage you to use a systems approach. For example, trade-offs from installing energy-saving measures can help save construction costs for heating and cooling equipment. If good windows, adequate insulation, and efficient heating and cooling equipment are installed, the heating and cooling equipment capacity can also be smaller than typically used and shorter duct runs are possible. All of this can add up to reduced costs in heating and cooling equipment that offset the cost of the other measures. Using trade-offs to improve economics, durability, and comfort is essential to successful business and design.

The challenge to designers is to carefully select new technologies, consider their cost and rewards for your overall system, and use the changes that make sense. Building America has taken this systems approach to designing energy-efficient houses. This document presents you with information that will give you a straight-forward approach to designing houses that qualify for ENERGY STAR®. Design information is provided for a variety of measures and components in the remainder of this section. Put in the recommended measures and your houses should qualify. You may also qualify using other trade-offs. Suggestions from Building America's experience are also included that will improve the health and comfort of your homes.

*“Understand the theory of your construction... then be sure to question your engineer (or subcontractor) as to whether it's all really necessary. If you don't get a straight, understandable answer, find an engineer who will give you one. Remember, it doesn't cost the engineer a penny to over-design. But ultimately someone foots the bill.”*

Tim Garrison, CEO of ConstructionCalc, made an important point about the cost of overdesigning structural components. He is quoted here because his point is equally valid for HVAC and other equipment (*adapted from Nation's Building News Online, 27 April 2004, www.nbnnews.com*).

You can learn more about Building America and download additional copies of this document at [www.buildingamerica.gov](http://www.buildingamerica.gov)

## The Cost of Doing Business

The cost of building homes is different for every builder. Technique, experience, subcontractors, suppliers, and the size of purchases can all make a difference in how much a home costs to build. Even a builder's accounting methods can influence how costs are reported. These variables all apply to energy-efficiency measures and contribute to the difficulty of providing cost estimates that apply to more than a limited example over a short period of time.

In addition to variability, other considerations apply to costs. First, the cost of higher quality housing represents an added value and holds the potential of a higher profit. Second, a tremendous benefit of the systems approach described above is that the costs of energy-efficient measures can often be offset by savings in other areas. And finally, buyers can recover any additional costs through reduced utility bills, increased resale value, and for some, better mortgage terms.

Some builders say that meeting ENERGY STAR qualifications does not increase their costs. However, they must focus on higher quality installations. Other builders suggest additional costs up to \$1,500 to the consumer, but it's unclear if these values apply beyond their experience.

## HERS Ratings and Qualifying for ENERGY STAR

**Best Practice:** Building America recommends working with a Home Energy Rating System (HERS) professional, architect, or engineer early in the design process to help select and size materials and equipment. The building scientists can be especially helpful in right sizing heating and cooling equipment. By forming a relationship with a rater who later will inspect the construction site, designers can get valuable feedback about what works and what house features require more detailed information for the site supervisor and the trades. Find out more about HERS raters at [www.natresnet.org](http://www.natresnet.org).

The best use of a HERS rater involves working with your rater in creating your design. When following this path, the rater analyses your construction plans, in addition to at least one on-site inspection and test of the home. The plan review allows the home energy rater to view technical information such as orientation (if known), shading area, proposed equipment ratings, and insulation levels. The on-site test involves blower door testing. Building America also recommends testing ducts for air leaks. Results of these tests, along with inputs derived from the plan review, are entered into a computer simulation program to generate the HERS score and the home's estimated annual energy costs, including heating, cooling, water heating, and other energy requirements.

A HERS rating is a computer-simulated evaluation of a home's energy efficiency. Using a computer model, either a house design or completed structure is compared to a reference house of the same size and shape as the rated home.

RESNET recently completed a comprehensive overhaul of its rating standards that will take affect in July 2006. At that time, the reference home will meet the minimum requirements of the 2006 International Energy Conservation Code (IECC). More information on the IECC can be found at [www.energycodes.gov](http://www.energycodes.gov).

### HERS RATER

Building America recommends working with a HERS rater or building scientist early in the design process.

## DESIGNERS

The new HERS rating will incorporate all of the energy uses of the home into a whole-building “expanded” home energy rating. The traditional HERS ratings covered space conditioning and water heating only. The overhaul increases the energy uses that are considered by home energy ratings by up to 80% in some southern climates and by about 25% in the some northern climates. The new system also allows energy uses like high-efficiency lighting, refrigerators, dishwashers and ceiling fans to be “rated” along with the heating, cooling and hot water systems of the home.

The new system changes the way that rating results are reported. The new system is based on an Index on a 0 to 100 scale, where 100 represents the energy use of the reference home and 0 represents zero net energy use. Each point below 100 amounts to a one-percent decrease in energy use compared to the reference home. The maximum HERS index permitted to earn an ENERGY STAR rating is an 80 in northern colder climates and an 85 in southern warmer climates. Specific criteria apply to ENERGY STAR qualifications in the marine climate states. For more information on qualifying for ENERGY STAR in California visit [www.energystar.gov](http://www.energystar.gov) and [www.fypower.org/about/index.html](http://www.fypower.org/about/index.html). For information in Oregon and Washington visit [www.northwestenergystar.com](http://www.northwestenergystar.com).

*“We are building a much higher performing home today than we were building three years ago based on what we learned from the first Huntington plan. You can see it in the HERS ratings we receive on our homes...it continues to improve every day.”*

**Jeff Simon**, Executive Vice  
President of Operations for  
Veridian Homes

### California 2006 ENERGY STAR Qualified Homes

All ENERGY STAR Qualified Homes built in California must be 15% more energy efficient than the California energy code (2001 T-24 or 2005 T-24) under which they were permitted. Homes built under 2001 T-24 code have until December 31, 2006 to complete construction. All homes completed on or after January 1, 2007 must be 15% more energy efficient than the latest T-24 code.

Any home formally enrolled in a utility incentive program for ENERGY STAR Qualified Homes by December 31, 2005 until December 31, 2006 to complete construction and be labeled under old guidelines.

All homes enrolled in a 2006 utility ENERGY STAR Qualified Homes (residential new construction) program must be qualified using the new guidelines. The 2006 ENERGY STAR Qualified Homes guidelines requirements include:

- Homes must be 15% more energy efficient than the code under which the home is permitted.
- The EPA ENERGY STAR Thermal Bypass Checklist/CEC Quality Installation Insulation merged protocols are a mandatory requirement.
- Performance credit to achieve 15% over code using quality insulation installation (TBC/QII) is not allowed.
- Ductwork leakage must be less than 6 cfm to outdoors per 100 square feet of conditioned space, though duct leakage tests can be waived if ducts and equipment are located in conditioned space and the home’s envelope leakage is less than 0.25 CFM 50 per square foot of building envelope.
- All cooling equipment shall be sized according to the latest editions of the ACCA Manuals J and S, ASHRAE 2001 Handbook of Fundamentals, or the equivalent computation.

*Source: [www.energystar.gov](http://www.energystar.gov)*

# DESIGNERS

Your HERS rater can be a tremendous resource in the design phase. Raters who are trained in building science may help to solve construction problems. One important job your rater can help with is to work with the mechanical contractor to correctly size heating/cooling equipment, perform room-by-room calculations to determine the supply air needed for each room, and work with the mechanical contractor on duct sizes and lay out. This is likely to eliminate callbacks due to comfort complaints and can save substantial money by right-sizing the heating and cooling equipment. During the design stage, the rater can suggest alternatives to attain desired performance levels in the areas of energy, comfort, durability, and health.

Selecting a HERS rater is much like selecting any other professional services provider, such as an architect, accountant, or engineer. Be sure you are comfortable with the rater's communication skills, experience, training, and references before making a selection.

**Best Practice:** Building America recommends that every house receive a site inspection and diagnostic tests from a HERS rating professional. The information gained from these tests can help to isolate specific problem areas that can be solved with further training, more explicit details, better building materials, or other production changes.

## Marine Climate

The marine climate touches on the hot-dry and cold climate zones. The marine climate has moderate conditions most of the time. But weather conditions similar to those found in neighboring climate zones occasionally prevail. Homes in the marine climate are faced with a lot of moisture, often in the form of fog or rain.

The marine climate covers a narrow band paralleling the west coast from the Canadian border south to the county boundary separating Ventura and Los Angeles counties in California. In some stretches, this band is only one county deep inland from the Pacific Ocean. The Marine Climate was designated in recognition of the mild temperatures and moist conditions found along the coast. However, the marine climate borders on the cold climate in the north, and the hot-dry climate in the south and the more extreme conditions of these neighbors are found in some inland areas.

A marine climate is generally defined as a region that meets all of the following criteria:

- A mean temperature of coldest month between 27°F (-3°C) and 65°F (18°C)
- A warmest month mean of less than 72°F (22°C)
- At least 4 months with mean temperatures more than 50°F (10°C)
- A dry season in summer.

The month with the heaviest precipitation in the cold season has at least three times as much precipitation as the month with the least precipitation in the rest of the year.

Another set of challenges arises from the common use of full basements and crawlspaces. These design features may bring extra living and storage space, but they also bring their own moisture and temperature management challenges.

The recommendations in this Best Practices guide apply to the marine climate region. If you aren't sure that your project is within these climate regions, check *Appendix IV* to see a listing of counties and their climates.

## SITE INSPECTION

Building America recommends that every house receive site inspections and diagnostic tests.

FIGURE 1:



## Design Best Practices for the Marine Climate

Housing types vary greatly throughout the marine climate. Basements and crawlspaces are common in the north. Slabs are used throughout the region. In the face of this diversity, this document does not recommend a single set of measures for achieving the 30% energy savings in space conditioning and water heating. We do recommend following the principles included in these Best Practices and adjusting these practices and your designs to make them work together. We also recommend working with a building scientist such as a Home Energy Rating Professional to help with the transition.

The best practices described in this manual are intended to give builders and designers recommendations resulting from Building America’s work on over 30,000 homes. Building scientists have tried and tested these measures on actual homes in the field. This does not mean that every measure will be for you. However, as builders start aiming for higher performing homes, details become more important. It may not make sense to install the best practice in every instance. Sometimes you can get away with less. But making this decision should involve an evaluation of the risks of not using the best practice, and questioning how the overall house system may be impacted.

## Site – Drainage, Pest Control, and Landscaping

Additional planning information related to overall site development is presented in the *Site Planners*  chapter.

### Drainage

Moving moisture away from a building is critically important to maintaining structural integrity.

**FIGURE 2: Drainage**

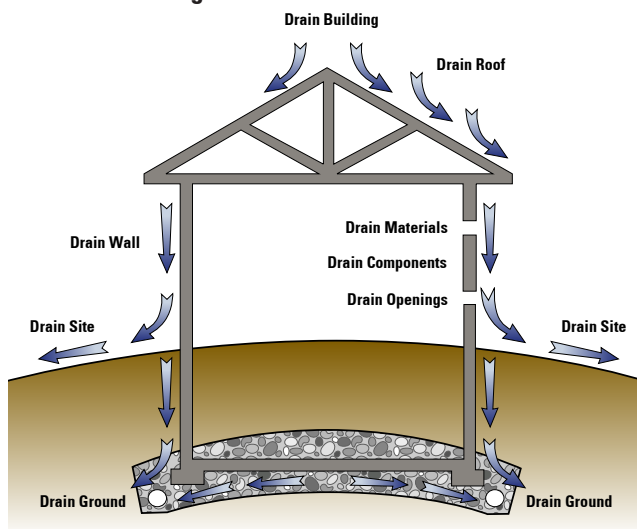

*Adapted from Lstiburek 2003*

**Best Practice:** Grading and landscaping should be planned for movement of building run-off away from the home and its foundation, with roof drainage directed at least 3 feet beyond the building, and a surface grade of at least 5% maintained for at least 10 feet around and away from the entire structure. This topic is also discussed in the *Site Planners*  chapter.

### Pest Control

Termites are a serious menace across the United States.

**Best Practice:** Based on local code and Termite Infestation Probability (TIP) maps, use environmentally appropriate termite treatments, bait systems, and treated building materials for assemblies that are near soil or have ground contact (check with County Cooperative Extension Programs in the area you are building).

*“Now when we do new product development—like introducing new floor plans—we are a lot more particular on roof design and how we are going to manage the water, and this is a direct tribute to Building America. Before if we had a house with a dead valley, we would just field engineer something and build around it. Now, we just don’t accept that from our architects.”*

Vernon McKown,  
Ideal Homes in Oklahoma

### GRADING

Plan grading and landscaping to direct run-off away from the home and its foundation.

### TERMITES

Use environmentally appropriate termite treatments.



## Landscaping

Landscaping is a critical element to the marketability of a house. But plants must be placed to avoid interfering with visual inspections of termite access. Planting can also be used to shade foundations and reduce cooling loads.

**Best Practice:** Plantings should be held back as much as 3 feet and no less than 18 inches from the finished structure, with any supporting irrigation directed away from the finished structure. Plantings may be selected to shade the foundation edge, especially on the southwest corner of the structure. Choosing native plantings results in less irrigation and less chance for irrigation water to create a moisture problem in the house. Decorative ground cover—mulch or pea stone, for example—should be thinned to no more than 2 inches for the first 18 inches from the finished structure. More landscaping information can be found on DOE's Web site at [www.eere.energy.gov/consumer/your\\_home/landscaping/index.cfm/mytopic=11910](http://www.eere.energy.gov/consumer/your_home/landscaping/index.cfm/mytopic=11910).

## Foundation System Moisture and Soil Gas Control

Slabs, crawlspaces, and basements are all found in the marine climate. All building foundations should be designed and constructed to prevent the entry of moisture and other soil gases.

Most foundation water leakage or intrusion is due to either bulk moisture leaks or capillary action. Bulk moisture is the flow of water through holes and cracks. Capillary action occurs when water wicks into the cracks and open spaces of porous building materials, such as masonry block, concrete, or wood. These tiny cracks and pores can absorb water in any direction, even going upward. Moisture can also be carried by soil gas into homes.

Moisture may cause structural decay and can contribute to human health and comfort problems. Radon that enters a home exposes occupants and may cause lung cancer.

The following practices apply to all foundation systems.

- Keep all untreated wood materials away from contact with earth and concrete.
- Design the house structure with overhangs, gutters, drainage planes, and flashing to shed rainwater and conduct it away from the house.
- Slope the earth away from the house and ensure that no irrigation strikes near the foundation as described in the Drainage section.
- Use a sill gasket for air sealing
- Install a protective shield such as metal flashing, plastic L bracket, or a membrane to block capillary water wicking into the wall from the foundation. This material can serve as a termite shield.
- Exterior foundation wall insulation requires a protective coating at above-grade applications. Examples of protective coverings for exterior, above-grade insulation include: flashing, fiber-cement board, parging (stucco type material), treated plywood, or membrane material (EPDM\* flexible roofing).
- Damp-proof all below grade portions of the exterior foundation.
- Place a continuous drainage plane over the damp proofing or exterior insulation on foundation walls to channel water to the foundation drain and relieve hydrostatic pressure. Drainage plane materials include special mats, high-density fiberglass insulation products, and washed gravel. All drainage planes and foundation drains should be protected with a filter fabric to prevent dirt from clogging the drainage channels.

## PLANTINGS

Select indigenous plantings and keep them at least 18 inches from the foundation.

\* EPDM stands for Ethylene Propylene Diene Monomer.

# DESIGNERS

Basements requires a foundation drain installed directly below the drainage plane and beside (not on top of) the footing. Foundation drains are needed for crawlspaces and slabs where the slab or the floor of the crawlspace is located below grade. In combination, these systems should provide a continuous high quality water resistant layer capable of resisting both capillary and hydrostatic water penetration.

## Slabs and Basement Floors

**Best Practice:** Slab foundations and basement floor require 6-mil polyethylene sheeting or rigid foam insulation acceptable for below grade use directly beneath the concrete that accomplishes vapor control and capillary control for the slab. The vapor retarder should continuously wrap the slab as well as the grade beam.

**Best Practice:** A sand layer under the slab or basement floor should never be placed between a vapor retarder and a concrete slab. Cast the concrete directly on top of the vapor barrier. Differential drying and cracking is better handled with a low water-to-concrete ratio and wetted burlap covering during initial curing.

**Best Practice:** Slab and basement floor drainage should include a gravel capillary break directly beneath the slab vapor retarder.

## Crawlspace Foundation Systems

One source of moisture problems in crawlspaces comes from the combination of moist air and cold temperatures. Air in crawlspaces may be moist due to the proximity of soil and air leaks from the house.

**Best Practice:** In crawlspaces, install 6-mil polyethylene across the entire ground surface. Overlay and tape all seams by 12 inches. Seal the polyethylene at least 6 inches up the walls or to a height equal to ground level. Pressure treated wood strapping could be used to fasten the polyethylene to the wall.

Some Building America teams make the following recommendations: install a polyethylene groundcover at the beginning of construction, then install another one on top of the first one when the crawlspace is ready to be sealed up to cover all rips and holes. To improve durability, some Building America teams recommend pouring a minimum 2-inch concrete slab over the polyethylene.

In areas with humid summers, moisture is carried into the crawlspace in the air drawn through traditional wall vents. When this warm moist air reaches cooler structural framing, the moisture can condense out and cause mold and structural problems. In areas with freezing temperatures, cold air may be drawn into the crawlspace and does little to dry out crawlspaces, but can lower temperatures, cause condensation and freeze exposed waterpipes. Although warm-humid or frigid areas are limited in the marine climate, conditioned crawlspaces should be considered for these areas. Conditioned crawlspaces limit condensation by controlling temperatures and moisture entry. A non-vented crawlspace is a more hospitable environment for the air distribution system to operate in. Conditioned crawlspaces are described more fully in the *Structure Thermal Performance* section. Building America is currently conducting research on conditioned crawlspaces in the marine climate. Building America teams recommend using conditioned crawlspaces.

### VAPOR CONTROL

Achieve vapor and capillary control with sheeting or rigid insulation directly below the slab.

### CASTING CONCRETE

Cast the concrete directly on top of the vapor retarder, with no sand in between.

### DRAINAGE

Place a gravel capillary break directly beneath the slab vapor barrier.

### CRAWLSPACE INSULATION

Thoroughly insulate and seal all crawlspaces.

## Radon Control

In addition to other benefits, the gravel and vapor barriers under slabs, basement floors, and crawlspaces are important first steps to radon control. The gravel provides a path for radon and other soil gas to escape to the atmosphere rather than being drawn into the house. And the vapor retarder helps to block soil gas entry into the house. Where gravel is scarce, builders often pour slabs onto sand. When sand or other native fill is used, a 3- or 4-inch perforated and corrugated pipe loop can be use for both drainage and radon control. Or drainage matting may be installed over sand. Both approaches are described in the U.S. Environmental Protection Agency (EPA) documents listed below.

Radon-resistant construction practices are described in the following documents for a variety of foundation systems:

- *ASTM WK2469 New Standard (Formerly E1465-92)(draft) Guide for Radon Control Options for the Design and Construction of New Low-Rise Residential Buildings*
- *Model Standards and Techniques for Control of Radon in New Residential Buildings* (U.S. EPA 1994)
- *Building Radon Out: A Step-by-Step Guide on How to Build Radon-Resistant Homes* (U.S. EPA 2001) available on the Web at [www.epa.gov/radon/images/buildradonout.pdf](http://www.epa.gov/radon/images/buildradonout.pdf).

**FIGURE 3: Typical Building Foundation Systems**

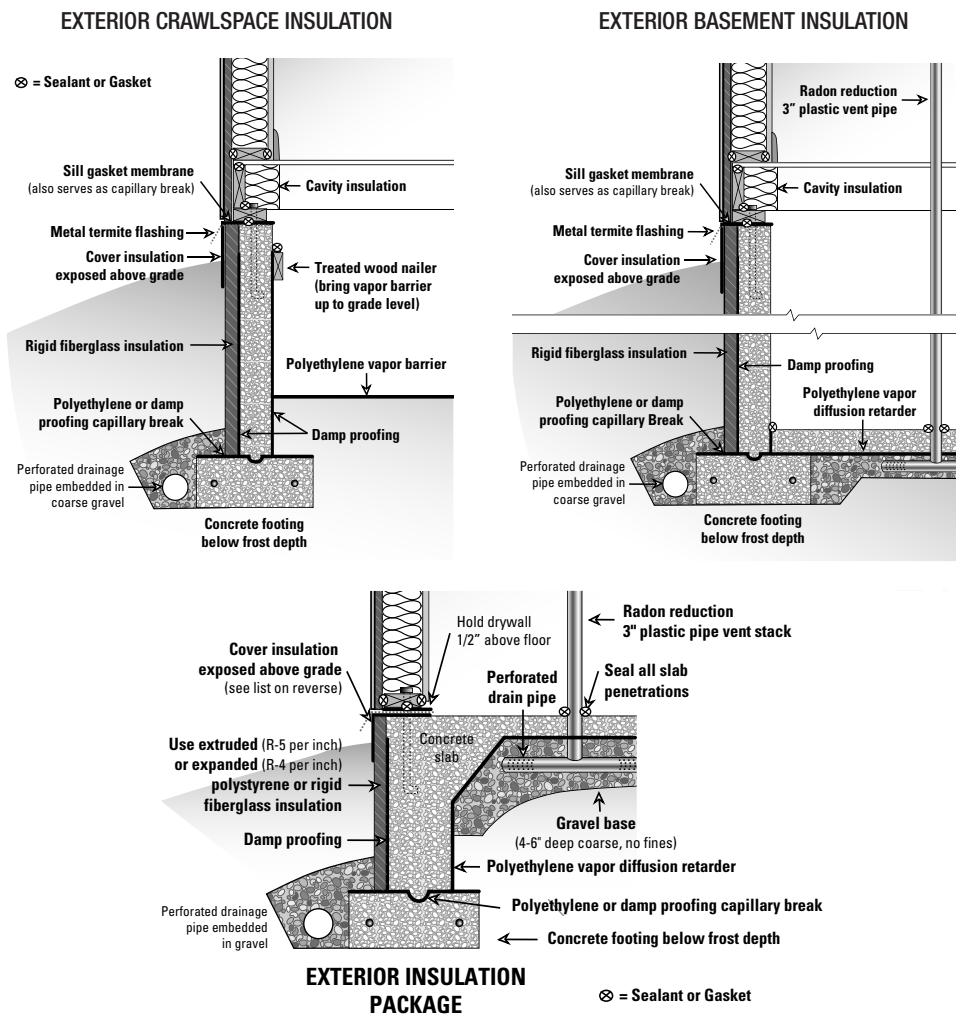

**Best Practice:** Other than identifying areas that have had radon problems, it is not possible to predict radon levels in houses prior to construction, so it is important to include inexpensive radon control measures. One measure recommended by the EPA to control potentially high radon levels and other soil gasses, is a passive soil gas stack connected to a perforated drain pipe embedded in the gravel under the slab, basement floor, or crawlspace ground cover. The stack may also be attached to a perforated pipe loop or mat. If it turns out the house has unacceptable radon levels, a fan can be added to the stack to actively draw soil gas away from the house. To determine potential radon levels in the county in which you are building, visit the EPA's radon potential map at [www.epa.gov/radon/zonemap.html](http://www.epa.gov/radon/zonemap.html).

For information about local variation in radon levels you can find local contacts at the following EPA Web site: [www.epa.gov/iaq/wherelive.html](http://www.epa.gov/iaq/wherelive.html). The EPA divides counties into one of three zones based on radon level potential. The EPA recommends that all homes built in Zone 1 (high radon potential) areas have radon reduction systems.

**Rain falls frequently in the Pacific Northwest.** Sometimes it comes as wind-driven sheets, often a fine drizzle, and sometimes a drenching downpour. The quantity of annual precipitation is less than other regions such as the hot-humid climate and about the same as areas such as the State of New York. But the rain in the Northwest can settle into the landscape and last weeks, and sometimes months, at a time.

**Vancouver, B.C., Seattle, and Portland:** These cities have all faced substantial moisture-related building failures. Researchers from Oak Ridge National Laboratory (ORNL) have concluded that 20% of Seattle multifamily structures built between 1984 and 1998 are suffering premature building enclosure failures due to moisture intrusion (Karagiozis 2002a). ORNL also concluded that in multifamily buildings water penetration is the most critical influence on moisture management of wall systems and water loads become many times greater in walls with windows and joints (Karagiozis 2002b).

## Structural Moisture Control

Moisture is a significant problem in this climate in the form of both high humidity and high rainfall. Most of the marine climate receives more than 40 inches of annual precipitation. Some areas get more than 60 inches. The ambient air has significant levels of moisture most of the year. Since air conditioning is installed in many new homes, cold surfaces are present where condensation can occur. Controlling moisture intrusion and the infiltration of moisture-laden air into building envelopes and keeping moisture away from cold surfaces are major goals of design and construction in the marine climate zone.

Two types of rain management systems have been identified: barriers and screens. Barriers rely on exterior cladding to drain water and are best used with water-resistant building materials, such as masonry block or concrete. Screens have multiple lines of defense against water entry and are used with wood, brick, and gypsum-based materials. Both barriers and screens rely on lapped flashings to direct water to the exterior at critical areas such as seams, windows, and penetrations. In both systems, it is essential that materials are lapped shingle fashion to direct water down and out, away from the wall assembly.

## RADON

Houses built in areas with potentially high radon levels can install a soil gas stack to draw soil gas away from the home.

# DESIGNERS

**Best Practice:** Roof and wall assemblies must contain surfaces that will drain water in a continuous manner over the entire area of the building. Water must have a path that will take it from its point of impact, around any elements such as windows, doors, and seams, all the way to the exterior ground, sloping away from the house.

**Best Practice:** In areas with potentially high winds and heavy rains install four-inch to six-inch “peel and seal” self-adhering water-proofing strips over joints in roof decking before installing the roof underlayment and cover. Increase gutter and rain leader capacity to accommodate heavy rain and large roof areas.

## Water Leakage

One critical point of concern is water leakage around windows. The *EEBA Water Management Guide* offers examples of many window flashing applications. The window flashing examples here are taken from the *Trades*  chapter. These examples are for homes with housewrap and plywood or OSB sheathing.

**Best Practice:** Specify that flashing be installed for all windows and doors. Window and door flashing details should be designed to match specific wall assemblies and claddings.

Flashing systems should be designed in accordance with the ASTM standard entitled *Standard Practice for Installation of Exterior Windows, Doors, and Skylights* (ASTM 2002). In addition to the standard and the EEBA guide, see DOE’s *Technology Fact Sheet on Weather-Resistive Barriers* (DOE 2000), available on the Web at [www.eere.energy.gov/buildings/info/documents/pdfs/28600.pdf](http://www.eere.energy.gov/buildings/info/documents/pdfs/28600.pdf).

## Extreme Weather

The marine climate is vulnerable to high wind and heavy-rain events. Proper structural fastening and impact resistant windows, doors, and skylights are critical to surviving high winds. Proper use of roofing materials can help roofs withstand snow loads and high winds, and protect against severe rains. This document does not provide detailed information on disaster survival but the following sources provide structural details and guidance and a listing of building materials acceptable for high wind areas.

- Federal Emergency Management Agency. *Building a Safe Room Inside Your Home*. [www.fema.gov](http://www.fema.gov)
- Federal Alliance for Safe Homes – FLASH, Inc. Designed primarily for Florida, this Web site contains generally-applicable information about building to resist high winds, wild fires, and floods. *Blueprint for Safety*. [www.blueprintforsafety.org](http://www.blueprintforsafety.org)
- Institute for Business and Home Safety. The IBHS has building guidelines and public information. [www.ibhs.org](http://www.ibhs.org)
- U.S. Department of Energy. A training program for home inspectors to identify hazards. [www.eere.energy.gov/weatherization/hazard\\_workshop.html](http://www.eere.energy.gov/weatherization/hazard_workshop.html)

## VAPOR BARRIERS

Roof and wall assemblies must contain elements that, individually and in combination, permit drying of spaces inside of walls.

## WATER-PROOFING ROOF DECKING

Install water-proofing strips over joints in roof decking.

## WINDOW FLASHING

Flashing should be installed for all windows.

### FIGURE 4: Window Flashing Building Tips

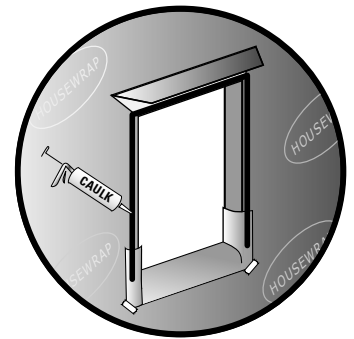

Complete instructions for window flashing are provided in the *Trades* chapter of this handbook.

*“I think the number one issue facing home owners is moisture management. Construction detailing around windows and doors is something that the building industry doesn’t truly understand. You know, no where in the building code do they inspect for flashing.”*

**Vernon McKown**, the co-owner of Ideal Homes in Oklahoma, which builds all its homes using Building America principles.

## The Ins and Outs of Vapor

It's been said that water is lazy, it will always follow the easiest path as it is pulled along by gravity. However, moisture can also cause problems as vapor. Unlike moisture in its liquid form, vapor travels where ever air flows. Air is vapor's heavy lifter. Where there are air leaks, there are vapor leaks.

Diffusion can also force vapor through materials and into places it shouldn't be, such as wall cavities. Differences in vapor pressure and temperature are the forces that drive diffusion. Vapor diffusion moves moisture from areas of higher vapor pressure to areas of lower vapor pressure, and from areas of greater temperature to areas of lesser temperature.

The most important point to make about these two types of vapor transport is that air movement is by far the more important mechanism for moving vapor. Seal up air leaks in the building envelope, both inside and out, and most vapor transport will be blocked from getting inside structural cavities.

The installation of air barriers involves systematically and continuously sealing air leaks. Methods for creating air barriers are described in the section on structural air sealing. Continuous means that the barrier extends over the entire surface of the structure, but the barrier may be made up of many materials. The interior gypsum board may be incorporated into the air barrier, along with studs, draft stopping materials, housewraps, and rigid insulation, as long as the seal is continuous.

Vapor diffusion retarders are materials that block diffusion because they are impermeable. A perm is a unit of measurement based on the amount of water that passes through a material over a fixed period of time. Four classes of permeability have been established. Here are the classes along with examples of materials (adapted from Lstiburek 2004):

- **CLASS 1** - Vapor impermeable (0.1 perm or less): polyethylene film, glass, aluminum foil, sheet metal, foil-faced rigid insulation, and other foil-faced materials.
- **CLASS 2** - Vapor semi-impermeable (1.0 perm or less and greater than 0.1 perm) oil-based paints, most vinyl wall coverings, unfaced extruded polystyrene greater than 1 inch thick, kraft-faced fiberglass insulation, smart vapor retarders.\*
- **CLASS 3** - Vapor semi-permeable (10 perms or less and greater than 1.0 perm): plywood, bitumen impregnated kraft paper, oriented strand board, unfaced expanded polystyrene, unfaced extruded polystyrene (1-inch thick or less), building paper, and one coat of most latex paint.
- Vapor permeable (greater than 10 perms): unpainted gypsum board and plaster, unfaced fiberglass insulation, cellulose insulation, dimensional lumber, and masonry.

*\* Smart vapor retarders are engineered materials that are designed to change their permeance at specific relative humidity levels (BSC 2006)*

*Source: Building Science Corporation (BCS). 2006. Vapor Barriers and Wall Design.*

**FIGURE 5:**  
**Water Carrying Capacity of**  
**Diffusion vs. Air Flow in a**  
**Cold Climate**

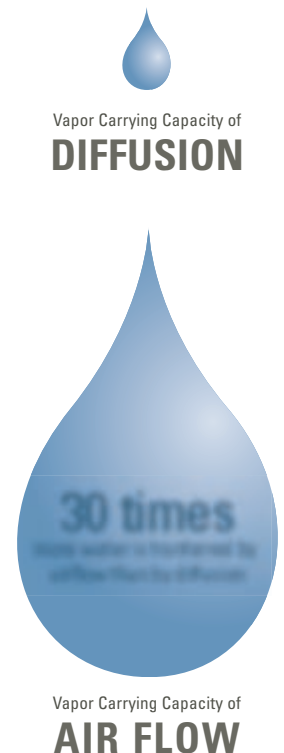

## Vapor Management

Water has many guises and water in its liquid state is not the only problem. Water can also cause problems as vapor. The problem is especially bad when vapor gets trapped within an assembly, such as a wall: turns to its liquid form (condenses); and wets structural assemblies. Condensation can also form in and on ductwork, especially when air conditioning cools duct surfaces that come in contact with humid air, such as in a vented attic or crawlspace.

In the marine climate, and especially in the Pacific Northwest, interior and exterior moisture loads tends to be high. Typically interior relative humidity levels around the nation are maintained at 30 to 40% on average in the winter. Field testing in the Pacific Northwest show that average interior relative humidity in excess of 55% is common in the winter.

Building assemblies need to be protected from getting wet from both the interior and exterior and should be allowed to dry to either the exterior or the interior. Lstiburek (2001) notes three general strategies for managing vapor in wall assemblies:



*Washington State University is using the Natural Exposure Test Facility (NET), established in 2003 to evaluate the effects of heat, moisture, and ventilation on wall assemblies.*

- Installing vapor diffusion retarders on the interior and exterior of wall assemblies to block moisture entry from both directions. This approach is very dangerous if moisture is trapped inside the wall from water leaks, using wet building materials, or vapor transport. Tight construction using OSB (oriented strand board) exterior sheathing and a polystyrene vapor retarder behind the gypsum board may create this situation. Building America teams do not recommend this approach.
- Allowing vapor to “flow through” by using permeable materials on both the interior and exterior sides of the building assemblies. This allows water vapor to diffuse through the assembly from the interior to exterior during heating periods and from the exterior during cooling periods. An example of this type of assembly may include plywood sheathing and vinyl cladding on the exterior and interior gypsum board finished with primer and latex paint.
- Putting the vapor diffusion retarder roughly in the “middle” of the assembly by installing impermeable or semi-permeable insulating sheathing (such as unfaced, rigid, extruded polystyrene foam insulation) on the exterior of a frame cavity wall filled with permeable insulation. This is the system recommended by Building America teams.

Vapor retarders on walls are currently required by building codes, but code changes are anticipated, and engineered wall designs that do not require vapor retarders may be approved by building officials.

Based on research in multifamily buildings in Seattle, ORNL suggests that if interior relative humidity is maintained below 60%, then a latex primer and paint may perform better than the use of a polyethylene sheet (Karagiozis 2002b). Other research suggests that some wall systems with low permeable cladding, such as stucco, may require a class 1 vapor retarder, such as polystyrene sheets, on the interior (Murray 2005). These findings suggest that wall systems are diverse and should be carefully designed to accommodate building materials, local climate conditions, and interior moisture loads.

## DOE Research on Heat and Moisture Transport Properties in Walls

In 2003, DOE sponsored Washington State University and Oak Ridge National Laboratory to build a test bed to evaluate full-scale wood frame wall systems in the Pacific Northwest marine climate. Additional grants and in-kind contributions have come from Certain Teed, Fortifiber, Weyerhaeuser, APA – the Engineered Wood Association, and local suppliers, trade associations, and union apprentice programs.

Key aspects of the research are to explore the interactions of high insulation levels, Washington’s ventilation requirements, and both current and new building practices. The overall impact of successful project completion will be a thorough understanding of building component relationships within a wall system and how they influence hygrothermal performance. With this understanding, building professionals and component manufacturers will be able to scientifically design buildings and products that are directly responsive to natural and conditioned environments. This will provide builders with a higher degree of confidence in the durability of their structures.

One year of research at the NET Facility has shown that stucco clad walls without interior vapor retarders result in moisture accumulation in exterior sheathing. Other findings show the importance of cladding ventilation, the effectiveness of wall systems that couple exterior foam insulation (insulated sheathing) with cavity insulation, and the effectiveness of “smart” vapor retarders that become more permeable as the moisture load increases (the Certainteed MemBrain® was used in the testing and kraft backed insulation share some of these properties) (Murray 2005). Additional research will help provide design guidance over time as additional wall systems and products are tested.

# DESIGNERS

**Best Practice:** Do not install impermeable coverings, such as vinyl wallpaper, on interior walls. Do not install polyethylene vapor retarders on the interior side of wall framing unless the wall system has been carefully designed to use that material. Building codes require polyethylene vapor retarders, but exceptions are available for engineered assemblies. Wall systems can be designed so that primed and painted gypsum board is an adequate vapor retarder.

**Best Practice:** Roof and wall assemblies must contain elements that individually and in combination permit drying of spaces inside the assemblies. Exterior housewraps, including building paper and felt, will allow vapor to pass through and should be installed on the exterior side of sheathing.

**Best Practice:** Water soaking through wood cladding can carry with it contaminants that may interfere with the ability of housewraps, building paper, or felt to resist water. Priming all surfaces of wood cladding avoids water saturation and migration and makes the wood much more durable.

**Best Practice:** Creating an air space between the cladding and the drainage plane effectively increases the durability of both components. With some claddings, such as brick, the air space is especially important. An air space stops capillary movement of moisture, discourages vapor diffusion, stops the contamination of the drainage plane via contact with the cladding, and allows air circulation for better drying. In some wall assemblies, ventilation openings to the exterior at both the top and bottom further encourages drying (Murray 2005). Information on housewrap performance behind brick and stucco can be found at [www.buildingscience.com/resources/walls/brick\\_stucco\\_housewraps.pdf](http://www.buildingscience.com/resources/walls/brick_stucco_housewraps.pdf)

**Best Practice:** Install two layers of building paper or felt in areas prone to severe rain. By providing a double drainage plane, the two layers offer increased resistance to leakage at fasteners, helps solve contamination problems from leaching or contact with stucco, and allows for more flexible installation. In ORNL's study of Seattle multifamily buildings, two layers of 60-minute paper performed better than one layer of No.15 building felt (Karagiozis, 2002b). Two layers may be especially important behind stucco.

**Best Practice:** Installation is key for all types of housewraps. The sheets must be lapped, shingle-style, especially over and around windows, doors, and other penetrations (and their flashing systems). Use manufacturer-specified fasteners and space them according to specifications to provide required support. See the Building Tips on installing housewraps in the Trades  section.

Additional information on moisture control, crawlspace insulation, basement insulation, and slab insulation can be obtained from:

- Lstiburek, Joseph. 2003. *EEBA Water Management Guide* (Lstiburek 2003), available for sale from the EEBA Bookstore, on the Web at [www.eeba.org/bookstore](http://www.eeba.org/bookstore).
- DOE's *Technology Fact Sheets on Weather-Resistive Barriers*, available on the Web at [www.eere.energy.gov/buildings/info/](http://www.eere.energy.gov/buildings/info/)
- Building Science Consortium's Web site at [www.buildingscience.com/designsthatwork/buildingmaterials](http://www.buildingscience.com/designsthatwork/buildingmaterials) where you can compare wraps and other materials.
- [www.buildingscience.com/resources/walls/problems\\_with\\_housewraps.htm](http://www.buildingscience.com/resources/walls/problems_with_housewraps.htm)

## IMPERMEABLE COVERINGS

Impermeable coverings inside the house are not recommended.

## HOUSEWRAPS

Install exterior housewraps.

## BACKPRIMING

Backprime all wood cladding to avoid water saturation.

## AIR SPACE

Creating an air space between the cladding and the drainage plane effectively increases the durability of both components.

## TWO LAYERS OF BUILDING PAPER OR FELT

Consider installing two layers of building paper or felt to create a double drainage plane.

## CAREFUL INSTALLATION

Pay close attention to lapping, especially around windows and doors, as well as the proper use of fasteners.



- The following article provides an overview of house wraps and was a key source for this section: Straube, John. 2001. “Wrapping it Up,” *Canadian Architect*. May, 2001. Available at [www.cdnarchitect.com](http://www.cdnarchitect.com).
- The National Association of Home Builders Research Center’s *Moisture Protection of Wood Sheathing* is available on the Web at [www.nahbr.org/docs/mainnav/moistureandleaks/792\\_moisture.pdf](http://www.nahbr.org/docs/mainnav/moistureandleaks/792_moisture.pdf).
- DOE’s Energy Savers fact sheet titled *Vapor Diffusion Retarders and Air Barriers* available on line at: [www.eere.energy.gov/consumerinfo/factsheets/bd4.html](http://www.eere.energy.gov/consumerinfo/factsheets/bd4.html)
- Lstiburek, Joseph. 2004. *Builders Guides*, available at [www.eeba.org/bookstore](http://www.eeba.org/bookstore). Guides to mixed humid, hot-dry, mixed-dry, and cold climates may apply to the marine climate.

## Housewrap, Building Paper, or Felt – Your Choices for Wrapping it Up

Housewrap, building paper, or impregnated felt should be part of the exterior wall system that protects the building from water penetration. None of the materials are waterproof, but are intended to shed rainwater that penetrates exterior cladding. The surface formed by these materials is called a drainage plane, house membrane, or rain barrier. They are used to shed liquid water that may penetrate siding or roofing and to prevent liquid water from wicking through them, while remaining sufficiently vapor permeable (“breathable”) for outward drying (Straube 2001). By helping to keep building materials dry, these membranes improve building durability, decrease maintenance costs, and reduce the risk of moisture-related problems such as pests, mold, and rot.

**Building Paper** is a Kraft paper sheet impregnated with asphalt to increase its strength and resistance to water penetration. It is primarily employed as a drainage layer. It is graded according to a test of the amount of time required for a water-sensitive chemical to change color when a boat-shaped sample is floated on water. Common grades include 10, 20, 30, and 60 minutes. The larger the number, the more resistant the paper is to water.

**Building Felts** have been in use over a hundred years. Originally made from rags, today’s felts are made of recycled paper products and sawdust. The base felt is impregnated with asphalt. Ratings for felt harken back to the traditional weight of the material before the oil crisis of the 1970s. At that time 100 square feet of the material (1 square) weighed about 15 pounds. Modern #15 felt can weigh from 7.5 to 12.5 pounds per square depending on the manufacturer.

**Housewrap** typically refers to specially designed plastic sheet materials. Housewrap comes in a variety of materials and can be perforated or non-perforated. If joints and connections are sealed, housewraps can serve as air retarders to reduce air leakage. Housewraps are highly resistant to tearing, unlike building paper. Non-perforated wraps tend to have higher liquid water resistance because the holes between plastic fibers are very small.

Most building paper is UV-resistant, whereas recommended housewrap exposure limits may vary by manufacturer. Check with manufacturers if outdoor exposure will exceed a month. One person can usually install building paper, while housewrap requires two people. However, housewrap is available in wide sheets that can cover an entire one-story wall surface in a single pass.

*Adapted from Straube 2001.*

## Structural Air Sealing

**Best Practice:** Use either interior gypsum board, exterior sheathing, or both as a continuous air flow retarder. Exterior stucco may also serve as an air flow retarder. Carefully seal big and little holes. Pay particular attention to sealing shared walls and attic spaces between garages and houses.

**Best Practice:** Use sheet goods, such as hard board, rigid foam insulation, polyethylene sheet plastic, plywood, or sheet metal to seal holes behind tubs, shower stalls, stairs fireplaces, and other potential bypasses.

**FIGURE 6: Envelope Air Sealing**

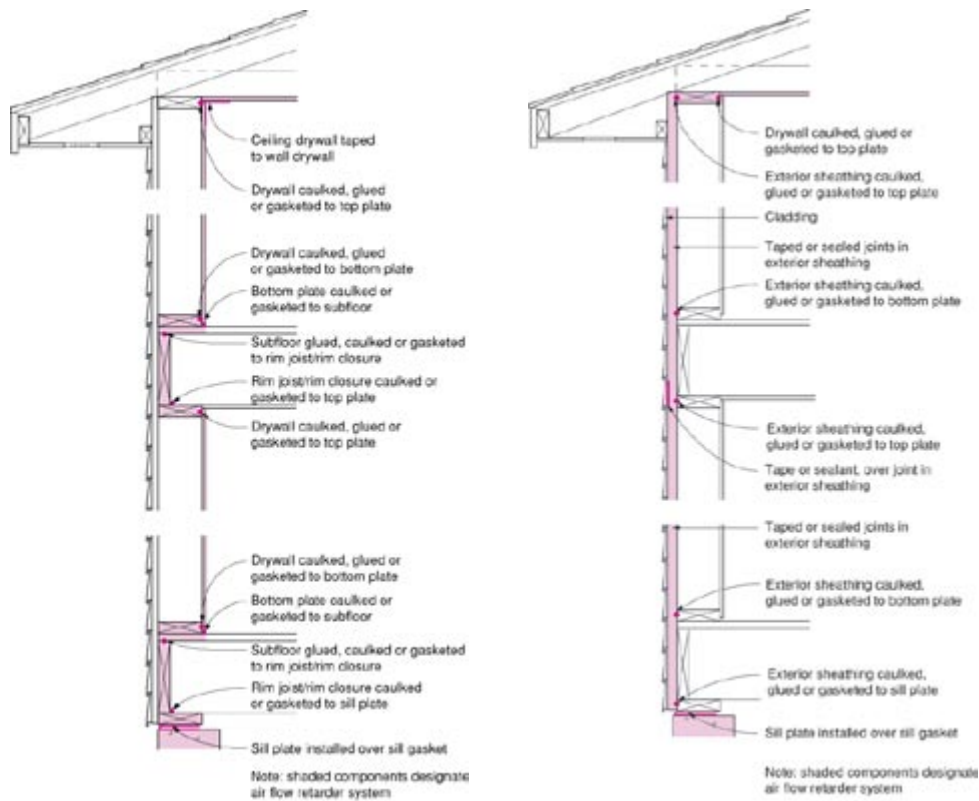

Source: Building Science Corporation

A tight building envelope is necessary to control the movement of air in and out of building assemblies. Air infiltration can contribute to problems with moisture, noise, dust, and the entry of pollutants, insects, and rodents. Using mechanical ventilation as a superior approach to supplying fresh air is discussed in the section on Mechanicals, Electrical, and Plumbing.

Moisture-laden air moving into wall or roof assemblies may lead to condensation and result in deterioration of moisture sensitive materials. Airflow retarders can be installed on the interior or the exterior side of the envelope or on both sides. Insulation made up of batt or loose fill products does not seal against air leakage. Rigid foam board insulation can be used as both a moisture and air retarder.

## AIR SEALING

Be sure to seal shared walls and attic spaces between garages and houses.

## SHEET GOODS

Use sheet goods to seal holes behind all potential bypasses.

## ENERGY STAR THERMAL BYPASS CHECKLIST

The checklist stipulates 16 areas that require special attention to insulation and air barrier continuity.

- 1) Insulation installed in full contact with air barriers for continuous alignment
- 2) Exterior walls behind tubs and showers
- 3) Insulated floors in rooms over garages
- 4) Attic knee walls
- 5) Attic hatch openings and drop-down stairs
- 6) Cantilevered floors
- 7) Duct shafts and piping shafts and penetrations
- 8) Flue shafts
- 9) Attic eave baffles and insulation
- 10) Dropped ceilings and soffits
- 11) Fireplace walls
- 12) Staircase framing on exterior walls
- 13) Recessed lighting
- 14) Porch roofs at intersection with exterior walls
- 15) Whole-house fan penetrations
- 16) Common walls between dwelling units

For more information see the *ENERGY STAR Qualified Homes Thermal Bypass Inspection Checklist* at [www.energystar.gov](http://www.energystar.gov)

# DESIGNERS

Controlling air movement through the building envelope requires sealing both the “big” holes and the “little” holes. The big holes occur behind bathtubs and showers on exterior walls, behind fireplaces, and where soffits or utility walls (double wall with chase) meet exterior walls or ceilings. Recessed lights collectively can be a really big hole in the ceiling assembly. These big holes are responsible for wasted energy (high utility bills) and condensation that can cause mold and wood decay. These holes are easy to seal during the framing stage but only when someone has the responsibility for making sure it gets done. Only airtight recessed lights (ICAT-rated) should be used in ceilings leading to unconditioned spaces.

The little holes occur between framing members (such as band joist to sill plate), around electrical boxes, and where plumbing or wiring penetrate the envelope. All penetrations leading to unconditioned spaces should be sealed with foam or caulk. See the *Trades*  chapter, *Building Tips* on air sealants and the instructions for plumbers, electricians, and framers. Also see the sections later in this chapter for plumbing and electrical.

When air sealing drywall, gypsum board acts as an interior air flow retarder. The gypsum board is sealed to the framing members at the perimeter of exterior walls and around penetrations such as doors, windows, and attic hatches. The gypsum board is also sealed to electrical boxes on exterior walls. Air cannot move through the gypsum board and the taped corners.

There are many approaches and practices to sealing buildings. Many details and photographs of air sealing techniques can be found on the Building Science Corporation Web site at [www.buildingscience.com/designsthatwork/airsealing/default.htm](http://www.buildingscience.com/designsthatwork/airsealing/default.htm), in the EEBA *Builders Guides*, and in the DOE *Technology Fact Sheet on Air Sealing* available on the Web at [www.eere.energy.gov/buildings/info/documents/pdfs/26448.pdf](http://www.eere.energy.gov/buildings/info/documents/pdfs/26448.pdf).

**Best Practice:** One area to pay attention to for sealing is the intersection of the walls and roof. This area may involve an attic, cathedral ceiling, knee walls, all of the above, or other examples of complex roof lines. Figures 7 and 8 show knee wall examples. Tight sealing of this intersection may require blown-in foam. Careful work in these areas will help avoid ice dams.

**Best Practice:** Another area needing special attention for occupant health and safety is sealing shared walls and ceilings between attached garages and living spaces. Carefully seal any penetrations, block air pathways through the attic, and weatherstrip any doors.

## Structural Thermal Performance

Properly installed insulation is like your favorite winter comforter for keeping heat where it’s wanted. Any interior insulation type is acceptable that has vapor permeability. These include cellulose, fiberglass, and foam. Foam can also serve as an air retarder, but air sealing must be accomplished by a separate component or system when cellulose or fiberglass is used.

The following descriptions of insulation were adapted from DOE’s Fact Sheet on Insulation available on the Web at [www.ornl.gov/sci/roofs+walls/insulation/ins\\_08.html](http://www.ornl.gov/sci/roofs+walls/insulation/ins_08.html).

*“Air stoppage is the biggest thing you can do and one of the cheapest.”*

Michelle Horstemeyer, a lead builder for John Wieland Homes

## INTERSECTIONS OF WALLS & ROOF

Tight sealing of the intersection of the roof and wall may require blown-in foam.

### FIGURE 7 & 8: Knee Walls

Figures 7 and 8 show possible approaches to sealing knee walls. Seal knee wall to create a continuous air barrier. Knee walls can be sealed following the wall and attic floor.

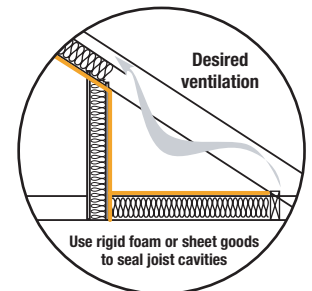

In new homes, it is preferred to seal along the sloping edge of the attic roof.

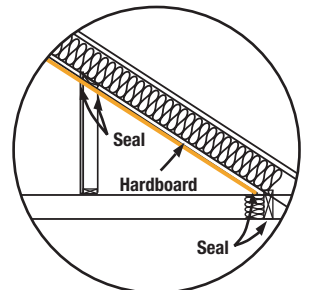

## SHARED WALLS & CEILINGS WITH GARAGES

Pay special attention to the shared walls and ceilings between attached garages and living spaces.

## How Much Insulation Do You Need?

This is an excellent question to ask your Home Energy Rater. The answer depends on your location, the overall design, and the efficiency of other building features. At least the levels required by local code must be installed. Using a systems approach, insulation can be traded off with other building features. The ENERGY STAR Web site contains Builder Option Packages (BOPS) that recommend insulation levels on a county by county basis. The BOPS can be found at [www.energystar.gov](http://www.energystar.gov). Examining the ENERGY STAR BOPs provides some examples of how insulation can be traded off with other features such as efficient windows and HVAC systems. DOE can also help with insulation recommendations for each zip code. Visit the Web site below. Have in hand the first three digits of your zip code and the type of heating system that you are considering. The calculator will recommend an insulation level: [www.ornl.gov/sci/roofs+walls/insulation/ins\\_16.html](http://www.ornl.gov/sci/roofs+walls/insulation/ins_16.html)

If you prefer to work with a map, the following DOE Web site will give you recommended insulation levels:

[www.eere.energy.gov/consumer/your\\_home/insulation\\_airsealing/index.cfm/mytopic=11340](http://www.eere.energy.gov/consumer/your_home/insulation_airsealing/index.cfm/mytopic=11340)

These recommendations are only guidelines and are limited in scope. The more complex or advanced your design, the more you should rely on specific calculations.

## Blankets

Blankets in the form of batts or rolls are flexible products made from mineral fibers, typically fiberglass. They are available in widths suited to standard wall, floor, and attic framing spaces. Continuous rolls can be hand-cut and trimmed to fit. They are available with or without vapor retarder facings. High-density fiberglass batts are about 15% more effective than traditional batts. Even if you choose to use other types of insulation, such as blown or sprayed in cellulose or foam, batts can be installed in areas that may become inaccessible as construction unfolds. These areas could include behind-shower inserts, stairs, or rim joists. Batts also make good dams in attics around access points or other areas where blown-in insulation should be held back.

**Best Practice:** When fiberglass batt insulation is specified, use high-density, unfaced or kraft-faced batts. Batt facing is a vapor retarder and can trap moisture inside walls. Check local code requirements.

## Blown-In

Blown-in, loose-fill insulation includes loose fibers or fiber pellets that are blown into building cavities or attics using special pneumatic equipment. Another form includes fibers that are co-sprayed with moisture or an adhesive that allows them to set in walls and makes them resistant to settling. The blown-in material can provide some resistance to air infiltration if the insulation is sufficiently dense.

## Foamed-In-Place

Foamed-in-place foam insulations can be applied by a professional applicator using special equipment to meter, mix, and spray into cavities. Foam makes an excellent air seal and can be used to reach hard-to-get-at places.

## Rigid Insulation

Rigid insulation is made from fibrous materials or plastic foams that is pressed or extruded into sheets and molded pipe-coverings. These provide thermal and acoustical

## INSULATION

Use high-density batts, when fiberglass batt insulation is specified.

**FIGURE 9: Insulation**



*Blown-in wall insulation*

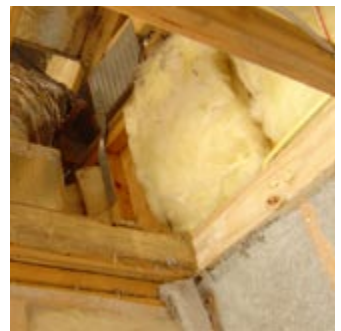

*Batt insulation*

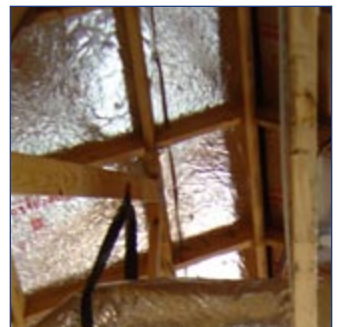

*Reflective insulation*



*Spray-in foam insulation. Soy-based foams are now available  
(Photo: Building Science Corporation)*

insulation, strength with low weight, and coverage with few heat loss paths. Such boards may be faced with a reflective foil that reduces heat flow when next to an air space. Foil facing also makes the board nearly impervious to water and vapor and so should be used with caution. Rigid foam insulation may be used in combination with other insulation types, such as on the exterior of walls that are filled with cellulose or fiberglass. Foam sheets that may be in contact with the ground should be borate-treated for termite resistance (see Figure 11 on page 23 for an example of rigid foam insulation). Rigid insulation may also be applied to the interior and exterior of foundation walls.

## Reflective Insulation Systems

Reflective insulation systems are fabricated from aluminum foils with a variety of backings such as roof sheathing, craft paper, plastic film, polyethylene bubbles, or cardboard. These systems are applicable for sunny portions of the marine climate dominated by cooling rather than heating. If a single reflective surface is used alone and faces an open space, such as an attic, it is called a radiant barrier.

## Slab Foundation Insulation

Slabs in the marine climate may be insulated at the perimeter with borate-treated foam board or rigid glass fiber insulation. Use only insulation approved for below-grade use. Some code officials may require a gap between exterior insulation and wood foundations elements to provide a termite inspection area. Exterior insulation should be applied from the top of the foundation wall to the bottom of the frost line. Cover the exterior face of the insulation exposed to outside air using material such as flashing, fiber cement board, parging (stucco type material), treated plywood, or membrane material.

A shallow, frost protected slab foundation may be used in areas subject to seasonal ground freezing. With this approach, foundation footings need not be placed below frost depth. However, rigid insulation, approved for below-grade use, must be placed vertically on the exterior of the grade beam, and must be placed to extend away from the foundation horizontally at the base of the grade beam for a distance equivalent to frost depth. Rigid insulation is also needed vertically on the inside of the grade beam, and must extend horizontally under the slab, on top of the gravel capillary break, for two feet. Code officials may require that a structural engineer review and approve specific plans.

For more information on shallow foundations see:

- *Houses that Work* (BSC 2004), [www.bsc.com](http://www.bsc.com)
- The American Society of Civil Engineers standard (number 32-01), *Design and Construction of Frost-Protected Shallow Foundations*.
- University of Minnesota, Building Foundations Research Program, *Frost Protected Shallow Foundations Design Specifications*. [www.buildingfoundation.umn.edu/MHFfrostFoundation.htm](http://www.buildingfoundation.umn.edu/MHFfrostFoundation.htm)

Slab perimeters may be insulated on the interior side. This approach requires that rigid insulation be placed between the slab and the foundation wall, and under the slab, as required by local code.

*“It proved to me that some of these measures are worth the extra money, for example, a radiant barrier roof shielding—it helps deflect the heat of the sun, and this helps with the heating bills in the summer time.”*

Michelle Horstemeyer, a lead builder for John Wieland Homes' first Building America home the 2002 New American Home in Atlanta.

## Crawlspace Insulation

Crawlspaces are a foundation method used in the marine climate. Two methods are in use for insulating crawlspaces. The first, in common use over the last several decades, is to insulate the underside of the building floor, and provide outside air vents in foundation walls. Research has shown that this approach can lead to moisture problems, especially in areas with frigid air or warm humid air. These conditions are not common in the marine climate. Ventilated crawlspaces require properly installed floor insulation (see *Building Tips* on Insulation Installation), tightly sealed ducts, and duct insulation. Duct sealing and insulation are described later in this chapter.

Another approach is referred to as conditioned crawlspaces, or mechanically vented crawlspaces. Within this type of system, foundation side walls are insulated on either the interior or exterior (or both), and no outside air vents tunnel through the foundation wall. These conditioned crawlspaces allow for the placement of ducts and air handlers in conditioned space. Research on this type of crawl space system is just getting underway in the Pacific Northwest. Conditioned crawlspaces may require a code variance. Guidance for code officials can be found in *Appendix III, Code Notes*. Building America teams recommend using conditioned crawlspaces.

**Best Practice:** All crawlspaces require proper site engineering and landscaping to maintain adequate site drainage. Local groundwater tables at their maximum elevation should be below the lowest excavated site foundations levels. Sealed crawlspaces have less air exchange with the outside and so behave in a way similar to basements when inundated from improper site drainage or groundwater. For more information see the section on *Foundation System Moisture and Soil Gas Control* earlier in this chapter.

**Best Practice:** The preferred approach is to install insulation on the exterior foundation wall. Exterior insulation will help to protect the foundation from the freeze-thaw cycle and a warmer wall is less likely to condense moisture. Products such as borate-treated foam board or rigid glass fiber insulation work well. Extruded polystyrene (R-5 per inch) is durable and moisture resistant. Expanded polystyrene (R-4 per inch) is less expensive, but it has a lower insulating value. Rigid fiber glass insulation does not insulate as well as foam but provides a drainage plane. Some code officials may require a gap between exterior insulation and wood foundations elements to provide a termite inspection area. Insulation that is exposed above grade must be covered with a protective coating such as flashing, fiber cement board, parging (stucco type material), treated plywood, or membrane material.

If placed on the interior, wall insulation must extend down the wall to a depth at least 2 feet below grade level and be rated for crawlspace and basement exposure. Polyisocyanurate insulation with an aluminum facing is a good interior insulation choice. If the crawlspace wall extends less than 2 feet below grade level, then the remaining insulation must be placed horizontally along the ground at the base of the wall. A sealed ground cover is installed over the entire area of the crawlspace. Install a system to provide conditioned air to the crawlspace. More information is available at:

- Building Energy Codes Resource Center, *Details for Mechanically Vented Crawlspaces - Code Notes*, [www.energycodes.gov/support/code\\_notes.stm](http://www.energycodes.gov/support/code_notes.stm) (includes information on sizing the mechanical ventilation).
- University of Minnesota, Building Foundations Research Program. *Minnesota Energy Code Building Foundation Rule: Amendment Proposal Development Project Final Report*, [www.buildingfoundation.umn.edu/FinalReportWWW/Section-A/A-recs-main.htm](http://www.buildingfoundation.umn.edu/FinalReportWWW/Section-A/A-recs-main.htm)

## CONDITIONED CRAWLSPACES

Insulate foundation side walls on either the interior or exterior (or both).

**Fig 10. Conditioning Crawlspaces**  
(AHU: Air Handling Unit)

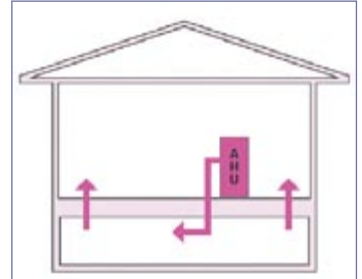

**A: Supply air to crawlspace**

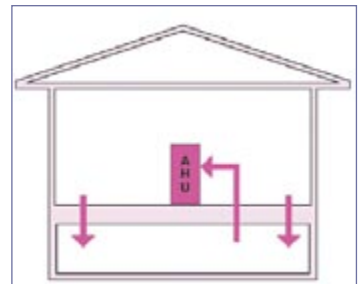

**B: Return air from crawlspace**

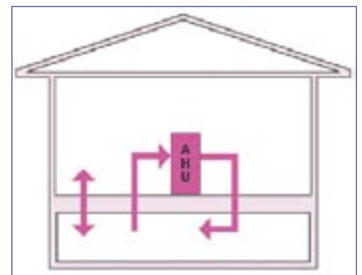

**C: Supply and return to crawlspace**

For all configurations above:

- Minimum 2-4"x8" transfer grilles from house
- 20 cfm of flow per 1,000ft<sup>2</sup> of crawlspace
- Air handler cycled at 5 minutes per hour

Source: Building Science Consortium

## EXTERIOR INSULATION

Install insulation on the exterior foundation wall to help protect the foundation from the freeze-thaw cycle.

# DESIGNERS

- [www.crawlspaces.org](http://www.crawlspaces.org) This Web site is geared toward research done on crawlspaces in the mixed-humid climate.

See these documents from Building America Consortia available at [www.buildingamerica.com](http://www.buildingamerica.com) in the Publications section.

- Broniek, John. *Builder System Performance Packages Technical Report*. Prepared by IBACOS for the Building America Program.
- Yost, Nathan. May 2003. “The Case for Conditioned, Unvented Crawlspaces.” *Building Safety Journal*.
- IBACOS. 2002. *Best Practices: Consider the Crawlspace*.

## Basement Insulation

Basements are a common foundation system in the marine climate. Wall insulation in basements is similar to the approaches described for crawlspaces. And basement floors are insulated in ways similar to slabs.

**Best Practice:** Exterior wall insulation is preferred over interior approaches (Broniek 2003; Yost and Lstiburek 2002). Exterior insulation will help to protect the basement wall from freeze-thaw cycles and will help make the wall warmer, giving condensation less chance of forming and improving thermal comfort. Exterior insulation’s position outside of damp proofing makes it less likely to contribute to problems of trapped moisture inside basement walls. Exterior wall insulation must be approved for below-grade use. Products such as borate-treated foam board or rigid glass-fiber insulation work well. Extruded polystyrene (R-5 per inch) is durable and moisture resistant. Expanded polystyrene (R-4 per inch) is less expensive, but it has a lower insulating value. Rigid fiber-glass insulation does not insulate as well as foam but it is the only insulation option that provides a drainage plane for foundation walls. Some code officials may require a gap between exterior insulation and wood foundations elements to provide a termite inspection area. Insulation that is exposed above grade must be covered with a protective coating such as flashing, fiber cement board, parging (stucco type material), treated plywood, or membrane material. Exterior insulation is an especially good choice in areas with high water tables or poor draining soils.

If interior insulation is used it is important to consider moisture control, insulation flame spread rating, and moisture compatibility. Yost and Lstiburek (2002) discuss three requirements for interior basement insulation systems.

- It must dry to the interior if wetting occurs because the below-grade portion of the wall cannot dry to the exterior. This requirement means that interior polyethylene vapor barriers or any impermeable interior wall finishes such as vinyl wall coverings or oil/alkyd/epoxy paint systems should not be installed.
- The wall system must be tightly sealed to keep interior air from reaching the cool foundation wall. The system must have either an effective interior air barrier (see the section on structural air sealing), or rigid insulation could be installed directly on the interior concrete or masonry surfaces.
- Material is contact with the foundation wall and the concrete slab must be moisture tolerant. A capillary break must be placed between materials that transport moisture and moisture sensitive materials.

## EXTERIOR BASEMENT INSULATION

Install insulation on the exterior foundation wall to help protect the foundation from the freeze-thaw cycle.

Yost and Lstiburek go on to present three strategies for interior basement insulation. The first system uses foil-faced polyisocyanurate rigid insulation attached directly to the upper portion of the basement wall. Extruded or expanded polystyrene can be attached to the below-grade portion of the wall. The polystyrene would require a gypsum board or equivalent covering. Extending gypsum board up the entire wall, leaving at least a half-inch gap at the floor to avoid wetting, provides a finished wall.

A second system has either expanded or extruded polystyrene foam board attached to the entire foundation wall. Extruded polystyrene is more moisture tolerant and should be used if there are any doubts in the external drainage system. Additional insulation can be added to a frame wall built on the interior of the foam insulation. If no additional insulation is desired, wood furring strips can be attached over the foam and gypsum board attached to the furring strips. A similar approach is described in the masonry wall section of this report, suggests the installation of 2x4 furring, against the basement wall, at the intersection with the ceiling, if a firestop is required. Check with local code officials about required fire ratings and stops. Gypsum board should be held at least a half inch above the basement floor to avoid wetting.

A third approach uses pre-cast concrete foundation walls that come with a minimum of 1 inch of rigid foam insulation attached to the interior.

Broniek suggests that a blanket insulation with a perforated facing (to allow drying of the wall to the inside) can also be used on the inside face, but it is best used in combination with exterior insulation and in conditioned basements.

For more information on basement insulation see the following:

- Broniek, John. 2003. *Builder System Performance Packages Technical Report*. Prepared by IBACOS for the Building America Program. Available at [www.buildingamerica.gov](http://www.buildingamerica.gov) in the publications section.
- Yost, Nathan, and Joseph Lstiburek. 2002. *Basement Insulation Systems*. Prepared by the Building Science Consortia for the Building America Program. Available at [www.buildingamerica.gov](http://www.buildingamerica.gov) in the publication section.
- DOE, Office of Building Technology. 2002. *Technology Fact Sheet: Basement Insulation*. Available at [www.buildingamerica.com](http://www.buildingamerica.com) in the publication section.
- IBACOS. 2002. *Don't Forget About the Basement*. Prepared by IBACOS for the Building America Program. Available at [www.buildingamerica.gov](http://www.buildingamerica.gov) in the publications section.

## Frame Walls

**Best Practice:** Best practice for frame wall construction involves advanced framing techniques. However, these techniques are not required to achieve 30% space conditioning energy savings in the marine climate. If you want to gain greater efficiency, more information on advanced framing can be found in the guidance provided in this document for code officials, in the *EEBA Builders Guides*, in DOE's *Fact Sheet on Wall Insulation*, and on the Web at [www.buildingscience.com/designsthatwork/advancedframing/default.htm](http://www.buildingscience.com/designsthatwork/advancedframing/default.htm). If advanced framing is to be used, a detailed plan should be developed showing framing placement.

### ADVANCED FRAMING

Consider advanced framing techniques when constructing walls.



# DESIGNERS

Building America sponsored work by the Building Science Consortium and the U.S. Army Construction Engineering Research Laboratory to develop an inset shear panel for advanced framing in seismic regions. Information on the inset shear panel is available at [www.buildingscience.com/resources/walls/default.htm](http://www.buildingscience.com/resources/walls/default.htm).

External walls with 2x6 framing are typical in the marine climate. These walls should include the following features:

- Exterior sheathing, preferably foam insulating sheathing with joints taped to provide a water and air barrier. Use insulating sheathing that does not have a film facing.
- Insulation may be R-19 friction-fit, kraft-faced fiberglass insulation or blown-in cellulose insulation.
- Frame walls between the garage and the conditioned space, including bonus rooms, should have unfaced or kraft-faced insulation.
- Rim joists: kraft-faced R-19 friction-fit batt insulation cut to fit.
- Penetrations: Foam seal or caulk all top-plate penetrations and exterior wall penetrations.
- In addition to sealing all penetrations, air leakage through the walls should be controlled by sealing the gypsum board. Pay particular attention to air-sealing penetrations to garages and porches.

## Masonry Walls

Masonry walls may be finished with stucco, wood, or other claddings.

**Best practices** to improve thermal efficiency include the following:

- Semi-vapor permeable rigid insulation should be installed on the interior of wall assemblies and should be unfaced. Foil facing and polypropylene skins should be avoided. Exterior insulation may also be installed.
- Wood furring should be installed over rigid insulation. The rigid insulation should be continuous over the surface of the wall, except for a 2x4 furring at the intersection with the ceiling. This blocking attaches directly to the masonry block and serves as draft and fire stop. The rigid insulation abuts the blocking but does not cover it or extend behind it.
- Foam seal or caulk all top plate penetrations and exterior wall penetrations.
- Electrical boxes can be surface mounted to the masonry, avoiding chipping or chiseling. The rigid insulation, furring, and gypsum board will build up around the box for a flush finish.
- Use pressure treated lumber to frame out sub-jamb and spacers within window and door rough openings.
- As with other walls, penetrations to the exterior or through top and bottom plates should be foam sealed or caulked.
- In addition to sealing all penetrations, air leakage through the walls should be controlled by sealing the gypsum board. Pay particular attention to air sealing penetrations to garages and porches.

**FIGURE 11: Masonry Walls with Interior Rigid Insulation**



# DESIGNERS

- When pouring the slab take care to create a seat in the concrete to accept the block and seats in the concrete to act as drain pans where exterior doors and sliding doors will be located.

More information on masonry construction can be found in the *Builders Guides* (Lstiburek 2002) and on the Web at the Building America *Houses that Work* section of the Building Science Corporation Web site [www.buildingscience.com/designsthatwork/hothumid/profiles/orlando.htm](http://www.buildingscience.com/designsthatwork/hothumid/profiles/orlando.htm). Look for the *Orlando Profile*. Window flashing details can be found in the ASTM standard entitled *Standard Practice for Installation of Exterior Windows, Doors, and Skylights* (ASTM 2002) and the *EEBA Water Management Guide*. The *Water Management Guide* also contains information on other approaches to draining masonry assemblies. The *Trades*  chapter contains a building tips sheet for masonry walls.

## Concrete Walls

Some builders are beginning to use poured concrete walls for residential construction. For more information on this approach see *Builder System Performance Package Targeting 30%-40% Savings in Space Conditioning Energy Use* prepared by CARB (CARB 2004).

## Windows

**Best Practice:** Specify efficient windows to control solar energy gains and to help reduce heating and cooling loads. Some Building America experts recommend that, nationwide, windows be used with a U-factor of 0.35 or lower and a SHGC of 0.35 or less. The tradeoff in using a smaller SHGC is that the sun is blocked in both winter, when the sun helps to heat the house, and summer, when the sun works against air conditioning. In the Pacific Northwest marine climate, the heating season is longer than the air conditioning season so some solar-heating energy may be lost with low SHGC windows. In some parts of the California marine climate, air conditioning may be a bigger load than heating and a low SHGC is helpful. Note that ENERGY STAR qualification can be met with windows at less stringent ratings.

Windows are a prominent feature of any wall. High-performance windows can be an easy way to achieve ENERGY STAR qualification. Efficient windows will add expense to your project, but will provide tremendous value in comfort, durability, and energy savings. High-performance windows add so much to energy efficiency that smaller cooling and heating equipment can often be specified, which may recapture much of the cost. A voluntary rating system developed by the National Fenestration Rating Council (NFRC) provides performance information for about half the windows sold. The NFRC label contains ratings for the following features. You can find more information about the NFRC on the Web at [www.nfrc.org](http://www.nfrc.org).

- U-factors take into account the entire window assembly and rate how well the window prevents heat from passing through the window. The lower the U-factor the better the window performs at stopping heat flow. U-factors are the inverse of R-values used to measure the effectiveness of insulation. U-factor values for windows generally fall between 0.20 and 1.2.
- SHGC is the solar heat gain coefficient, which measures how well the window blocks heat caused by sunlight. The lower the SHGC rating the less solar heat the window transmits. This rating is expressed as a fraction between 0 and 1.

Les Bluestone, owner of Blue Sea Development Company in New York, said modeling of thermal bridging performed by Building America helped him cut heat loss at a multifamily development in New York that used precast concrete panels for exterior walls and wood framing for interior walls.

*“The heat was being transferred through the studs to the outside walls, and that caused a considerable amount of heat loss,” said Bluestone. “So, before we did any of the interior framing, we put up a layer of rigid insulation (½-inch expanded polystyrene board). We wrapped the entire inside of the building with this rigid insulation, creating a real thermal break for minimal transference. This made a big, big difference.”*

## WINDOWS

Specify efficient windows to control solar energy gains and to help reduce heating and cooling loads.

FIGURE 12: NFRC Window Label



ENERGY PERFORMANCE RATINGS	
U-factor (U.S./ft <sup>2</sup> )	Solar Heat Gain Coefficient
<b>0.35</b>	<b>0.32</b>
ADDITIONAL PERFORMANCE RATINGS	
Visible Transmittance	Air Leakage (U.S./ft <sup>2</sup> )
<b>0.51</b>	<b>0.2</b>

Manufacturer alleges that these ratings conform to applicable NFRC procedures for determining window performance. NFRC ratings are intended for use for environmental labeling and a specific product only. Consult manufacturer's literature for other product performance information. [www.nfrc.org](http://www.nfrc.org)

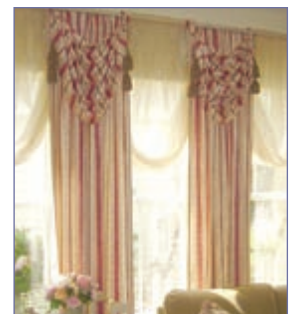

*Energy efficient windows are comfortable to sit near and provide protection for furniture and window treatments.*

# DESIGNERS

- Visible transmittance (VT) measures how much light comes through a window. VT is expressed as a number between 0 and 1. The bigger the number the more clear the glass.
- Air leakage through a window assembly is included on most manufacturers' labels, but is not required. The AL rating is expressed as the equivalent cubic feet of air passing through a square foot of window area (cfm/sq.ft.) The lower the AL, the less the window leaks. A typical rating is 0.2.
- Another optional rating is Condensation Resistance (CR), which measures the ability of a product to resist the formation of condensation on the interior surface of that product. The higher the CR rating, the better that product is at resisting condensation formation. While this rating cannot predict condensation, it can provide a credible method of comparing the potential of various products for condensation formation. CR is expressed as a number between 1 and 100, with a higher value representing more resistance to the formation of condensation.

The Efficient Windows Collaborative operates a Web site that can help designers and consumers choose windows. The Web site includes a tool that allows users to analyze energy costs and savings for windows with different ratings. Visit the Web site at [www.efficientwindows.org/index.cfm](http://www.efficientwindows.org/index.cfm).

The Web site also has fact sheets with comparisons for each state. These fact sheets could make effective marketing tools. Also described on the Web site is a book entitled *Residential Windows: A Guide to New Technologies and Energy Performance* (Carmody et al. 2000), which offers homeowners, architects, designers, and builders a fascinating look at the state of the art in window technology. Emphasizing energy performance, the book covers every aspect of window design and technology: the basic mechanisms of heat transfer; new products and rating systems; the effects of window frame material and installation; and how to make the best decisions when purchasing windows.

## Overhangs

**Best Practice:** Design roofs with overhangs to shade and protect windows and doors. Overhangs may take the form of eaves, porches, or other design features such as awnings, pergolas, or trellises.

Single glazing is not recommended, but when a house has clear single glazing, light-colored interior shades, overhangs, and combinations of shading devices significantly reduce energy costs.

Reliance on any form of shading is not nearly as important when windows with a low solar-heat-gain coefficient are used. Using a low-solar-gain low-E coating in areas dominated by air conditioning results in great energy cost reductions for all conditions even with no shading. This is because the glazing itself provides much of the control of solar radiation, so shading measures become less important in terms of energy use. For a description of the interactions between window performance and shading, see the Efficient Windows Collaborative Web site at [www.efficientwindows.org](http://www.efficientwindows.org).

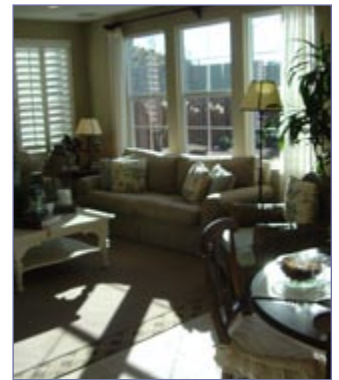

*Solar gain can be substantial in inland portions of the marine climate*

## OVERHANGS

Design roofs with overhangs to shade and protect windows and doors.

# DESIGNERS

One advantage to using overhangs is that they can be designed to allow solar gain in the winter. Low SHGC glass blocks the sun year round. Overhangs should be sized to account for differences in the angles of the sun during winter and summer. Precise overhang dimensions should be calculated for each latitude. Free and low-cost computer programs and tools are available to help. For example, a free program telling you the angle of the sun for any point in the country is available at [www.susdesign.com/sunangle/](http://www.susdesign.com/sunangle/). Latitude, longitude, and elevation data can be obtained at [www.wunderground.com](http://www.wunderground.com). Overhang dimensions can be calculated at [www.susdesign.com/overhang/index.html](http://www.susdesign.com/overhang/index.html). For a listing of free and available-for-purchase energy models, including solar design tools, see DOE's Building Technology Program Web site at - [www.eere.energy.gov/buildings/tools\\_directory/](http://www.eere.energy.gov/buildings/tools_directory/). Click on Software Tools on the lower right side. A low-cost sun angle calculator is available from the Society of Building Science Educators at [www.sbse.org/resources/sac/index.htm](http://www.sbse.org/resources/sac/index.htm).

Overhangs also provide protection from rain, hail, and the effects of overheating and ultraviolet radiation on siding and windows.

## Ceilings and Roofs

As indicated earlier, ceilings, roofs, and attics represent complex building assemblies. In addition to the sealing and insulation approaches shown in the *Air Sealing* section, here are additional insulation guidelines. These guidelines apply to traditionally ventilated attics. Unvented attics must be tightly sealed and are not described in detail in this guide. Carefully installed ceiling insulation helps to prevent ice dams.

- If attic access is provided, it must be insulated and weather-stripped.
- Use baffles to allow ventilation air to freely flow past insulation.
- Install an “energy” truss for more headroom at the eave to avoid compressing insulation and allow for complete attic insulation coverage.
- Use dams to hold insulation away from openings and storage areas. Thick batt insulation makes an excellent dam. Waxed cardboard, foam sheathing, and other sheet goods can also be used as dams.
- Only recessed lights rated for “insulated ceiling and airtight” (ICAT) should be installed in ceilings. See the section on electrical for more information.

## Heating, Ventilating and Air Conditioning (HVAC)

**Best Practice:** For the best results in comfort, efficiency, and durability, HVAC system design for both equipment and ducts must be integrated in the overall architectural design. Work closely with your HVAC engineer, HVAC contractor or HERS rater to properly design, size, and select your HVAC equipment. If done properly, you will save money and go a long way with this single step toward improved energy efficiency and comfort and substantial cost savings.

A well-designed house should have an HVAC system properly sized to its demands. Proper equipment sizing ensures a comfortable environment and provides opportunities to recapture some of the expense of an efficient building envelope. Rules of thumb for equipment sizing do not work in modern homes and should not be used.

**FIGURE 13: Overhangs**

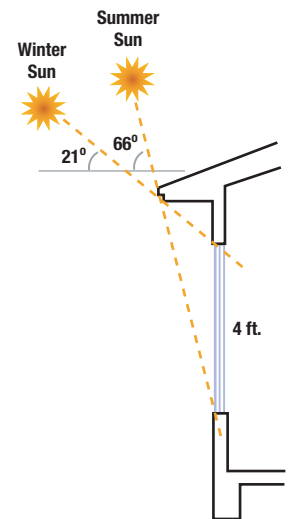

*Sun angles for Portland, Oregon. A four foot window would need an overhang extending 31 inches with 12 inches of wall above the window.*

## HVAC

Integrate HVAC system design in the overall architectural design.

# DESIGNERS

Unfortunately, rules of thumb are still prevalent. A Florida survey points out some of the practices of HVAC contractors (Viera, Parker, Klonbergo, Sonn, and Cummings 1996). Although only a small percentage of Florida's HVAC contractors responded, the survey found that about one-third of respondents size air conditioning and duct capacities based on square footage or other rules of thumb. Compounding the problem, the rules were not consistently applied. Some respondents provided twice as much capacity as others for a given square footage of floor area. Over one-third of respondents indicated intentional oversizing of HVAC equipment on some jobs, in order to avoid complaints, accommodate future expansions, enable quicker cooling down of homes, and to allow for lower cooling set points by homeowners.

## Sizing Furnaces and Air Conditioners

**Best Practice:** Right-size air conditioners and other HVAC equipment.

One estimate states that a Manual J calculation takes about 30 to 60 minutes for an average home, using the measurements from construction drawings. Manual S calculations require an additional 15 to 30 minutes (SBIC 2003). A single calculation can work for multiple use of the same plans.

### Four Sources for HVAC Design

The Air Conditioning Contractors of America (ACCA) has published simple but effective methods for determining loads and sizing ductwork and heating and cooling equipment.

- **Manual J** tells you how to calculate loads.
- **Manual D** tells you how to size ducts.
- **Manual S** guides you through the selection of appropriate heating and cooling equipment to meet identified loads.
- **Manual T** gives you the basics for small buildings.

For more information or to purchase these documents on the Web, go to [www.acca.org](http://www.acca.org).

## Air Conditioner and Heat Pump Ratings

**Best Practice:** Central air conditioners should be rated at a minimum of 13 Seasonal Energy Efficiency Ratio (SEER) for air cooling and heat pumps should be rated at a minimum of 7.7 Heating Season Performance Factor (HSPF) for heating.

In September 2006 DOE will begin enforcing a 13 SEER standard for all residential central air conditioners. For more information on this standard, visit [www.eere.energy.gov/buildings/appliance\\_standards](http://www.eere.energy.gov/buildings/appliance_standards).

Consider using SEER-14 air conditioning equipment to achieve performance levels greater than 30% savings. Equipment with SEER ratings up to 20 are now available. Currently, ENERGY STAR-labeled central air conditioners have a minimum rating of SEER 12.

*“The recommended changes in our practices meant we were able to downsize our equipment by a half-ton,” explains Andrew Nevitt, Medallion’s head architect. ‘Our contractors were concerned that they’d experience increased callbacks because of comfort issues.’ That hasn’t been the case. Medallion is building all its homes to reach ENERGY STAR performance levels and is working with Building America to learn practices that will push the performance of its homes even further.”*

As reported in *Professional Builder* 3/1/03.

### RIGHT-SIZING

Right size air conditioners and other HVAC equipment.

### FIGURE14: ACCA Manuals

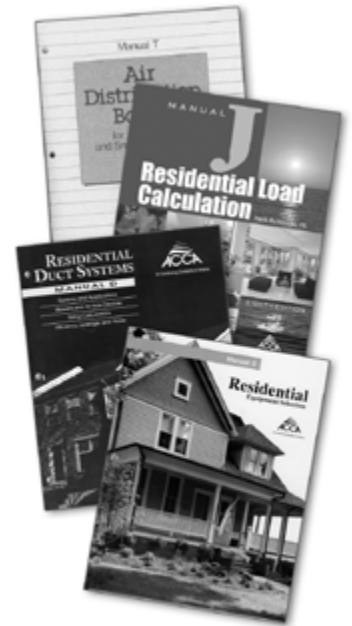

*Photos by ACCA*

### RATINGS

Central air conditioners should be rated at a minimum of 13 SEER and heat pumps should be rated at a minimum of 7.7 HSPF.

## Heat Pumps

Heat pumps are preferable to electric resistance heating in the marine climate. A unit with a HSPF of 7.7 or more will reduce the electric consumption during heating by more than 50% relative to electric resistance heating. The new standard will require that central heat pumps have a minimum rating of 7.7 HSPF. Lists of all ENERGY STAR-rated appliances can be found at [www.energystar.gov/index.cfm?c=appliances.pr\\_appliances](http://www.energystar.gov/index.cfm?c=appliances.pr_appliances).

In colder areas where temperatures often fall below 30 degrees Fahrenheit (°F), typical air source heat pumps require an electric resistance system to properly heat a home. This can be an extremely costly method of supplemental heating; a backup gas or propane furnace may be a cost-effective alternative. A newly-designed cold climate heat pump is under development but not readily available.

## Central Gas-Fired Furnace

**Best Practice:** Sealed combustion gas furnaces should be specified for central gas-fired heating systems. ENERGY STAR-labeled furnaces meet a minimum Annual Fuel Utilization Efficiency (AFUE) of 90.

### Sealed Combustion

Sealed combustion means that an appliance acquires all air for combustion through a dedicated sealed passage from the outside, to a sealed combustion chamber, and all combustion products are vented to the outside through a separate, dedicated sealed vent.

## Mechanical Ventilation

**Best Practice:** Building America recommends that whole-house mechanical ventilation be provided as specified in ASHRAE Standard 62.2. Recommended ventilation systems for indoor air quality include mechanical exhaust, systems that supply air, or a combination of the two.

- **Base Rate Ventilation:** controlled mechanical ventilation at a minimum base rate of 15 CFM for the master bedroom, plus 0.01 CFM for each square foot of conditioned area, and 7.5 CFM for each additional bedroom, should be provided, as listed in ASHRAE 62.2.
- **Spot Ventilation:** intermittent spot ventilation of 100 CFM should be provided for the kitchen; all kitchen range hoods must be vented to the outside (no recirculating hoods). Intermittent spot ventilation of 50 CFM or continuous ventilation of 20 CFM, should be provided for each washroom/bathroom. Fans should be quiet, with a sound rating of less than 1.5 sonnes.

Central fan-integrated supply ventilation can be an easy and inexpensive way to provide outside air to the HVAC system. This system provides fresh, filtered, outside air in a controlled amount using the existing HVAC delivery system for even distribution and mixing.

## GAS FURNACES

Specify sealed combustion gas furnaces for central gas-fired systems.

## Efficiency Measures for Air Conditioners, Heat Pumps, and Furnaces

The **Annual Fuel Utilization Efficiency (AFUE)** measures the amount of fuel converted to heat at the furnace outlet in proportion to the amount of fuel entering the furnace. This is commonly expressed as a percentage. A furnace with an AFUE of 90 could be said to be 90% efficient.

The **Seasonal Energy Efficiency Ratio (SEER)** is a measure of equipment energy efficiency over the cooling season. It represents the total cooling of a central air-conditioner or heat pump (in Btu) during the normal cooling season as compared to the total electric energy input (in watt-hours) consumed during the same period.

The **Heating Season Performance Factor (HSPF)** is a measure of a heat pump's energy efficiency over one heating season. It represents the total heating output of a heat pump (including supplementary electric heat) during the normal heating season (in Btu) as compared to the total electricity consumed (in Watt-hours) during the same period.

## VENTILATION

Whole-house mechanical ventilation should be provided as specified in ASHRAE Standard 62.2. Recommended ventilation systems for indoor air quality include continuous low-speed exhaust fans or balanced ventilation.

## A New Standard in Residential Ventilation

In Autumn 2003, the American Society of Heating, Refrigerating And Air-Conditioning Engineers (ASHRAE) established a new standard for indoor ventilation in residences. The standard is *ASHRAE 62.2, Ventilation and Acceptable Indoor Air Quality in Low-Rise Residential Buildings* (ASHRAE 2003). The following information is adapted from the forward that is published with the standard:

The standard contains three main sets of requirements and a host of secondary ones. The three primary sets involve whole-house ventilation, local exhaust, and source control. Whole house ventilation is intended to dilute the unavoidable contaminant emissions from people, materials, and background processes. Local exhaust is intended to remove contaminants from specific rooms, such as kitchens and bathrooms, where pollutant sources are produced. And source control measures are included to deal with other anticipated sources. The standard's secondary requirements focus on properties of specific items, such as sound and flow ratings for fans and labeling requirements.

The standard is principally about mechanical ventilation, but its purpose is to provide acceptable indoor air quality. The most effective way for keeping exposure to pollutants low is to keep them from being released to the general indoor environment in the first place.

ASHRAE has published a guidance document on meeting this standard called *62.1 User's Manual*, 2005.

*“Everyone in Oklahoma has allergies and asthma. I love to see comments on our surveys like ‘we really believe we have less allergies and asthma in this house.’”*

Vernon McKown, the co-owner of Ideal Homes in Oklahoma, who adds that he believes the fresh air ventilation system with the fan recycler is the product his customers appreciate the most.

Most of the Building America teams have designed and field-tested these ventilation systems. The systems involve exterior air intakes, ductwork running to the return air side of the HVAC system, dampers to allow control of the air intake, and electronic controls to ensure that the HVAC fans operate frequently enough to draw in adequate fresh air. For an example of these systems, see [www.buildingscience.com/resources/mechanical/fancyling/air\\_distribution.pdf](http://www.buildingscience.com/resources/mechanical/fancyling/air_distribution.pdf) for more detailed information.

**FIGURE 15: Outside Vents**

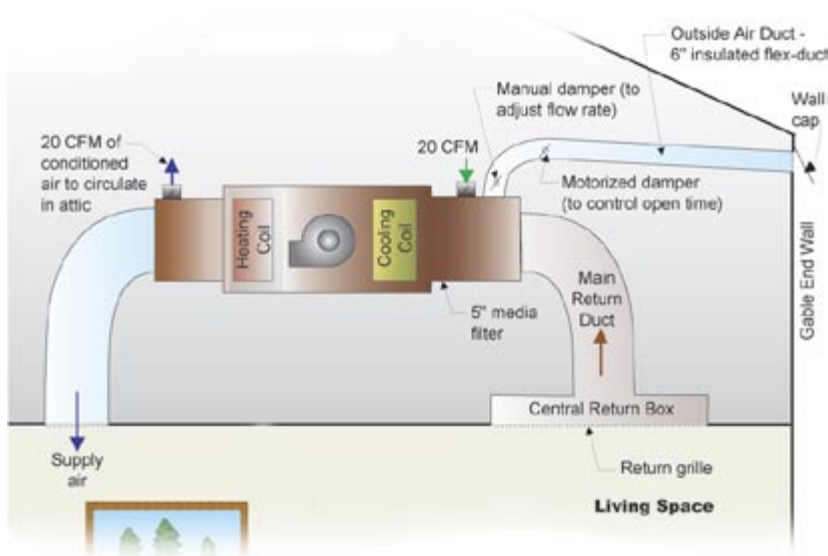

Source: Building Science Consortium

## Washington Mechanical Ventilation Requirements

The Washington State Building Code Council has implemented a “Ventilation and Indoor Air Quality Code” (WAC 51-13). WAC 51-13 is required for all residential occupancies of four stories or less. The code has both source and whole-house ventilation requirements.

Ventilation is required in rooms where excess water vapor, or cooking odor is produced – for example in kitchens, bathrooms, laundry rooms and spas. Fans will take excess water vapor or cooking odor and vent it to the outdoors, either with a continuous fan or with intermittent, manually controlled fans. Fans must have a minimum flow rating of 50 cfm for bathrooms, laundries or similar rooms, and a minimum flow rating of 100 cfm for kitchens.

Whole House ventilation is required in all residential units. Required ventilation rates are based on the building floor area and the number of bedrooms. For example a 3 bedroom, 2000 sq ft house would require between 80 and 120 cfm of outdoor air. All Whole House ventilation systems must be capable of continuous operation and must have a manual and an automatic control, such as a clock timer.

For more information, visit the Washington State Building Code Council. [www.sbcc.wa.gov](http://www.sbcc.wa.gov)

## Compact Air Distribution System

**Best Practice:** Make duct runs as short as possible. Duct may also be run through a conditioned crawlspace, conditioned basement, or conditioned attic.

An efficient building envelope and efficient HVAC equipment allow for a compact air distribution system. Conditioned air may be discharged from walls (see the discussion in the next section on chase design) or from ceiling diffusers up to 12 feet from the window wall in most cases without compromising comfort. Such “inside throw” layouts cut ductwork runs, saving money and reducing the amount of ductwork that may run in unconditioned space.

## Seal All Ducts and Air Handlers

**Best Practice:** Seal all ductwork seams and connections to air handlers with UL181-approved water-based mastic and seal drywall connections with caulk or foam sealant.

Sealing ductwork is very important. Leaky ductwork in an unconditioned attic or crawlspace can draw unhealthy air into the air distribution system. Sealing ducts with

FIGURE 16: Duct Run Configurations

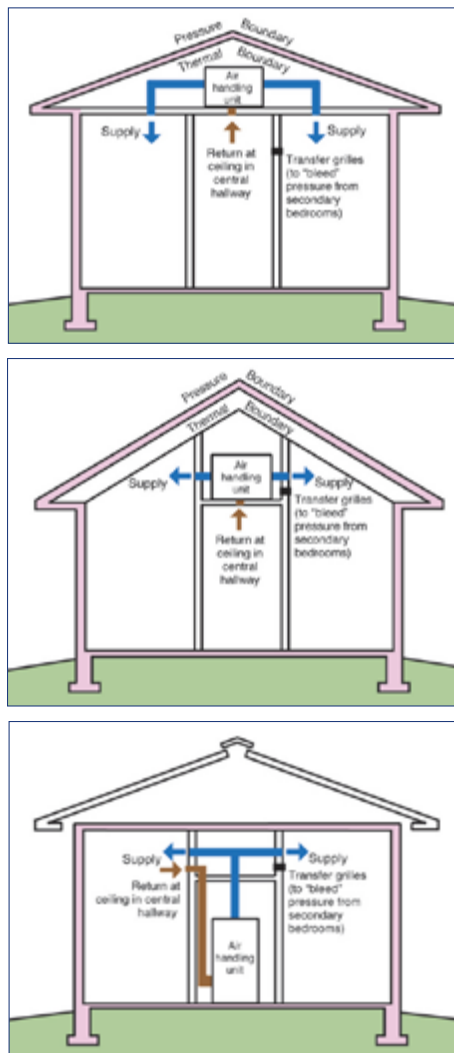

## COMPACT AIR DISTRIBUTION SYSTEM

Make duct runs as short as possible.

## DUCT SEALING

Seal all ductwork and air handlers with mastic and seal duct boots to sheetrock connections.



# DESIGNERS

mastic is desirable even for ducts located in conditioned spaces. Properly sealed ducts make sure air gets to the spaces intended, rather than leaking into a plenum space. It also minimizes the chances of creating pressure differentials from space to space that would induce airflow through the envelope. The process of sealing each joint reduces the chances of unconnected ductwork, a surprisingly common mistake.

Mastic provides the most reliable duct sealing method for new construction. All ductwork, including the air handler compartment (which typically has many leaky joints), should be mastic sealed.

DOE research has found that some tapes perform adequately for sealing ducts, particularly fiberglass duct board. However, good performing tapes may be difficult to identify and traditional duct tape (cloth-backed rubber adhesive tapes) should never be used to seal ducts, even if it meets UL ratings. Do not use sealing tapes for structural purposes. Tapes have low tensile strength and should not be used to mechanically support ducts. A technical report (Walker, Sherman, Modera, and Siegel 1998) on duct sealants can be found on the Web at <http://ducts.lbl.gov/Publications/lbl-41118.pdf> and a less technical article (Sherman and Walker 1998) on similar research can be found at [www.homeenergy.org/archive/hem.dis.anl.gov/eehem/98/980710.html](http://www.homeenergy.org/archive/hem.dis.anl.gov/eehem/98/980710.html).

California Title 24 residential building standards requires that duct sealants meet UL 181, UL 181A, UL 181B, or UL 723 (for aerosol sealants). The California Energy Commission has approved a cloth-backed duct tape with a special butyl adhesive (CEC 2005).

## Standards for Duct Sealants

Underwriters Laboratories, Inc. (UL) publishes several standards that relate to duct sealants, the most important of which is UL 181. It deals with ducts in general, with UL 181A covering field-assembled duct-board, and UL 181B covering flex duct systems. Each standard includes test procedures for sealants. Duct tapes and packing tapes that pass UL 181B are labeled “UL 181B-FX.” Mastics can pass 181A or B and are labeled “UL 181A-M” or “UL 181B-M.” Foil tapes are designated with a P.

Most tapes that are labeled 181B-FX are duct tapes. UL 181A and 181B appear to do a good job of testing for safety, tensile strength, and initial adhesion. However, they may not do a good job of rating how well sealants seal typical duct leaks or how well they stay sealed under normal conditions.

The California Energy Commission has approved a cloth-backed duct tape with a special butyl adhesive (CEC 2005).

*Adapted from Sherman and Walker 1998*

## Ducts and Air Handlers in Conditioned Space

**Best Practice:** Ducts and air handlers should be placed in conditioned spaces or buried in insulation to the extent possible. High temperatures can be found in unconditioned spaces and create an unfavorable environment for ducts and air handlers. California recognizes crawlspace placement of ducts as preferable to putting ducts in attics.

**FIGURE 17: Mastic**



*Mastic provides the most reliable duct sealing method for new construction.*

*“Sealing the ducts with mastic is I think the single most important thing that anyone should do. Sealing gets leakage rates down to about 2%. Not doing duct sealing on new construction is extremely short sighted. Mastic will last the life of the system, while conventional duct tape can fail within a year.”*

**Lucian Kragiel, Co-owner of Atlantic Design and Construction**

## DUCT RUNS

Ducts and air handlers should be placed in conditioned spaces or buried in insulation.

# DESIGNERS

**Best Practice:** As an alternative to placing ductwork in conditioned space, Building America research has shown that in the hot-dry and mixed-dry climates, burying attic ducts in insulation is acceptable. California code (Title 24) does not restrict the use of buried ducts in the marine climate. The approach is described in California's *2005 Building Energy Efficiency Standards Residential Compliance Manual* (CEC 2005). Where cooling is used in areas of high humidity, condensation could form on duct surfaces.

Ducts and air handlers perform best when placed within conditioned space. Keeping ducts inside conditioned space may require one of several strategies, such as:

- 1) Placing ducts in a chase designed to run through a central corridor below the attic or on top of the ceiling through the attic. If the chase runs through the attic, it must fit within the roof truss design and will be covered with insulation. For more information on designing and building an interior chase see the report, *Design and Construction of Interior Duct Systems* (McIlvaine, Beal, and Fairey 2001), available on the Web at [www.fsec.ucf.edu/bldg/baihp//pubs/interior\\_ducts.pdf](http://www.fsec.ucf.edu/bldg/baihp//pubs/interior_ducts.pdf).
- 2) Insulating and sealing the underside of the roof sheathing to create a conditioned attic. This strategy requires tightly sealing the roof structure, especially where it connects with the walls, to avoid the entry of outside air. This technique essentially requires building a non-vented roof assembly. For more information on this technique see [www.buildingscience.com/resources/roofs/unvented\\_roof\\_summary\\_article.pdf](http://www.buildingscience.com/resources/roofs/unvented_roof_summary_article.pdf). This approach may require a variance from local code officials.
- 3) In houses with a crawlspace, insulating and sealing the exterior walls of the crawlspace so that it becomes a conditioned space, such as a mini basement. This strategy requires treating the crawlspace much like a living space with conditioned air supply, moisture control, and air returns to the HVAC system. More information on this approach can be found at [www.buildingscience.com/designthatwork/hothumid/profiles/montgomery.htm](http://www.buildingscience.com/designthatwork/hothumid/profiles/montgomery.htm).

Air handlers should be placed inside conditioned space. One approach is to build a conditioned closet with sealed access from the garage. In addition to improving the efficiency of the equipment, this approach adds additional square footage to the conditioned space.

California Title 24 residential building standards requires that duct sealants meet UL 181, UL 181A, UL 181B, or UL 723 (for aerosol sealants). The California Energy Commission has approved a cloth-backed duct tape with a special butyl adhesive (CEC 2005).

## Duct Insulation

**Best Practice:** Ducts in unconditioned spaces must be insulated.

To the extent possible, ducts should be placed inside conditioned space. In conditioned spaces, they require minimal insulation. If the ducts are placed in unconditioned spaces, due to the extreme summer temperatures in these spaces, 10% to 30% of the energy used to cool the air can be lost to conduction through the duct surfaces. Therefore, they must be insulated. Codes typically require R-8 insulation levels for ducts in unconditioned attics and crawlspaces.



*Properly sized and sealed ducts, kept inside conditioned space, improve performance and reduce cost.*  
Source: IBACOS

## DUCTS BURIED IN INSULATION

Based on Building America research, California's Title 24 includes provisions for buried and deeply buried ducts in attics.

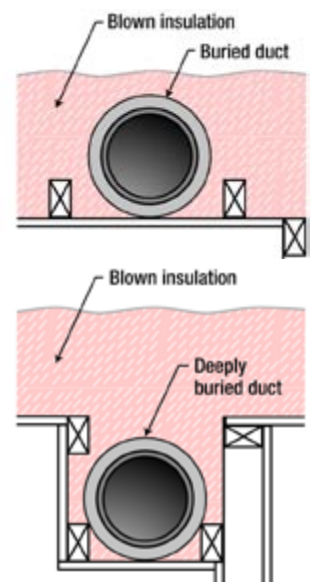

## INSULATING DUCTS

Ducts in unconditioned spaces must be insulated.

**FIGURE 18: Approaches to Pressure Balancing**

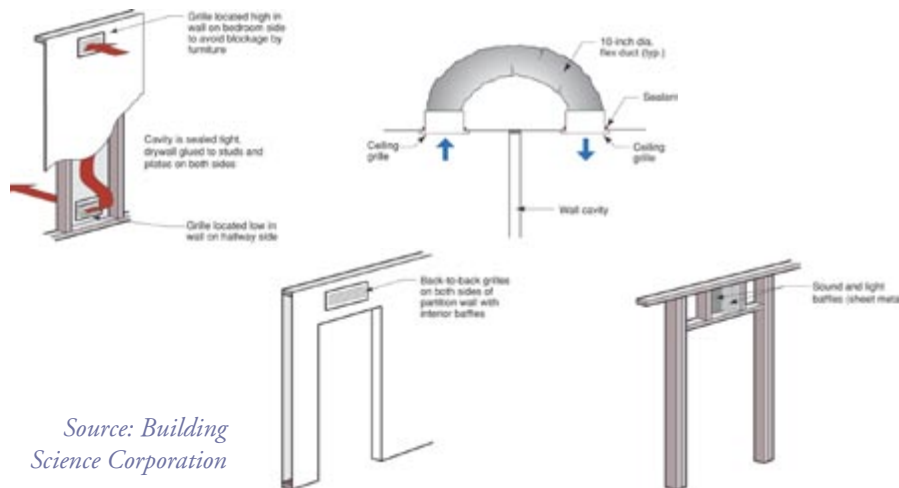

## Transfer Grilles and Jump Ducts

**Best Practice:** Use jump ducts and transfer grilles and other return pathways to maintain balanced pressure in rooms that are often isolated from the rest of the house by a closed door, such as a bedroom.

To maintain balanced pressure, air must be returned from each room to the central HVAC equipment. One way to do this would be to add a ducted return from each room. However, this would be expensive and consume a lot of space. A cost-effective approach is to provide a central return and make sure that there are transfer grilles or transfer ducts, of adequate size, that allow air to pass from individual rooms to the central return even when doors are closed. Figure 18 illustrates different approaches to creating paths to equalize air pressure and allow air to return to HVAC equipment. When designing registers and transfer grilles, place them high on the wall in areas where furniture may block air movement.

## Draw Duct Layouts on Plans

**Best Practice:** Clearly identify on plans and drawings the locations, sizes, and types for all duct work and registers, including the heating and cooling supply ducts, passive return air ducts or transfers, the locations for the mechanical ventilation air inlet (at least 8 feet away from any exhausts or condensers), and all exhaust outlets. If chases or other spaces are to be dedicated to duct runs, indicate this on the plans.

This level of detail can be referenced in contract documents so you know exactly what you will be getting. These documents can provide guidance in the field for proper installation.

## Energy Performance and Commissioning

**Best Practice:** The *Site Supervisors*  chapter includes a list of commissioning inspections and tests that cover all phases of construction.

Building Science Corporation has identified performance testing as a key reason for substantial reductions in callbacks (BSC 2003).

*“The biggest source of leakage in the ducts is when there is no caulking between the drywall and the “can” which holds the duct to the register. If the can is not sealed to the drywall, we estimate 40% leakage can occur there alone.”*

Doug Dryer, ConSol’s national sales manager

## BALANCED PRESSURE

Use jump ducts and transfer grilles and other return pathways to maintain balanced pressure in bedrooms and other isolated rooms.

**FIGURE 19: Jump Ducts**



Source: IBACOS

## DUCT WORK LOCATION

Clearly identify on plans and drawings the locations, sizes, and types for all duct work and registers.

## EVALUATION

Specify commissioning and test procedures.

## Occupant Health and Safety

The following best practices should be included in the house design:

- All combustion appliances in the conditioned space must be sealed combustion or power-vented. Specifically, any furnace inside conditioned space shall be a sealed-combustion 90%+ (AFUE of 90 or greater) unit. Any water heater inside conditioned space shall be power vented or power-direct vented. Designs that incorporate passive combustion air supply openings or outdoor supply air ducts not directly connected to the appliance should be avoided.
- Gas cooking ranges should be tuned to a blue flame and should be equipped with an exhaust fan. Typically there is no requirement for make-up air.
- Use sealed-combustion gas fireplaces to eliminate the threat of harmful combustion gases from entering the house. All fuel-burning fireplaces should have sealed combustion and be properly vented to the outside. If not properly vented and sealed, the fireplace can produce harmful combustion pollutants that may be emitted into the home, such as carbon monoxide, nitrogen dioxide, and sulfur dioxide.
- Provide filtration systems for forced air systems that provide a minimum atmospheric dust spot efficiency of 30% or MERV of 6 or higher. MERV (Minimum Efficiency Reporting Value) is a measure of an air filter's efficiency at removing particles. A fiberglass panel filter may have a MERV of 4 or 5. Critical areas in hospitals may use a MERV 14 filter. Electronic air cleaners should be used with caution because the ozone they produce may affect sensitive individuals.
- Indoor humidity should be maintained in the range of 25% to 60% by controlled mechanical ventilation, mechanical cooling, or dehumidification. See [www.buildingscience.com/resources/moisture/relative\\_humidity\\_0402.pdf](http://www.buildingscience.com/resources/moisture/relative_humidity_0402.pdf).
- Carbon monoxide detectors (hard-wired units) shall be installed (at one per every approximate 1,000 square feet) in any house containing combustion appliances and/or an attached garage.
- Maximize hard surface areas (tile, vinyl, hardwood) to better manage dust for health purposes. For slab-on-grade houses, it also reduces the cooling loads.
- Information relating to the safe, healthy, comfortable operation and maintenance of the building and systems that provide control over space conditioning, hot water, or lighting energy use shall be provided to occupants.

## Mechanicals Management and Appliances

### Plumbing

Water heater efficiency is described by the energy factor rating. The Consumers' Directory of Certified Efficiency Ratings, Gas Appliance Manufacturers Association (GAMA) provides a concise listing of energy factors for water heaters of all fuel types at [www.gamanet.org](http://www.gamanet.org).

**FIGURE 20: Additional Plumbing Air Sealing Building Tips can be found in the Trades Chapter.**

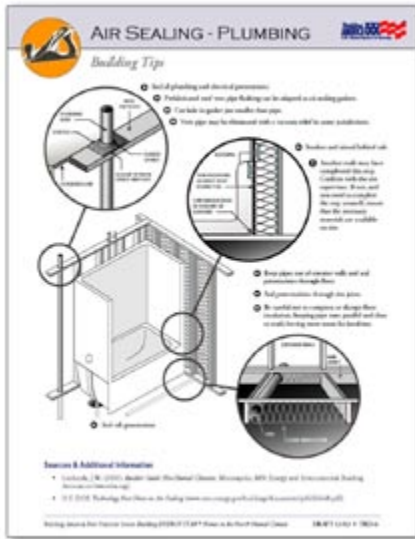

**Best Practice:** Do not install plumbing in exterior walls. Seal around plumbing penetrations in all exterior surfaces, surfaces that border on unconditioned spaces, and between floors. Use fire-resistant sealant in plates between floors.

**Best Practice:** Water heaters can be located in the basement or a conditioned crawlspace (space permitting) or enclosed within a closet. If enclosed, ventilation grilles may be needed to provide combustion air. Water heaters located in conditioned spaces should be power vented or power-direct vented.

Air admittance vents may be accepted in some jurisdictions and can help reduce the quantity of needed vent pipes. More information can be found at [www.toolbase.org](http://www.toolbase.org).

### Water Heaters

Water heaters come in many shapes, sizes, and efficiencies. The Oregon Department of Energy maintains a list of high-efficiency water heaters that qualify for state tax credits. The list contains high-efficiency gas combustion water heaters, instantaneous (tankless) water heaters, and water heating heat pumps. You may consider these products for your projects. The tax credits only apply to Oregon installations by Oregon taxpayers. See the list at: [www.energy.state.or.us/res/tax/appheat.htm](http://www.energy.state.or.us/res/tax/appheat.htm).

**Best Practice:** Be sure to specify insulation requirements for pipes, especially pipes that will be covered by the slab, or will otherwise be inaccessible.

**Best Practice:** Design plumbing runs to be as short as possible. “Homerun” type systems also effectively serve baths and other areas with hot water demands. Avoid the use of recirculating pumps. If used, the pumps should be controlled by timers or on-demand to stop continuous operation.

### PLUMBING SEALING

Seal plumbing penetrations in exterior surfaces and keep plumbing out of exterior walls.

### WATER HEATERS

Water heaters located in a conditioned space must be power-vented or power-direct vented.

**FIGURE 21: Hot Water Distribution Systems**

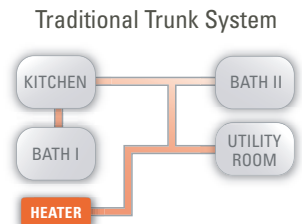

More Efficient Manifold System

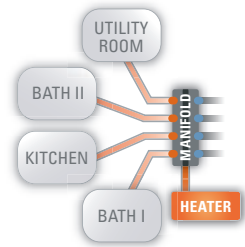

### SPECIFY INSULATION REQUIREMENTS

Be sure to specify insulation requirements for pipes, especially pipes that will be inaccessible.

### EFFICIENT PLUMBING RUNS

Keep runs short or use homerun systems and avoid the use of recirculating pumps.

## Electrical

**Best Practice:** Seal around wires penetrating all exterior surfaces, surfaces that border on unconditioned spaces, and between floors. Use fire-resistant sealants between floors. If recessed downlights are to be used they should be rated for insulated ceilings and airtight (ICAT).

ICAT is a combination of two standards. The first is ASTM E283, the standard for testing restricted air movement (ASTM 2004) and the second is Underwriters Laboratory standard for direct burial in insulation contained in the Luminaires standard (UL 1598). The ICAT standard originated in the State of Washington building code and now, as part of the International Energy Efficiency code, covers almost 75% of the country's population. See the *Trades*  chapter for *Building Tips* for electricians for more information.

Consider the use of recessed downlights and other fixtures that qualify for ENERGY STAR labels. Highly energy-efficient recessed downlight fixtures that have undergone stringent testing are available for purchase at the following DOE sponsored Web site: [www.pnl.gov/cfldownlights/](http://www.pnl.gov/cfldownlights/). The lights featured are ICAT rated and hard-wired for compact fluorescent bulbs. Fixed prices have been negotiated for the featured fixtures. Using compact fluorescent lamps in lighting fixtures will reduce energy usage and produce less heat.

## Appliances

Major appliances meet high-energy efficiency standards using current appliance ratings. Only those appliances in the top one-third of the DOE Energy Guide rating scale should be selected (see list at: [www.eere.energy.gov/consumerinfo/energy\\_savers/appliances.html](http://www.eere.energy.gov/consumerinfo/energy_savers/appliances.html)). One approach is to use appliances with the ENERGY STAR label.

**FIGURE 22: Additional Electrical Air Sealing Building Tips are available in the *Trades* chapter.**

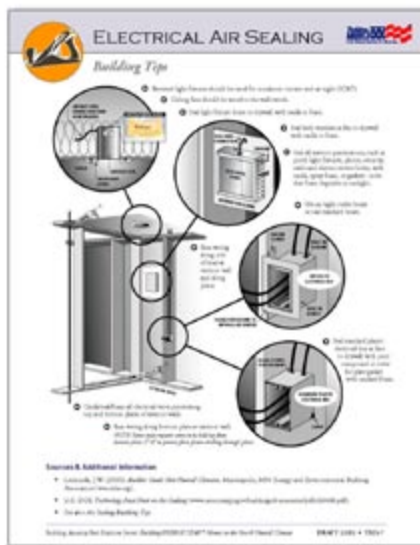

## ELECTRICAL SEALING

Seal all wire penetrations.

## Sources & Additional Information

- Air Conditioning Contractors of America. *Manual D: Residential Duct Systems*. ACCA, Arlington, VA. [www.acca.org](http://www.acca.org).
- Air Conditioning Contractors of America. *Manual J: Residential Load Calculation, Eighth Edition*. ACCA, Arlington, VA. [www.acca.org](http://www.acca.org).
- Air Conditioning Contractors of America. *Manual S: Residential Equipment Selection*. ACCA, Arlington, VA. [www.acca.org](http://www.acca.org).
- Air Conditioning Contractors of America. *Manual T. Air Distribution Basics for Residential and Small Commercial Buildings*. ACCA, Arlington, VA. [www.acca.org](http://www.acca.org).
- The American Society of Civil Engineers standard (number 32-01). *Design and Construction of Frost-Protected Shallow Foundations*.
- American Society of Heating, Refrigerating, and Air-Conditioning Engineers, Inc (ASHRAE). 2005. *62.1 User's Manual*. ASHRAE, Atlanta, GA.
- American Society of Heating, Refrigerating, and Air-Conditioning Engineers, Inc (ASHRAE). 2003. *ASHRAE Standard: Ventilation and Acceptable Indoor Air Quality in Low-Rise Residential Buildings*. ASHRAE, Atlanta, GA.
- ASTM 2002. *Standard Practice for Installation of Exterior Windows, Doors, and Skylights*. ASTM E2112-01.
- ASTM 2003. *WK2469 New Standard (Formerly E1465-92) Guide for Radon Control Options for the Design and Construction of New Low Rise Residential Buildings*.
- ASTM 2004. *Standard Test Method for Determining Rate of Air Leakage through Exterior Windows, Curtain Walls, and Doors Under Specified Pressure Differences across the Specimen*. ASTM E283-04.
- Broniek, John. 2003. *Builder System Performance Packages Technical Report*. Prepared by IBACOS for the Building America Program. [www.buildingamerica.gov](http://www.buildingamerica.gov)
- Building Energy Codes Resource Center. *Details for Mechanically Vented Crawlspace - Code Notes*. [www.energycodes.gov/support/code\\_notes.stm](http://www.energycodes.gov/support/code_notes.stm)
- Building Science Corporation (BSC). 2002. 10. *Case Study Material: Conditioning Air in the Humid South*. National Renewable Energy Laboratory, Golden, CO.
- Building Science Corporation (BSC). 2003. 9. *BSC Final Report: Lessons Learned from Building America Participation, February 1995-December 2002*. National Renewable Energy Laboratory, Golden, CO.
- Building Science Corporation (BCS). 2003b. 1.C.2.1 *Report Expert Meeting Summary*. National Renewable Energy Laboratory, Golden, CO.
- Building Science Corporation (BCS). 2004. *Houses that Work*. [www.bsc.com](http://www.bsc.com)
- Building Science Corporation (BCS). 2006. *Vapor Barriers and Wall Design*.
- Building Science Corporation (BCS). 2006. *Vapor Barriers and Wall Design*. Available at [www.buildingscience.com/resources/walls/Vapor\\_Barriers\\_Wall\\_Design.pdf](http://www.buildingscience.com/resources/walls/Vapor_Barriers_Wall_Design.pdf).
- California Energy Commission. 2005. *2005 Residential Compliance Manual*. Sacramento, CA. [www.energy.ca.gov/2005publications/CEC-400-2005-005/CEC-400-2005-005-CMF.pdf](http://www.energy.ca.gov/2005publications/CEC-400-2005-005/CEC-400-2005-005-CMF.pdf).

# DESIGNERS

- CARB (Consortium for Advanced Residential Buildings). 2004. *Builder System Performance Package Targeting 30%-40% Savings in Space Conditioning Energy Use: NREL/SR-550-34560*. National Renewable Energy Laboratory, Golden, CO. Available at [www.buildingamerica.gov](http://www.buildingamerica.gov).
- Carmody, John, Stephen Selkowitz, Dariush Arasteh and Lisa Heschong. 2000. *Residential Windows: A Guide to New Technologies and Energy Performance*. W. W. Norton and Company, New York. [www.wwnorton.com/npb/welcome.htm](http://www.wwnorton.com/npb/welcome.htm).
- U.S. Department of Energy (DOE). 2000. *Technology Fact Sheet on Weather Resistive Barriers*. DOE/GO-102000-0769, Washington D.C. Available on the Web at [www.eere.energy.gov/buildings/documents/pdfs/28600.pdf](http://www.eere.energy.gov/buildings/documents/pdfs/28600.pdf).
- U.S. Department of Energy (DOE), Office of Building Technology. 2002. *Technology Fact Sheet: Basement Insulation*.
- U.S. Department of Energy (DOE). 2000. *Energy Savers Fact Sheet on Vapor Diffusion Retarders and Air Barriers* [www.eere.energy.gov/consumerinfo/factsheets/bd4.html](http://www.eere.energy.gov/consumerinfo/factsheets/bd4.html)
- Edminster, Ann, Betsy Pettit, Kohta Ueno, Stephanie Menegus, and Steven Baczek. 2000. "Case Studies in Resource-Efficient Residential Building: The Building America Program." *2000 ACEEE Summer Study Proceedings*. ACEEE, Washington, D.C.
- Garrison, Tim. 2004. *Nation's Building News Online*, 27 April 2004. [www.nbnnews.com](http://www.nbnnews.com).
- IBACOS. 2002. *Best Practices: Consider the Crawlspace*.
- IBACOS. 2002. *Don't Forget About the Basement*. Prepared by IBACOS for the Building America Program. [www.buildingamerica.gov](http://www.buildingamerica.gov)
- Institute for Business and Home Safety. The IBHS has building guidelines and public information. [www.ibhs.org](http://www.ibhs.org).
- Karagiozis, Achilles. 2002a. "A North American Research Approach to Moisture Design by Modeling." *Proceedings of Building Physics 2002 – 6th Nordic Symposium*. Gustavsen, A. and J.V. Thue, editors, Norwegian University of Science and Technology, Trondheim, Norway.
- Karagiozis, Achilles. 2002b. *Building Enclosure Hygrothermal Performance Study Phase I*. Prepared by the Oak Ridge National Laboratory for the U.S. Department of Energy, Oak Ridge, Tennessee.
- Lstiburek, Joseph. 2001. *EEBA Builders Guide: Mixed-Humid Climates*. EEBA, Minneapolis, MN. [www.eeba.org/bookstore](http://www.eeba.org/bookstore).
- Lstiburek, Joseph. 2002. *EEBA Builders Guide: Hot and Humid Climates*. EEBA, Minneapolis, MN. [www.eeba.org/bookstore](http://www.eeba.org/bookstore).
- Lstiburek, Joseph. 2003. *EEBA Water Management Guide*. EEBA, Minneapolis, MN. [www.eeba.org/bookstore](http://www.eeba.org/bookstore).
- Lstiburek, Joseph. 2004. *Builder's Guide to Hot-Dry/Mixed-Dry Climates*. Building Science Press, Westford, MA. [www.buildingsciencepress.com](http://www.buildingsciencepress.com)
- Lstiburek, Joseph. 2004. *Builder's Guide to Mixed-Humid Climates*. Building Science Press, Westford, MA. [www.buildingsciencepress.com](http://www.buildingsciencepress.com)
- Lstiburek, Joseph. 2004. *Builder's Guide to Hot/Humid Climates*. Building Science Press, Westford, MA. [www.buildingsciencepress.com](http://www.buildingsciencepress.com)
- McIlvaine, Janet; David Beal; and Philip Fairey, III. 2001. *Design and Construction of Interior Duct System. Report Number FSEC-PF-365-01*, Florida Solar Energy Center, Cocoa, FL. [www.fsec.ucf.edu/bldg/baihp//pubs/interior\\_ducts.pdf](http://www.fsec.ucf.edu/bldg/baihp//pubs/interior_ducts.pdf).



## DESIGNERS

- Murry, Chuck. 2005. Comparing the Moisture Performance of Wood Framed Wall Systems in the Pacific Northwest. WSUEEP05-020 9/26/2005. Prepared for the Roof Consultant Institute/Building Envelope Institute 2005 Symposium on Building Envelope Technology. Washington State University Extension Energy Program. Olympia, WA.
- Parker, D.S.; J. R. Sherwin; and M. T. Anello, 2001. “FPC Residential Monitoring Project: New Technology Development — Radiant Barrier Pilot Project,” *Contract Report FSEC-CR-1231-01*, Florida Solar Energy Center, Cocoa, FL. [www.fsec.ucf.edu/bldg/pubs/rbs/index.htm](http://www.fsec.ucf.edu/bldg/pubs/rbs/index.htm).
- Rudd, Armund. 2003. *Refrigeration System Installation and Startup Procedures, and Air Conditioning System Efficiency*. Building Science Corporation, Westford, MA. [www.buildingscience.com/resources/mechanical/air\\_conditioning\\_equipment\\_efficiency.pdf](http://www.buildingscience.com/resources/mechanical/air_conditioning_equipment_efficiency.pdf).
- Sherman, Max and Iain Walker. 1998. “Can Duct Tape Take the Heat?” *Home Energy*, Berkeley, CA. [www.homeenergy.org/898ductape.title.html](http://www.homeenergy.org/898ductape.title.html).
- Straube, John. 2001. *Canadian Architect*. “Wrapping it Up”. May, 2001. [www.cdnarchitect.com](http://www.cdnarchitect.com).
- (SBIC) Sustainable Buildings Industry Council. 2003. *Green Building Guidelines: Meeting the Demand for Low-Energy, Resource-Efficient Homes*. U.S. DOE. Washington, D.C. document available at [www.SBICouncil.org](http://www.SBICouncil.org).
- Treidler, B.; M.P. Modera; R.G. Lucas; J.D. Miller. 1996. *Impact of Residential Duct Insulation on HVAC Energy Use and Life-Cycle costs to Consumers*. ASHRAE Transactions: Symposia, AT-96-13-4. American Society of Heating, Refrigerating, and Air Conditioning Engineers, Atlanta, GA.
- University of Minnesota, Building Foundations Research Program. *Frost Protected Shallow Foundations Design Specifications*. [www.buildingfoundation.umn.edu/MHFAfrostFoundation.htm](http://www.buildingfoundation.umn.edu/MHFAfrostFoundation.htm)
- University of Minnesota, Building Foundations Research Program. *Minnesota Energy Code Building Foundation Rule: Amendment Proposal Development Project Final Report*. [www.buildingfoundation.umn.edu/FinalReportWWW/Section-A/A-recs-main.htm](http://www.buildingfoundation.umn.edu/FinalReportWWW/Section-A/A-recs-main.htm)
- U.S. Environmental Protection Agency. 1994. *Model Standards and Techniques for Control of Radon in New Residential Buildings*.
- U.S. Environmental Protection Agency. 2000. *Duct Insulation: Air Distribution System Improvements*. EPA 430-97-028. Washington, D.C. [www.energystar.gov/ia/new\\_homes/features/DuctInsulation1-17-01.pdf](http://www.energystar.gov/ia/new_homes/features/DuctInsulation1-17-01.pdf).
- U.S. Environmental Protection Agency. 2001. *Building Radon Out: A Step by Step Guide on How to Build Radon Resistant Homes*. [www.epa.gov/radon/images/buildradonout.pdf](http://www.epa.gov/radon/images/buildradonout.pdf).
- Viera, Robin K.; Parker, Danny S.; Klongerbo, Jon F.; Sonne, Jeffrey K.; Cummings, Jo Ellen. 1996. “How Contractors Really Size Air Conditioning Systems.” Florida Solar Energy Center, Cocoa, FL. [www.fsec.ucf.edu/bldg/pubs/ACsize/index.htm](http://www.fsec.ucf.edu/bldg/pubs/ACsize/index.htm).
- Walker, I.; M. Sherman; M. Modera; and J. Siegel. 1998. *Leakage Diagnostics, Sealant Longevity, sizing and Technology Transfer in Residential Thermal Distribution Systems*. Lawrence Berkeley National Laboratory, Berkeley, CA. <http://ducts.lbl.gov/Publications/lbl-41118.pdf>.
- Washington State Building Code Council. [www.sbcc.wa.gov](http://www.sbcc.wa.gov)
- Yost, Nathan. May 2003. “The Case for Conditioned Unvented Crawlspace.” *Building Safety Journal*. [www.buildingscience.com/resources/articles/24-27\\_Yost\\_for\\_author.pdf](http://www.buildingscience.com/resources/articles/24-27_Yost_for_author.pdf).
- Yost, Nathan, and Joseph Lstiburek. 2002. *Basement Insulation Systems*. Prepared by the Building Science Consortia for the Building America Program. [www.buildingamerica.gov](http://www.buildingamerica.gov)

## Web Sites Not Included with Published Documents Above

(See Appendix V for more information on Web sites.)

- [www.blueprintforsafety.org](http://www.blueprintforsafety.org)
- [www.buildingamerica.gov](http://www.buildingamerica.gov)
- [www.buildingscience.com/designsthatwork/airsealing/default.htm](http://www.buildingscience.com/designsthatwork/airsealing/default.htm)
- [www.buildingscience.com/designsthatwork/advancedframing/default.htm](http://www.buildingscience.com/designsthatwork/advancedframing/default.htm)
- [www.buildingscience.com/designsthatwork/buildingmaterials.htm](http://www.buildingscience.com/designsthatwork/buildingmaterials.htm)
- [www.buildingscience.com/designsthatwork/hothumid/profiles/montgomery.htm](http://www.buildingscience.com/designsthatwork/hothumid/profiles/montgomery.htm)
- [www.buildingscience.com/designsthatwork/hothumid/profiles/orlando.htm](http://www.buildingscience.com/designsthatwork/hothumid/profiles/orlando.htm)
- [www.buildingscience.com/resources/mechanical/advanced\\_space\\_conditioning.pdf](http://www.buildingscience.com/resources/mechanical/advanced_space_conditioning.pdf)
- [www.buildingscience.com/resources/moisture/relative\\_humidity\\_0402.pdf](http://www.buildingscience.com/resources/moisture/relative_humidity_0402.pdf)
- [www.buildingscience.com/resources/roofs/unvented\\_roof\\_summary\\_article.pdf](http://www.buildingscience.com/resources/roofs/unvented_roof_summary_article.pdf)
- [www.buildingscience.com/resources/walls/problems\\_with\\_housewraps.htm](http://www.buildingscience.com/resources/walls/problems_with_housewraps.htm)
- [www.buildingscience.com/resources/walls/default.htm](http://www.buildingscience.com/resources/walls/default.htm)
- [www.certainteed.com/pro/insulation](http://www.certainteed.com/pro/insulation)
- [www.crawlspaces.org](http://www.crawlspaces.org)
- [www.eere.energy.gov/buildings](http://www.eere.energy.gov/buildings)
- [www.eere.energy.gov/consumerinfo/energy\\_savers/appliances.html](http://www.eere.energy.gov/consumerinfo/energy_savers/appliances.html)
- [www.eere.energy.gov/consumer/your\\_home/insulation\\_airsealing/index.cfm/mytopic=11340](http://www.eere.energy.gov/consumer/your_home/insulation_airsealing/index.cfm/mytopic=11340)
- [www.eere.energy.gov/consumerinfo/factsheets/landscape.html](http://www.eere.energy.gov/consumerinfo/factsheets/landscape.html)
- [www.eere.energy.gov/weatherization/hazard\\_workshop.html](http://www.eere.energy.gov/weatherization/hazard_workshop.html)
- [www.efficientwindows.org/index.cfm](http://www.efficientwindows.org/index.cfm)
- [www.energycodes.gov](http://www.energycodes.gov)
- [www.energy.state.or.us/res/tax/appheat.htm](http://www.energy.state.or.us/res/tax/appheat.htm)
- [www.energystar.gov/index.cfm?c=bop\\_pt\\_bop\\_index](http://www.energystar.gov/index.cfm?c=bop_pt_bop_index)
- [www.energystar.gov/index.cfm?c=new\\_homes\\_hm\\_earn\\_star](http://www.energystar.gov/index.cfm?c=new_homes_hm_earn_star)
- [www.epa.gov/iaq/whereyoulive.html](http://www.epa.gov/iaq/whereyoulive.html)
- [www.epa.gov/radon/zonemap.html](http://www.epa.gov/radon/zonemap.html)
- [www.fema.gov](http://www.fema.gov)
- [www.fsec.ucf.edu/bldg/science/basics/index.htm](http://www.fsec.ucf.edu/bldg/science/basics/index.htm)
- [www.fsec.ucf.edu/bldg/pubs/rbs/index.htm](http://www.fsec.ucf.edu/bldg/pubs/rbs/index.htm)
- [www.gamanet.org](http://www.gamanet.org)
- [www.ibacos.com/bestprac.html](http://www.ibacos.com/bestprac.html)
- [www.ibacos.com/qhome/Aug03/Sug2003\\_bp\\_brick.html](http://www.ibacos.com/qhome/Aug03/Sug2003_bp_brick.html)
- [www.ibacos.com/qhome/Aug04/Aug2004\\_Water.html](http://www.ibacos.com/qhome/Aug04/Aug2004_Water.html)
- [www.ibacos.com/qhome/Jan04/bestpractice.pdf](http://www.ibacos.com/qhome/Jan04/bestpractice.pdf)
- [www.ibacos.com/qhome/Jan04/Jan\\_BPWebBasements.html](http://www.ibacos.com/qhome/Jan04/Jan_BPWebBasements.html)
- [www.ibacos.com/qhome/June03/wtrhtr.html](http://www.ibacos.com/qhome/June03/wtrhtr.html)
- [www.ibacos.com/qhome/March03/march03\\_bestpractices\\_roofflashing.html](http://www.ibacos.com/qhome/March03/march03_bestpractices_roofflashing.html)
- [www.ibacos.com/qhome/March03/march03\\_cover.html](http://www.ibacos.com/qhome/March03/march03_cover.html)
- [www.ibacos.com/qhome/March04/Mar\\_BP Roofs.html](http://www.ibacos.com/qhome/March04/Mar_BP Roofs.html)
- [www.ibacos.com/qhome/March04/Mar\\_Tech\\_VentedAttics.html](http://www.ibacos.com/qhome/March04/Mar_Tech_VentedAttics.html)
- [www.ibacos.com/qhome/Oct03/duct.html](http://www.ibacos.com/qhome/Oct03/duct.html)

# DESIGNERS

- [www.ibacos.com/qhome/Winter05/winter05\\_bestpractices\\_drainage\\_plane.html](http://www.ibacos.com/qhome/Winter05/winter05_bestpractices_drainage_plane.html)
- [www.ibacos.com/hpl.html](http://www.ibacos.com/hpl.html)
- [www.ibacos.com/pubs/Newsletter-July02.pdf](http://www.ibacos.com/pubs/Newsletter-July02.pdf)
- [www.ibacos.com/pubs/Newsletter-July02.pdf#page=3](http://www.ibacos.com/pubs/Newsletter-July02.pdf#page=3)
- [www.nahbr.org/docs/mainnav/moistureandleaks/792\\_moisture.pdf](http://www.nahbr.org/docs/mainnav/moistureandleaks/792_moisture.pdf)
- [www.natresnet.org](http://www.natresnet.org)
- [www.nfrc.org](http://www.nfrc.org)
- [www.ornl.gov/sci/roofs+walls/insulation/ins\\_16.html](http://www.ornl.gov/sci/roofs+walls/insulation/ins_16.html)
- [www.ornl.gov/sci/roofs+walls/radiant/rb\\_01.html](http://www.ornl.gov/sci/roofs+walls/radiant/rb_01.html)
- [www.pnl.gov/cfldownlights/](http://www.pnl.gov/cfldownlights/)
- [www.sbcc.wa.gov](http://www.sbcc.wa.gov)
- [www.sbse.org/resources/sac/index.htm](http://www.sbse.org/resources/sac/index.htm)
- [www.susdesign.com/sunangle](http://www.susdesign.com/sunangle)
- [www.toolbase.org](http://www.toolbase.org)
- [www.uky.edu/Agriculture/Entomology/entfacts.htm](http://www.uky.edu/Agriculture/Entomology/entfacts.htm)
- [www.wunderground.com](http://www.wunderground.com)



# SITE SUPERVISORS

## Tools to help with project management

In the chain of events that results in a finished home, the site supervisor (or project manager) has the critical job of turning ideas into reality. The site supervisor's job is to make sure everything happens. Plans must be correct, permits must be in order, contracts must be signed, subcontractors must be scheduled, materials must be on site, and it all must happen on schedule. Successful construction of an energy-efficient home is essentially the same as other homes, although a few details are different and can demand more careful scrutiny because of the interdependencies in a systems-designed house.

Site supervisors working to build energy-efficient homes can generally do their jobs as they already know how, with a few simple but important changes. There are three keys to constructing any quality home—managing expectations, managing the schedule, and controlling quality and costs. This section will explain how to incorporate those three keys into your construction process.

An energy-efficient home built using these Building America recommendations looks a lot like any other home. It will maintain its visual appeal and style. The key points at which it differs typically involve more efficient heating, ventilating, and air conditioning (HVAC) equipment (including ducts), an engineered HVAC system design, a supply of outside air for ventilation, humidity control, better windows, better insulation, and better air sealing. The *Designers* chapter contains best practices recommendations on the features energy-efficient homes should include. Many builders make the comment that it's not the quantity of changes that make an energy-efficient home, but the quality that is put into building the home.

Of course, it is not always easy for a site supervisor to control all aspects of a subcontractor's work. It may be necessary, especially while these best practices are new ideas, to prioritize activities and "pick your battles." In the marine climate, the top priorities are: 1) window selection and installation, 2) HVAC sizing and installation.

*"It's not hard and it's not expensive. You just need to make sure it's done right. The cost is not a big issue. It just takes a little more work. It takes a little more attention. You've got to allow the time for testing and inspection."*

Santos Alvarez, Vice-President of Operations, SummerHill Homes

## Managing Expectations

A project manager who can foster a set of shared expectations among the important players in his or her building team can successfully build efficient houses. Two goals should influence the project manager's actions at the start of the project:

- Make sure subcontractors and in-house workers understand what you want
- Eliminate the need for unknowledgeable (and often unskilled) laborers to make design decisions.

The following best practices will help meet these goals.

### INTRODUCTION

*Taking action in your community*



### HOMEOWNERS

*Shopping for value, comfort, and quality*



### MANAGERS

*Putting building science to work for your bottom line*



### MARKETERS

*Energy efficiency delivers the value that customers demand*



### SITE PLANNERS & DEVELOPERS

*Properly situated houses pay big dividends*



### DESIGNERS

*Well-crafted designs capture benefits for builders, buyers, and business*



### SITE SUPERVISORS

*Tools to help with project management*



### TRADES

*Professional tips for fast and easy installation*

### CASE STUDIES

*Bringing it all together*



## Develop a Work Plan

Decide who is going to do what. Will the plumber install insulation behind the tub or will the framer, or some other trades person? Develop a schedule for the order that activities should occur to be sure that actions are done in a reasonable order and that no actions will be forgotten. Be sure that all needed materials are on the site when the activity is scheduled to take place. More information on scheduling is included in the Managing Execution section.

## Plans – Get Them Right

**Best Practice:** Before starting a project ensure that plans are correct and that you have everything you need to go forward. Once you have the plans you need, follow them.

Existing stock plans will likely need to be modified to both include necessary changes and to add details not commonly included in residential prints. See the *Designers*  chapter for a description of design best practices.

A well-designed home should have well-designed plans that include everything necessary to explain expectations to the subcontractors. Some points that should be included are:

- **HVAC design details and duct layout.** The duct layout must be included on a floor plan. The duct and diffuser sizes, quantities, and locations must be installed as specified. Subcontractors should be contractually obligated to these specifications. Performance requirements, such as seasonal energy efficiency ratio (SEER) and annual fuel utilization efficiency (AFUE), for system components should be specified on the plans.
- **Framing plan.** A detailed plan is needed (especially if advanced framing is to be incorporated in the design) showing how framing techniques will be applied. These should detail the placement of studs to ensure proper “stacking” in two-story homes and should show details of window and door framing. The framing plan should be used to coordinate plumbing, mechanical, and electrical runs. Advanced framing is not required to achieve 30% energy savings in the marine climate but is an important money and time-saving measure for more highly efficient homes.
- **Other details or specifications.** Details and specifications should be written or drawn to specify how particular measures will be installed, including both the techniques and the materials to be used. Of particular importance are specifications and details for items that differ from local standard practice such as caulking; draft stops behind bathtubs, stairs, and dropped ceilings; duct sealing requirements; gasket materials; window schedules specifying U-factors and solar heat gain coefficients (SHGCs); and product performance metrics. Also specify items that should not be done, such as caulking ceiling penetrations under conditioned attics.

## Plans — Keep Them Right

**Best Practice:** Avoid plan changes. When they are required, document the changes as you would the original contract.

*“It is just as easy to do things right as it is to do things wrong. Once the contractors and subcontractors understand what our definition of right is, then it is not a problem [building to Building America standards].”*

Les Bluestone, owner of Blue Sea Development Company in New York

## PLANS

Make sure they are correct and follow them closely.

*“With production builders, nothing is simple, everything is challenging to roll out smoothly in a high-quality way. But there are ways to make energy-efficiency happen that are cost effective, that make sense from a dollar perspective.”*

Jeff Jacobs, Project Manager, Centex, Northern California division

## AVOID CHANGES

Thoroughly document any changes to plans.

# SITE SUPERVISORS

Numerous difficulties can be avoided with correct building plans. If the plans have been properly developed, with the proper sizing of equipment, you must be sure that changes will not undo this good work. The practice of verbally communicating changes is always risky and is potentially disastrous for a systems-designed home where high-performance features interact to achieve energy efficiency, comfort, and durability. Before making any changes ask yourself these questions:

- Why are the changes being made? If there are no clear benefits from the change, don't do it.
- What effect will the change have on building performance? Will the change deviate from best practice recommendations? Will you need to change HVAC sizing or system selection? If you don't know the answer to these questions, ask your designer, engineer, or home energy rating system (HERS) professional. Be sure to adjust all the systems related to the change.
- Are new drawings or specifications needed to clearly document your expectations? Be clear in your expectations.

## Contracts – Write Them Down

**Best Practice:** Prepare or update formal contracts with key subcontractors that clearly show what you expect of them and what they can expect from other subcontractors. Relevant details, plans, and specifications described in the last section should be referenced in the contracts. If the subcontractor is providing materials, list the specific materials that you want. Here are some examples of materials that a subcontractor may supply:

- Recessed downlights, which should be air-tight and rated for insulation contact
- Water-based mastic, to seal ducts
- High-density fiberglass insulation
- Sealants and caulks to seal penetrations
- Windows which are typically ordered along with other major purchases, but if a subcontractor is supplying them, be sure they are rated as called out in the plans
- Draft-stopping sheathing to seal large air leaks.

If you have expectations for a subcontractor, such as sealing certain types of holes, or installing insulation in some space that may become inaccessible, be sure these expectations are spelled out in the contract. The scope of work should cover things like equipment size, duct sizes, identification of who is responsible for sealing which holes, etc. The scope of work should state who is to provide what materials and when, and how materials will be stored on the construction site. Contract specifications and written assignments of responsibility can greatly simplify the ordering of materials. Duct installers, for example, will know exactly what kind of duct material will be used and how much; and with this knowledge may be able to prefabricate many of their assemblies back at the shop, rather than in the field. These pre-assembled pieces tend to be of higher quality thanks to the proximity of tools and materials and better working conditions in the shop.

The *Trades*  chapter contains instructions that you may consider incorporating into your contracts. Other sources of useful contracting tools include statements of

## WORKING WITH SUBCONTRACTORS

Always prepare formal contracts and be clear about your expectations.

# SITE SUPERVISORS

work that were developed by ConSol, one of the organizations that lead a Building America team. Here is a partial listing of statements of work, designed for California, that are available on the Web at [www.comfortwise.com/installationprotocols.shtml](http://www.comfortwise.com/installationprotocols.shtml) or at [www.thebii.org/rpsw.asp](http://www.thebii.org/rpsw.asp):

- Quality caulking and sealing
- HVAC system design and installation
- Quality installation of insulation
- Sliding door installation
- Window installation.

## Pre-Construction Meeting – Have One

**Best Practice:** A final strategy to manage expectations among the subcontractors is to hold a pre-construction meeting that includes as many of the subcontractors as possible. At this meeting you can emphasize the changes in workflow, shifts in responsibilities, and newly introduced building details. Tell your subcontractors about your goals for energy-efficient houses.

Give the subcontractors drawings and instructions on how to accomplish their jobs. Sample instructions are included in the *Trades*  chapter. This meeting will go a long way toward helping people to understand their roles and responsibilities. Make sure that your subcontractors are aware that you will be conducting inspections and that both the ductwork and the building envelope will be tested for air tightness.

It may be necessary, especially when starting your first energy-efficient homes, to hold additional training sessions with key subcontractors. More on this is discussed in the Managing Quality section below.

## Permits – Grease the Skids

A home built according to the instructions contained in this document for the marine climate does not violate any provisions of the national model codes or, usually, of local regulations. However, many local code officials are unfamiliar with some of the recommended construction techniques. It is well worth your while to raise these issues yourself before construction begins so that you're not surprised by a red tag later.

**Best Practice:** Ensuring that the “new” techniques are clearly delineated on the building plans can also help flag these issues during plan review rather than during inspection.

**Best Practice:** A meeting with the building department before construction is well-advised. Your code official may need information in support of the new techniques you may use in an energy-efficient home.

*Appendix III* contains a sample of a draft code note that may be helpful. A set of draft code notes is available on DOE's Building Energy Codes Resource Center. These draft documents are written for codes officials and provide a description of energy efficiency techniques, citations to relevant codes, and guidance for plan reviews and field inspections. The sample in *Appendix III* is the last one on the list below and is entitled *Rigid Board Insulation Installed as Draft Stop in Attic Kneewall – Code Notes (Draft)*.

## PRE-CONSTRUCTION MEETING

Include your subcontractors in pre-construction meeting to discuss changes associated with your energy efficiency goals.

## SHOW TECHNIQUES ON BUILDING PLANS

Ensure that all “new” techniques are delineated on the building plans.

## PLAN A MEETING WITH THE BUILDING DEPARTMENT

Your code official may need information about energy-efficient home techniques.

# SITE SUPERVISORS

Here is a list of available code notes that should help assure your local code official that the proposed techniques are both safe and in compliance with the model codes; the code notes are available at [www.energycodes.gov/support/code\\_notes.stm](http://www.energycodes.gov/support/code_notes.stm).

- Single top plate
- No headers in nonbearing walls
- Header hangers in bearing walls
- Framing floor joists spaced at 24 inches on center
- Framing studs spaced at 24 inches on center
- Open spaces as return-air options
- Details for mechanically vented (conditioned) crawl spaces
- Ventilation requirements for condensing clothes dryers
- Drywall clips
- Rigid board insulation installed as draft stop in attic knee wall.

## Managing Execution

If you've managed to establish clear expectations with your subcontractors and suppliers, you're almost ready to begin construction. The final parts of the plan involve training subcontractors as necessary, scheduling everything, and monitoring progress.

## Training

**Best Practice:** Attend and have your key subcontractors attend a training course on integrated system designed housing.

One good way to accomplish this may be to let your HERS provider (see Quality Assurance below) conduct the necessary training. Information on general training is available from

- Building America – [www.buildingamerica.gov](http://www.buildingamerica.gov)
- Energy and Environmental Building Association – [www.eeba.org](http://www.eeba.org)
- Building Science Corporation – [www.buildingscience.com/workshops/default.htm](http://www.buildingscience.com/workshops/default.htm)
- National Association of Home Builders Research Center – [www.nahbrc.org](http://www.nahbrc.org)
- Southface Energy Institute – [www.southface.org](http://www.southface.org)
- IBACOS – [www.ibacos.com](http://www.ibacos.com).

Other sources may include regional universities or Cooperative Extension Service programs, homebuilder associations, utilities, and codes programs. More specialized training is available at the above sources, plus trade organizations, such as:

- Air Conditioning Contractors Association – offers technician certification – [www.acca.org](http://www.acca.org)
- American Architectural Manufacturers Association – offers window installation master certification – [www.installationmastersusa.com](http://www.installationmastersusa.com).

The Web provides a free and easy method to train crews. The California Energy Commission offers on its Web site a series of brief videos, lasting only a few minutes each, that cover many installation processes. Visit [www.energyvideos.com](http://www.energyvideos.com) for access to

*“There is an education aspect both with the buyers and with the trades people. A lot of people do not really understand the real benefits of building to these Building America principles.”*

Michelle Horstemeyer, a lead builder for John Wieland Homes

## INTEGRATED SYSTEM DESIGNED HOUSING

Be sure to attend a training on systems-designed housing.



# SITE SUPERVISORS



dozens of videos. The U.S. Department of Housing and Urban Development Pathnet Web site contains videos on buildings systems and new plumbing technologies. Visit [www.pathnet.org/sp.asp?id=10787](http://www.pathnet.org/sp.asp?id=10787) to view PATH TV. PATH stands for the Partnership for Advanced Housing Technology.

## Scheduling

Constructing an energy-efficient home requires careful attention to scheduling. Several of the new construction techniques may require changing the order of subcontractors; some require (or benefit from) a shifting of responsibilities from one subcontractor to another; and some new activities will need to be added into the schedule. Here are some of the more important schedule considerations:

- Schedule HVAC rough-in before plumbing and electrical. It is far more important for the ductwork to have un-constricted access and pathways than it is for wires or pipes. But be sure needs for other systems, such as drain pitch, are coordinated.
- If using a conditioned attic, schedule insulating under the roof deck before HVAC rough-in. The insulators must be able to do their job without tromping on the carefully placed ductwork.
- Don't forget to schedule for pipe insulation under the slab.
- Be sure to schedule pre-drywall insulation inspections, flashing inspections, and envelope and duct pressure tests. Inspect at key points to ensure that insulation and envelope sealing take place before areas become inaccessible. Inspections are much more likely to happen if scheduled. And subcontractors may be a bit more conscientious if they know their work will be evaluated.
- Be sure to schedule caulking of electrical and plumbing penetrations after drywall is completed and the lines have been installed.

Some situations that may require a shifting of responsibilities include:

- If using advanced framing techniques that include two-stud corners and floating drywall corners (see the section on wall framing in the *Designers*  chapter and *Appendix III*), someone must attach drywall clips. The framer is a more likely candidate than the drywall installer for framing modifications.
- Some caulking work needs to be done by the HVAC subcontractor. In particular, main supply and return trunks that lead through walls need to be caulked by the person connecting them to the equipment. Don't let the drywall finisher do this with mud—it is neither a good sealant nor durable enough. Also, all duct terminations, including jump ducts, must be sealed when registers are installed.
- Some post-finish caulking can be avoided by having the electrician use pre-fabricated air-tight electrical boxes (see the *Trades*  chapter for an electricians tip sheet).
- If installation of windows and drainage planes are done by different subcontractors, the window installer must be careful to leave flashing unattached at the bottom so that the first row of building paper may be tucked under it (see the *Trades*  chapter tip sheets for window flashing, house wrap, and sealants).

Jeff Simon, Executive Vice President of Operations for Veridian Homes, offers this advice for builders considering Building America, *"You need to have systems in place for scheduling and documentation so you can successfully recreate the home. If you don't have good systems and good organization, it will be a challenge. You need to be willing to take a risk."*

# SITE SUPERVISORS

- If you are using insulated headers, the framer will need to install insulation inside any double headers (using sandwiched foam insulation). Open headers may be left for the insulation contractor.
- Draft stops must be installed behind bathtubs, stairwells, chases, soffits, fireplaces, and other dual framed areas on exterior framed walls. The framer should do this, but be sure that insulation is installed before the draft-stop material goes on.
- Innovative scheduling of subcontractors can bring huge rewards in reduced costs and improved quality. See our case study on Pulte Sun Lakes for more information.

## Quality Assurance

The NAHB, the U.S. Department of Housing and Urban Development, and other sources of builder technical and management information offer guidance for improving quality assurance on job sites. The following sections contain quality assurance information related to energy efficiency.

## Inspections

**Best Practice:** Conduct several inspections during the course of construction, always conduct pressure tests of both the whole house and the HVAC ductwork, and always check AC and heat pump refrigerant charging. Have the house rated by a certified HERS rater.

Especially when energy-efficient systems-designed housing is new to your subcontractors, you should conduct multiple inspections to ensure that the subcontractors have understood what is required of them and how to implement it. After the process has become more routine, you might get by with just a couple of inspections. One key inspection should occur prior to installation of drywall.

The pre-drywall inspection allows you to ensure that insulation and draftstopping have been properly installed before they get permanently enclosed. This is also the best time to conduct a pressure test on the ductwork. The duct pressure test should be conducted with the HVAC contractor present, at least for his or her first several energy-efficient homes. If the ductwork fails to meet the pressure criteria, a smoke test will reveal the worst leaks. It is crucial that this happen while the ductwork is still visible and the HVAC contractor is present to see what the problem areas are. Other commissioning activities should include duct flow testing and balancing, as well as return pressures in rooms with doors.

Duct testing services can be most easily obtained through a certified HERS rater. The rater can also conduct whole-house pressure tests and assist with training. And the HERS Index itself can be a valuable marketing tool for an energy-efficient house. To identify a certified rater in your area, check the registry at the Residential Energy Services Network (RESNET) Web site: [www.natresnet.org](http://www.natresnet.org).

The second important inspection comes after completion of the home, including all interior and exterior finishes. This pre-occupancy inspection should check for proper sealing of electrical and plumbing (fixtures and drywall penetrations), HVAC registers, and the HVAC closet. A whole-house air leakage test (aka “blower-door” test) is crucial. Again, your HERS provider is the easiest resource for this service, and this is

*“Building America is a way to manage risk, potential litigation issues, and building systems failures.”*

Josh Robinson, Pulte Sun Lakes project manager and a Pulte Vice President

## INSPECTIONS

Conduct inspections throughout the construction process.

# SITE SUPERVISORS

when he or she would be rating the home anyway. Also, if your HVAC contractor has not done it, a final check of the AC or heat pump refrigerant charge is crucial. Studies have shown that failure to check refrigerant charging results in the average system using 13% too much energy (<http://hem.dis.anl.gov/eehem/00/001105.html>).

## Energy Efficiency Checklists

A successful energy-efficient building involves many details. It is worthwhile to maintain for each house a checklist of important features to keep track of what has been done. Although the best checklist is one you've made specific to the design(s) you are implementing, the three checklists on the following pages are a good baseline to work from and may be integrated with your existing checklists.

---

### SPOT-CHECK INSPECTION CHECKLIST

These items should be checked if possible as they are installed because they may not be accessible at the pre-drywall inspection.

- Grading is sloped at 5% away from the house for at least 10 feet. Roof drainage is directed at least 3 feet beyond the building.
- A 6-mil polyethylene sheet is installed directly beneath the concrete slab, continuously wrapping the slab and the grade beam.
- Roof materials are installed to provide a continuous drainage plane over the entire surface of the roof. Wall/roof junctures should be appropriately flashed, including kick-out flashing at the bottom.
- HVAC system is appropriately sized and installed according to plans. No deviations should be made in the field.
- A mechanical ventilation system is installed as specified in the plans.
- Each bedroom has a separate HVAC return duct, a transfer grille, or a jump duct.

# SITE SUPERVISORS

## PRE-DRYWALL INSPECTION CHECKLIST

*Note:* Some measures in this list are unnecessary depending on whether the house is sealed on the interior (e.g., air-tight drywall) or exterior (e.g., sheathing) of the wall.

- Bathtubs on exterior walls have insulation behind them and draftstops installed.
- Dropped ceilings, dropped-soffit cabinets, and stairwells on exterior walls have draftstops installed behind them (unless drywall was installed prior to framing-in).
- Windows and doors are sealed to framing using caulks, foams, backer rod, and/or similar.
- Window flashing is properly installed to shed water.
- All electrical and plumbing penetrations between conditioned and unconditioned spaces are caulked or otherwise sealed.
- All recessed lights beneath unconditioned spaces are air-tight and rated for insulated ceiling (IC). All kitchen and bathroom fans are appropriately rated (capacity and sound) and exhausted to the outside.
- All exterior penetrations (exterior light fixtures, phone and other service cables, etc.) are sealed with caulk, gaskets, or similar.
- All housewrap seams are overlapped and taped; top and bottom edges are sealed past the plates; housewrap is appropriately lapped under window flashing.
- Building paper seams are overlapped shingle style to shed water and appropriately lapped under window flashing.
- Batt insulation is kraft-faced or blown-in insulation or spray foam is used.
- Unless specifically required by code, no polyethylene vapor retarder is installed on the inside of the walls.
- Ductwork is sufficiently air-sealed as verified by a duct pressure test conducted by a HERS rater or other qualified building scientist. Ductwork leakage to the exterior should be not more than 5% of the total air handling unit capacity (at high speed) when tested at 25 Pa pressure.

# SITE SUPERVISORS

## PRE-OCCUPANCY INSPECTION CHECKLIST

- Entry of main supply/return ducts into air handling unit closet is appropriately sealed with foam, caulk, or similar materials (NOT with drywall mud).
- Plumbing penetrations are air sealed.
- Electrical switch and outlet boxes are sealed to drywall with caulk or gaskets.
- Light fixture boxes are sealed to drywall with caulk or gaskets.
- Bathroom and kitchen fans are sealed to drywall with caulk or gaskets.
- Bathroom and kitchen fans are drawing air-tested with a small piece of tissue; the fan should hold the paper against the grille.
- Duct boots/registers are sealed to floor or drywall with caulk or gaskets.
- Attic hatches and kneewall entries are weatherstripped and insulated.
- Refrigerant charge on air-conditioner/heat pump is verified in writing by installer to be within specs, using superheat method for non-Thermostatic Expansion Valve (TXV) systems or subcooling method for TXV systems; this may require a return visit during warm weather.
- The whole-house envelope is sufficiently air-sealed as verified by a whole-house pressure test. Air leakage should be tested by a HERS rater and should be less than:
  - 2.5 in.<sup>2</sup> per 100 ft<sup>2</sup> of envelope area (Canadian General Standards Board (CGSB), calculated at a 10-Pa pressure differential), or
  - 1.25 in.<sup>2</sup> per 100 ft<sup>2</sup> of envelope area (American Society for Testing and Materials [ASTM], calculated at a 4-Pa pressure differential), or
  - 0.25 CFM/ft<sup>2</sup> of envelope area when tested at a 50-Pa pressure differential.

# SITE SUPERVISORS

## Sources & Additional Information

*(See Appendix V for more information on Web sites.)*

- [www.acca.com](http://www.acca.com)
- [www.buildingamerica.gov](http://www.buildingamerica.gov)
- [www.buildingscience.com/workshops/default.htm](http://www.buildingscience.com/workshops/default.htm)
- [www.buildiq.com](http://www.buildiq.com)
- [www.comfortwise.com/installationprotocols.shtml](http://www.comfortwise.com/installationprotocols.shtml)
- [www.eeba.org](http://www.eeba.org)
- [www.energycodes.gov/support/code\\_notes.stm](http://www.energycodes.gov/support/code_notes.stm)
- [www.energyvideos.com](http://www.energyvideos.com)
- <http://hem.dis.anl.gov/eehem/00/001105.html>
- [www.ibacos.com](http://www.ibacos.com)
- [www.installationmastersusa.com](http://www.installationmastersusa.com)
- [www.nahbrc.org](http://www.nahbrc.org)
- [www.natresnet.org](http://www.natresnet.org)
- [www.pathnet.org/sp.asp?id=10787](http://www.pathnet.org/sp.asp?id=10787)
- [www.southface.org](http://www.southface.org)
- [www.thebii.org/rpsw.asp](http://www.thebii.org/rpsw.asp)



# TRADES

## *Professional tips for fast and easy installation*

On the following pages you will find step-by-step, easy-to-follow illustrated instructions for implementing key energy efficiency technologies.

These *Building Tips* are designed to be easily duplicated and distributed.

- Slab Insulation - Marine Climate
- Basement & Conditioned (Unvented) Crawlspace Insulation
- Housewrap
- Window Flashing
- Air Sealing - Plumbing
- Air Sealing - Electrical
- Air Sealing - Drywall
- Air Sealing - Glossary
- Fiberglass Insulation
- Masonry Construction
- Radiant Barriers
- Duct Sealing

### INTRODUCTION

*Taking action in your community*



#### HOMEOWNERS

*Shopping for value, comfort, and quality*



#### MANAGERS

*Putting building science to work for your bottom line*



#### MARKETERS

*Energy efficiency delivers the value that customers demand*



#### SITE PLANNERS & DEVELOPERS

*Properly situated houses pay big dividends*



#### DESIGNERS

*Well-crafted designs capture benefits for builders, buyers, and business*



#### SITE SUPERVISORS

*Tools to help with project management*



#### TRADES

*Professional tips for fast and easy installation*

### CASE STUDIES

*Bringing it all together*





# SLAB INSULATION

## MARINE CLIMATE

### Building Tips

\* Slab insulation may not be needed to reach energy efficiency targets of these best practices

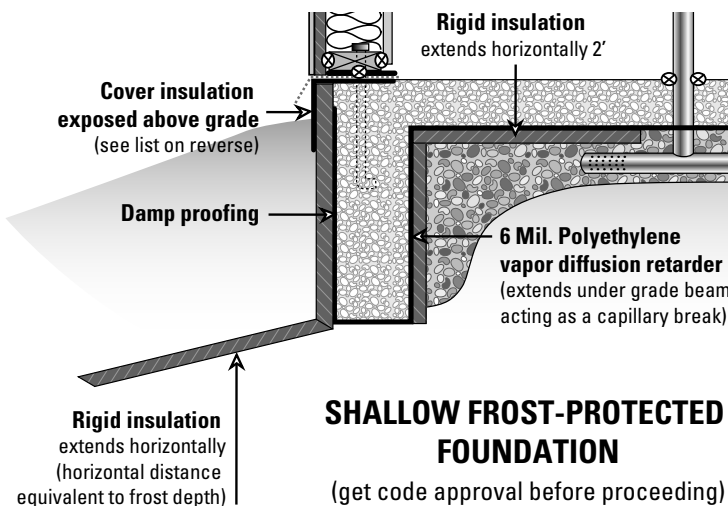
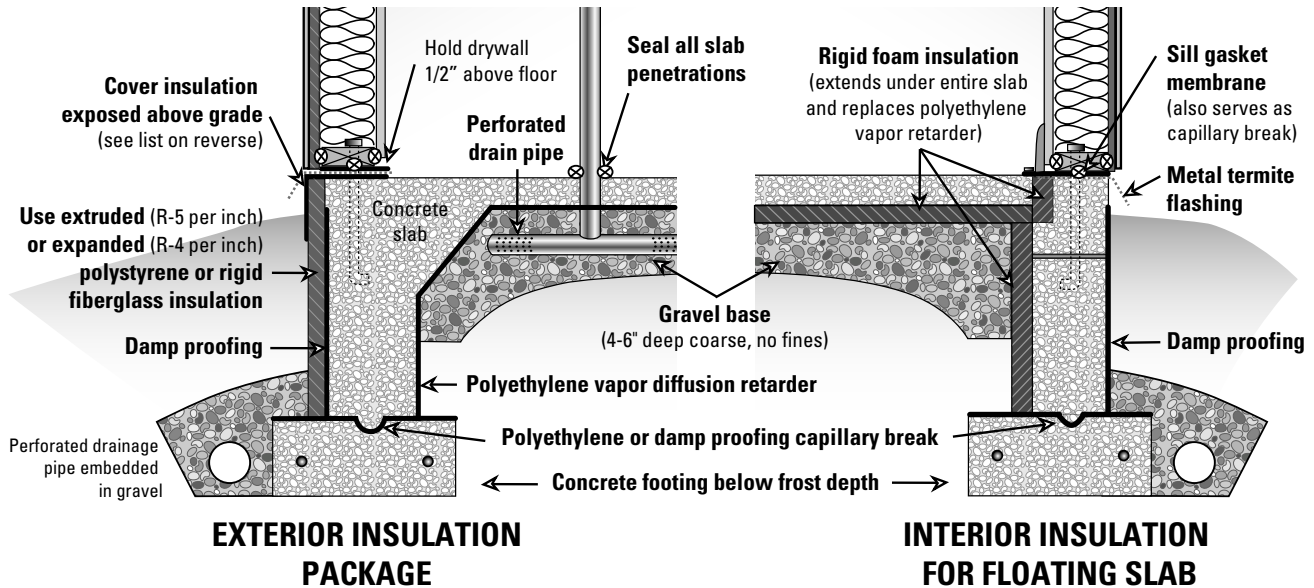
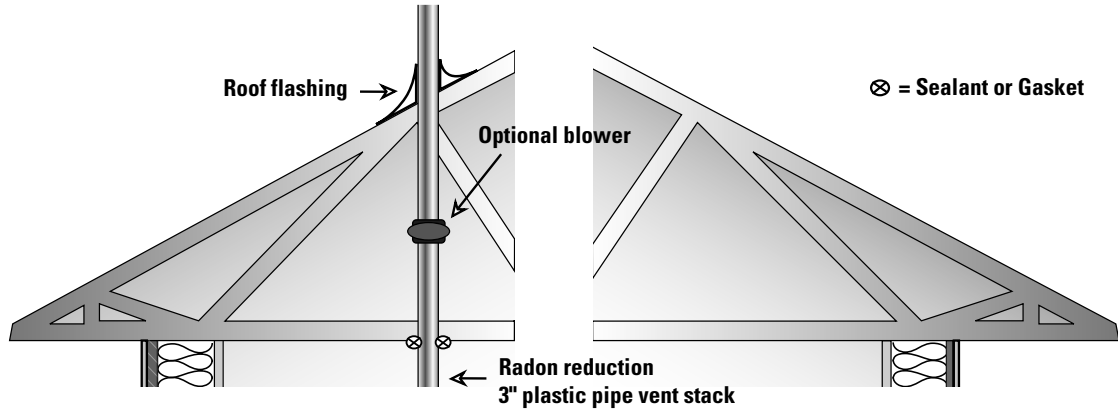

See more information on the following page.



## Slab Foundation System Moisture and Air Leakage Control

- Keep all untreated wood materials away from contact with earth and concrete.
- Design the house structure with overhangs, gutters, drainage planes, and flashing to shed rainwater and conduct it away from the house.
- Slope the earth away from the house and ensure that no irrigation strikes near the foundation.
- Use a sill gasket for air sealing
- Install a protective shield such as metal flashing, plastic L bracket, or a membrane (such as EPDM flexible roofing material\*) to block capillary water wicking into the wall from the foundation. The protective shield may also serve as a termite shield.
- Slabs require a foundation drain where the slab (or floor) is located below grade. Install a foundation drain alongside the footing (not above it). The drain should rest in a bed of coarse gravel (no fines) that slopes away from the foundation and is covered with filter fabric.
- Exterior rigid fiberglass insulation may provide a drainage plane that will channel water to the foundation drain and relieve hydrostatic pressure.
- Exterior foundation wall insulation requires a protective coating at above-grade applications. Examples of protective coverings for exterior, above-grade insulation include flashing, fiber-cement board, parging (stucco type material), treated plywood, or membrane material (EPDM\* flexible roofing).
- Note that some code jurisdictions may require a gap between exterior insulation and wood foundation elements to provide a termite inspection area.
- Install damp proofing or a polyethylene sheet over the footing to block capillary water wicking into the foundation side wall.
- Install a capillary break and vapor retarder under the entire slab consisting of at least a 6-mil polyethylene sheet or continuous rigid foam insulation approved for below grade applications, on top of 4 to 6 inches of coarse gravel.
- Install radon control measures (check local requirements and EPA recommendations).

\*EPDM stands for Ethylene Propylene Diene Monomer.

## Sources & Additional Information

- U.S. DOE, *Technology Fact Sheet on Slab Insulation* ([www.eere.energy.gov/buildings/documents/pdfs/29237.pdf](http://www.eere.energy.gov/buildings/documents/pdfs/29237.pdf)).
- U.S. EPA, *Building Radon Out: A Step-By-Step Guide on How to Build Radon Resistant Homes* ([www.epa.gov/199/iaq/radon](http://www.epa.gov/199/iaq/radon)).
- Southface Energy Institute. *Fact Sheets #29: Insulating Foundation and Doors* ([www.southface.org/home/sfpubs/techshts/29\\_insulatefloors4PDF.pdf](http://www.southface.org/home/sfpubs/techshts/29_insulatefloors4PDF.pdf)).
- Southface Energy Institute. *Fact Sheets #30: Radon-Resistant Construction for Builders* ([www.southface.org/home/sfpubs/techshts/30\\_radonresistantconst.pdf](http://www.southface.org/home/sfpubs/techshts/30_radonresistantconst.pdf)).
- Building Science Consortium. *Introduction to Building Systems Performance: Houses that Work II*. [www.buildingscience.gov](http://www.buildingscience.gov)



# BASEMENT & CONDITIONED (UNVENTED) CRAWLSPACE INSULATION

## Building Tips

### EXTERIOR CRAWLSPACE INSULATION

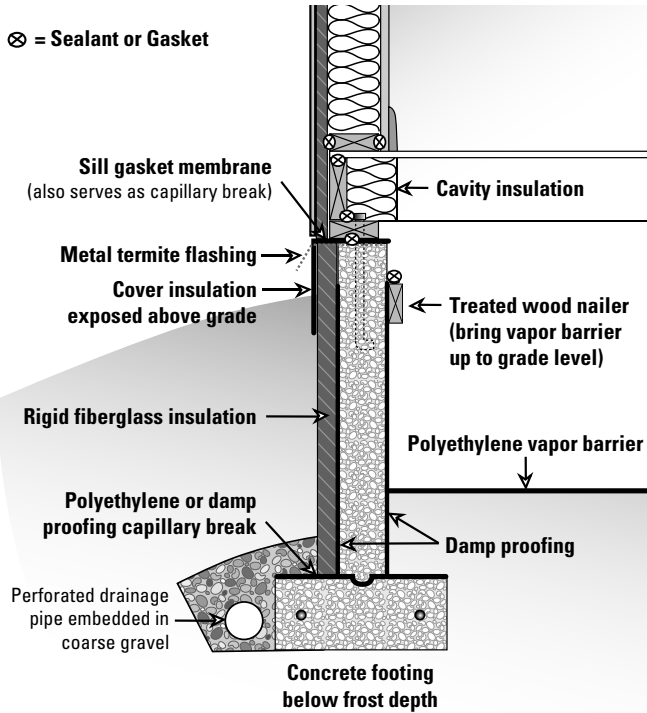

### INTERIOR CRAWLSPACE INSULATION

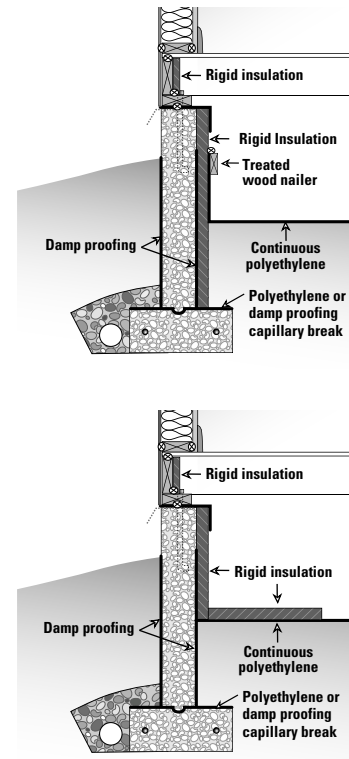

### EXTERIOR BASEMENT INSULATION

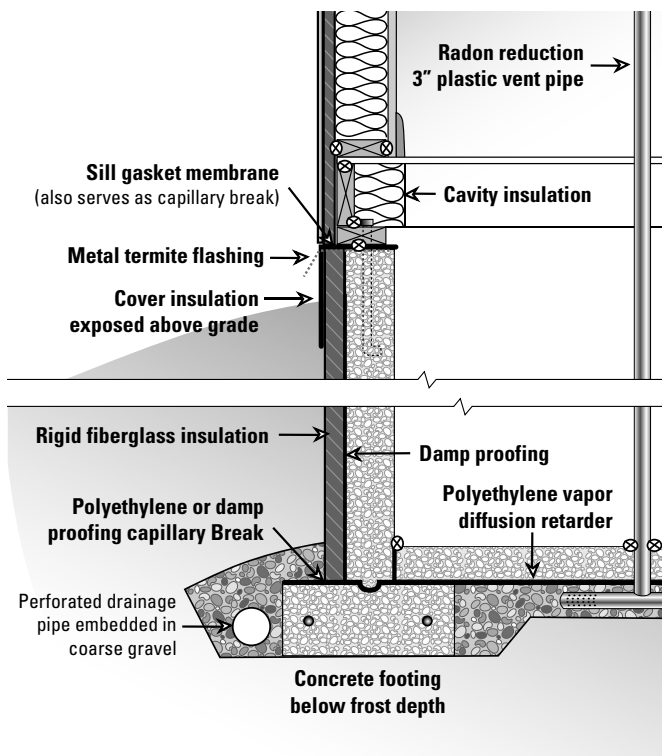

If depth does not extend two feet below grade, place remaining insulation horizontally along the ground.

### INTERIOR BASEMENT INSULATION

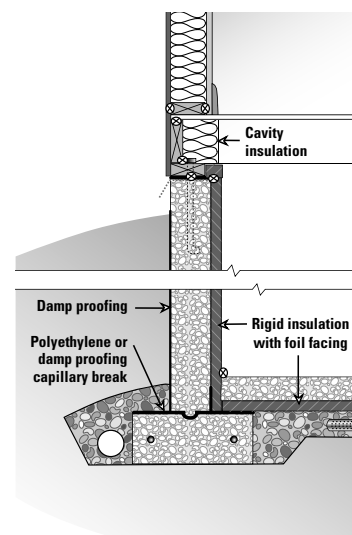

See more information on the following page.

## Installation Tips

- Exterior and interior insulation approaches may be combined to provide needed insulation levels.
- Properly installed exterior rigid fiberglass insulation provides the best moisture management properties of the available insulation types.
- Interior nailing strips for finished walls should be installed over rigid foam (extruded polystyrene is more moisture tolerant than expanded polystyrene) insulation so that the foam is sandwiched between the nailing strip and the basement wall.
- Seal joints with adhesive or mastic on interior foam insulation applied directly to foundation walls.
- If interior blanket or batt insulation is used, it should be combined with exterior or interior rigid insulation attached directly to the foundation wall. The blanket or batt insulation should be unfaced or have a facing that allows moisture to pass through, and should be used in a conditioned basement. The drywall should be tightly air sealed to keep interior moist air from condensing on the foundation wall.
- Foil-faced rigid insulation is a good interior insulation choice for unfinished basements.

## Crawlspace and Basement Foundation System Moisture and Air Leakage Control

- Keep all untreated wood materials away from contact with earth and concrete.
- Design the house structure with overhangs, gutters, drainage planes, and flashing to shed rainwater and conduct it away from the house.
- Slope the earth away from the house and ensure that no irrigation strikes near the foundation.
- Damp-proof all below grade portions of the exterior foundation wall to prevent the absorption of ground water.
- Use a sill gasket for air sealing
- Install a protective shield such as metal flashing, plastic L bracket, or a membrane (such as EPDM flexible roofing material\*) to block capillary water wicking into the wall from the foundation. The protective shield may also serve as a termite shield.
- Crawlspaces require a foundation drain when the crawlspace floor is located below grade. Always install a foundation drain in basements. Install a foundation drain alongside the footing (not above it). The drain should rest in a bed of coarse gravel (no fines) that slopes away from the foundation and is covered with filter fabric.
- Exterior rigid fiberglass insulation may provide a drainage plane that will channel water to the foundation drain and relieve hydrostatic pressure.
- Exterior foundation wall insulation requires a protective coating at above-grade applications. Examples of protective coverings for exterior, above-grade insulation include flashing, fiber-cement board, parging (stucco type material), treated plywood, or membrane material (EPDM\* flexible roofing).
- Note that some code jurisdictions may require a gap between exterior insulation and wood foundation elements to provide a termite inspection area.
- Install damp proofing or a polyethylene sheet over the footing to block capillary water wicking into the foundation side wall.
- Install a capillary break and vapor retarder under slabs and basement floors consisting of at least a 6-mil polyethylene sheet or continuous rigid foam insulation approved for below grade applications, on top of 4 to 6 inches of coarse gravel.
- Install radon control measures (check local requirements and EPA recommendations).

\*EPDM stands for Ethylene Propylene Diene Monomer.

## Sources & Additional Information

- IBACOS. 2002. *Consider the Crawlspace* ([www.buildingamerica.gov](http://www.buildingamerica.gov))
- IBACOS. 2002. *Don't Forget About the Basement* ([www.buildingamerica.gov](http://www.buildingamerica.gov))
- Lstiburek, Joseph. 2004. *Builders Guide to Cold Climates* ([www.eeba.org/bookstore](http://www.eeba.org/bookstore))
- U.S. DOE, *Technology Fact Sheet: Basement Insulation* ([www.buildingamerica.gov](http://www.buildingamerica.gov))
- U.S. DOE, *Technology Fact Sheet: Crawlspace Insulation* ([www.buildingamerica.gov](http://www.buildingamerica.gov))
- U.S. EPA, *Building Radon Out: A Step-By-Step Guide on How to Build Radon Resistent Homes* ([www.epa.gov/1999/iaq/radon](http://www.epa.gov/1999/iaq/radon))
- Yost and Lstiburek. 2002. *Basement Insulation Systems* ([www.buildingamerica.gov](http://www.buildingamerica.gov))



## Building Tips

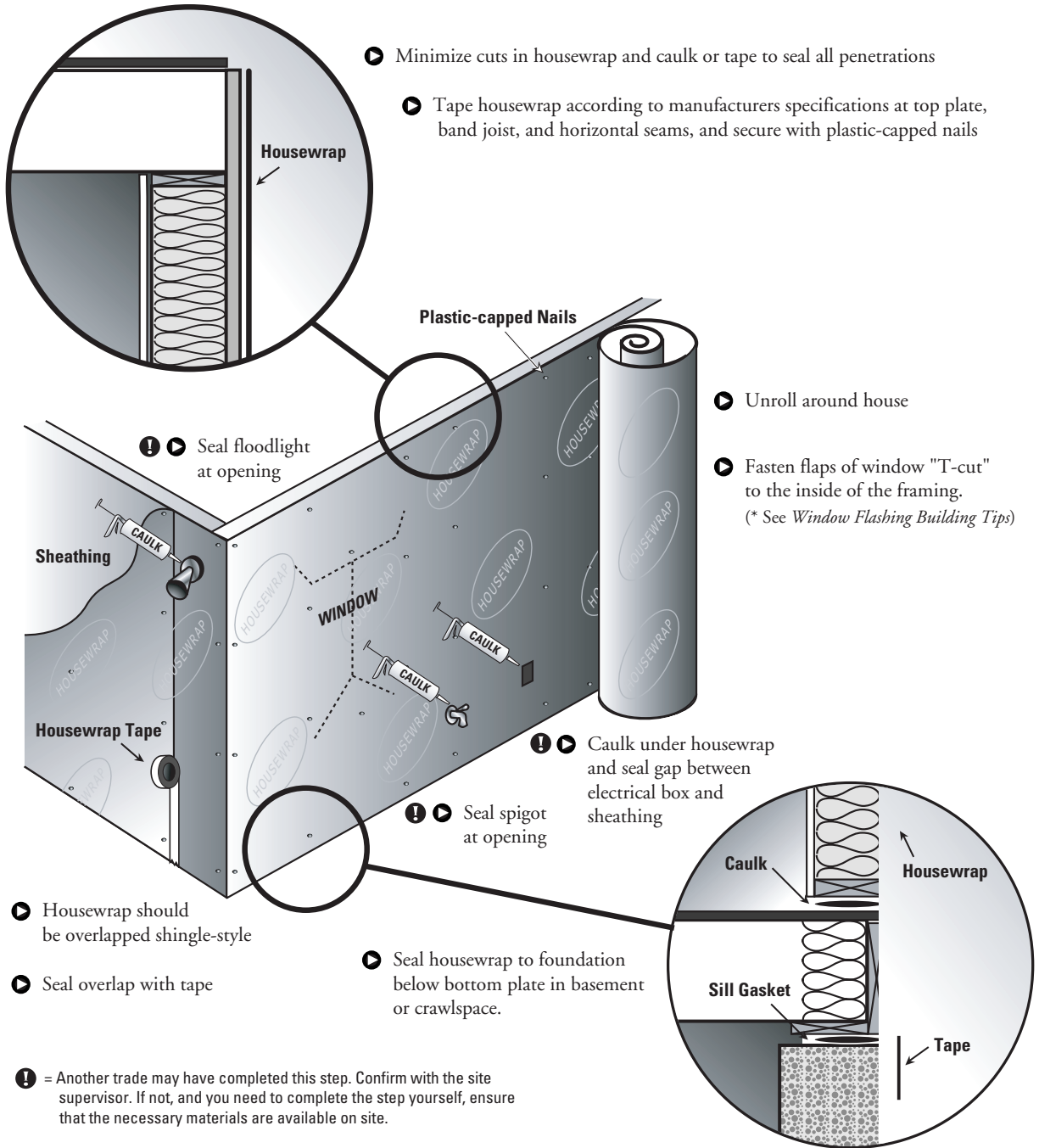

### Sources & Additional Information

- Southface Energy Institute. *Fact Sheets #8 Air Sealing* ([www.southface.org/home/sfpubs/techshts/8\\_airsealing.pdf](http://www.southface.org/home/sfpubs/techshts/8_airsealing.pdf))
- U.S. DOE. *Technology Fact Sheet on Air Sealing* ([www.eere.energy.gov/buildings/documents/pdfs/26448.pdf](http://www.eere.energy.gov/buildings/documents/pdfs/26448.pdf)).
- See also the Building Tips on *Air Sealing* and *Window Flashing*
- See: <http://construction.tyvek.com/en/productServices/HomeWrap/index.shtml>
- Straube, John. 2001. *Canadian Architect*. "Wrapping it Up". May, 2001. [www.cdnarchitect.com](http://www.cdnarchitect.com).



# WINDOW FLASHING

## Building Tips

Example of window flashing details for home with housewrap and plywood or OSB wall sheathing.

### STEP 1 - IF HOUSEWRAP HAS NOT BEEN INSTALLED

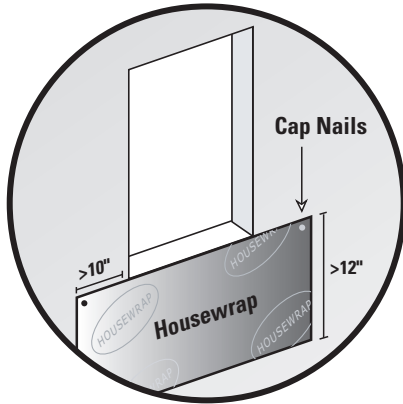

- ▶ Apply at least a 12-inch flap, or apron, of building paper or housewrap just below the window sill.
- ▶ If the window sill is close to the sill plate, the apron can extend all the way to the sill plate.
- ▶ The apron should extend at least 10 inches past the sides of the window opening, or to the first stud in open wall construction.
- ▶ Attach only the apron's top edge with cap nails.

### STEP 2 - SILL FLASHING

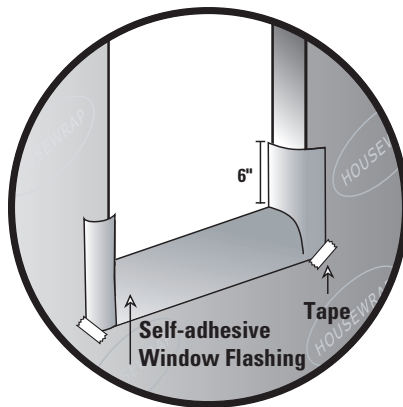

- ▶ Install self-adhesive flashing to the sill, ensuring that flashing extends up jamb at least 6 inches.
- ▶ One commercial product comes with two removable strips over the adhesive. Remove the first strip to expose half the adhesive and apply this area to the sill. Begin pressing in the middle of the sill and work towards the sides. Remove the second strip to expose the adhesive that will be used to apply the flashing below the window to the outside wall.
- ▶ Tape down the bottom corners of the flashing

### STEP 1 - IF HOUSEWRAP HAS BEEN INSTALLED

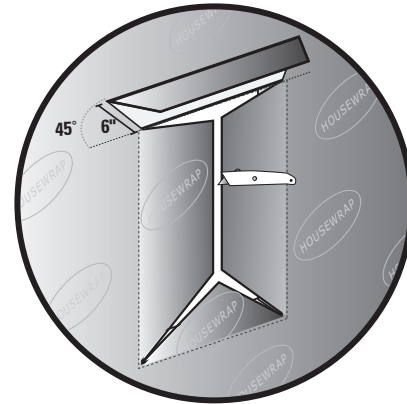

- ▶ Cut the housewrap covering the rough opening in the shape of a modified "Y."
- ▶ Fold the side and bottom flaps into the window opening and secure.
- ▶ Above the window opening, cut a head flap and flip up to expose sheathing, and loosely tape in place out of the way.

### STEP 3 - JAMB CAULKING

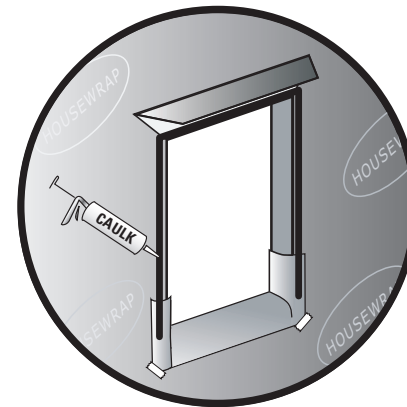

- ▶ Caulk the outside edges of the head and side jambs
- ▶ Do not caulk across the sill
- ▶ Install the window using corrosion-resistant nails and following manufacturer's specifications.

# BUILDING TIPS: WINDOW FLASHING

## STEP 4 - JAMB AND HEAD FLASHING

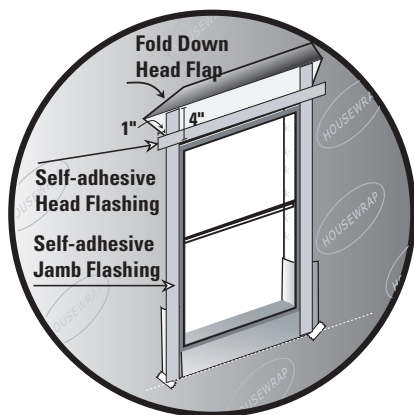

- ▶ Install self-adhesive jamb flashing extending 4 inches above the top of the head flange and even with the bottom of the sill flashing.
- ▶ Install self-adhesive head flashing extending 1 inch beyond the jamb flashing.
- ▶ If housewrap has been installed, be sure that the head flap, when it is folded down, will cover the top of the flashing.

## STEP 5 - SEAL ROUGH OPENING GAP

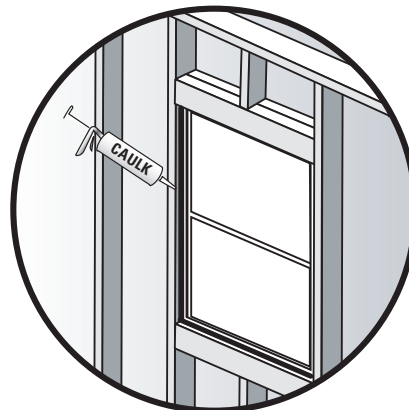

- ▶ On the interior side of the window, seal gap between the window and the rough opening with appropriate sealant.

## STEP 6 - IF APRON WAS INSTALLED



- ▶ If an apron was installed under the window, slip the housewrap or building paper under the apron.
- ▶ Tape the edges where the housewrap meets the window flange if housewrap is installed after flashing.
- ▶ If building paper is used, embed the edges in a bead of sealant where the paper meets the window flange.

## STEP 6 - IF HEAD FLAP WAS CREATED

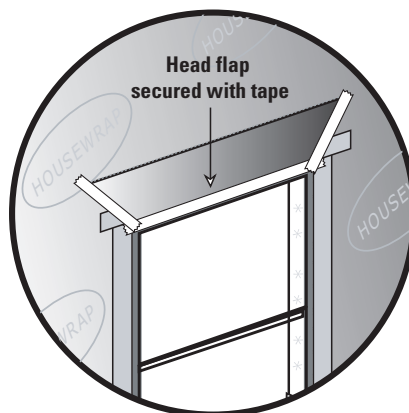

- ▶ If headflap was created, fold it over the head flashing and tape across the top window flange and the 45° angle seams.

## Sources & Additional Information

- Lstiburek, J.W. (2002). *Water Management Guide*. Minneapolis, MN: Energy and Environmental Building Association ([www.eeba.org](http://www.eeba.org)).
- U.S. DOE *Technology Fact Sheet on Weather-Resistive Barriers* ([www.eere.energy.gov/buildings/documents/pdfs/28600.pdf](http://www.eere.energy.gov/buildings/documents/pdfs/28600.pdf)).
- *Standard Practice for Installation of Exterior Windows, Doors, and Skylights*. ASTM E2112-01, September 2002. West Conshohocken, PA.
- [www.ibacos.com/ghome/Jan03/jan03\\_windows.html](http://www.ibacos.com/ghome/Jan03/jan03_windows.html)



## Building Tips

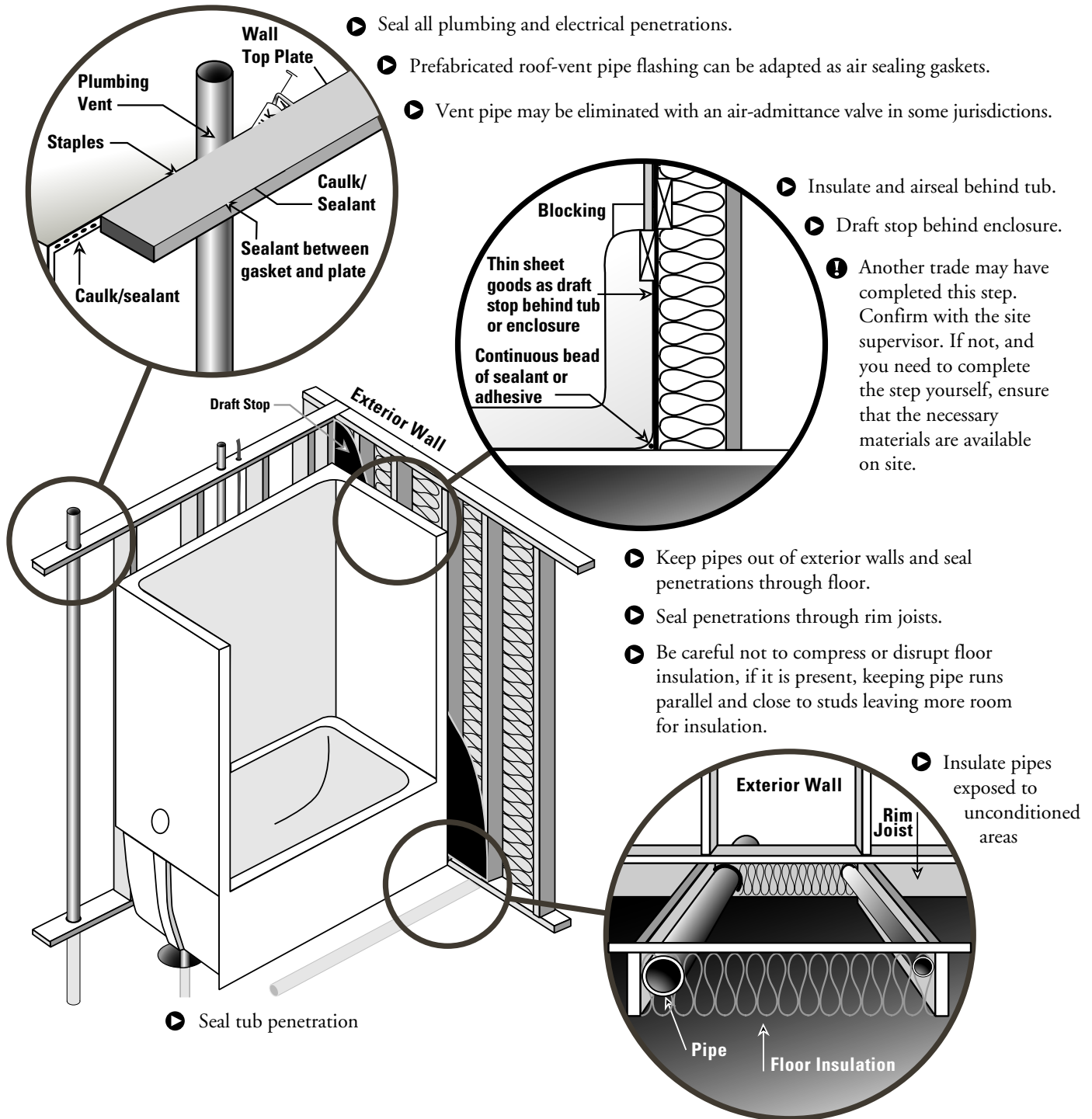

### Sources & Additional Information

- Lstiburek, J. W. 2000. *Builders Guides*. Minneapolis, MN. Energy and Environmental Building Association. [www.eeba.org](http://www.eeba.org).
- U.S. DOE *Technology Fact Sheet on Air Sealing* ([www.eere.energy.gov/buildings/documents/pdfs/26448.pdf](http://www.eere.energy.gov/buildings/documents/pdfs/26448.pdf)).
- [www.toolbase.org](http://www.toolbase.org): click on *New Building Technology* > *Plumbing* > *Distribution Systems* > *Air Admittance Vents*



## Building Tips

- ▶ Recessed light fixtures should be rated for Insulated Ceiling Air Tight (ICAT).
- ▶ Ceiling fans should be wired to a wall switch.
- ▶ Seal light fixture boxes to drywall with caulk or foam.
- ▶ Seal bath fan box to drywall with caulk or foam.
- ▶ Seal all exterior penetrations, such as porch light fixtures, phone, security, cable and electric service holes, with caulk, spray foam, or gaskets - note that foam degrades in sunlight.
- ▶ Use air-tight outlet boxes or seal standard boxes.
- ▶ Run wiring along side of stud at exterior wall and along plates
- ▶ Seal standard plastic electrical box at face to drywall with joint compound or cover the plate gasket with caulked foam.
- ▶ Caulk/seal/foam all electrical wires penetrating top and bottom plates of exterior walls.
- ▶ Run wiring along bottom plate at exterior wall.  
*NOTE: Some codes require wires to be held up from bottom plates 6"-8" to protect from future drilling through plates.*

### Sources & Additional Information

- Lstiburek, J.W. 2000. *Builder Guide Hot-Humid Climates*. Minneapolis, MN: Energy and Environmental Building Association ([www.eeba.org](http://www.eeba.org)).
- U.S. DOE. *Technology Fact Sheet on Air Sealing* ([www.eere.energy.gov/buildings/documents/pdfs/26448.pdf](http://www.eere.energy.gov/buildings/documents/pdfs/26448.pdf)).
- See also *Air Sealing Building Tips* in the chapter.





# AIR SEALING DRYWALL

## Building Tips

### MEASURE

*\*Actual assignments to be made by site supervisor. The supervisor may choose to work with a sealing specialist instead.*

	FRAMER	ELECTRICIAN	DRYWALLER	PLUMBER	WINDOW INSTALLER
<b>EXTERIOR WALLS</b>					
Install gaskets or caulk at top and bottom plates of exterior walls.	●				
Seal between the bottom plate and subflooring.	●				
Install gaskets behind coverplates.		●	●		
Seal large holes behind bathtubs or stairs with sheathing.			●	●	
<b>PARTITION WALLS</b>					
Seal the drywall at the intersection with the top or bottom plate.			●		
Seal penetrations through the top and bottom plates for plumbing, wiring, and ducts using fire-resistant sealants.		●		●	
Knee walls can be insulated and sealed at either the roofline or along the line formed by the roof, wall, and floor. Rigid foam insulation, taped at the seams with housewrap tape, can be used to seal the backside of the knee wall and the underside of the roof. Sealing along the roofline is preferred in new construction.	●		●		
<b>WINDOWS &amp; DOORS</b>					
Caulk or glue drywall edges to either framing or jambs.			●		
Fill rough opening with foam backer rod and caulk (preferred) or low-expanding foam sealant.			●		
Caulk window and door trim to drywall with clear or paintable sealant.			●		●
<b>CEILING</b>					
Seal the junction between the ceiling and walls.			●		
Whenever possible, use continuous drywall sheets for the ceiling and walls to minimize joints to be sealed.			●		
Seal all penetrations in the ceiling for wiring, plumbing, ducts, and attic access openings.		●	●	●	



## *Building Tips*

### **Caulk**

Seals gaps of less than 1/2 inch. Select grade (interior, exterior, high temperature) based on application.

### **Expanding Spray Foam**

Fills large cracks and small holes. Expanding foams are messy but useful for filling large holes or cracks. The material expands 2 to 3 times in volume after application. It comes in one-part cans that require no mixing or in two-part systems for larger jobs. It degrades in sunlight and users should be careful not to get the foam on their skin. **DO NOT USE** near flammable applications (e.g., flue vents). **DO NOT USE** on windows and doors. In large applications, a two-part system is used, which involves mixing the sealant on site. For small jobs, one-part spray cans are used.

### **Low-Expanding/Non-Expanding Spray Foam**

These latex-based spray foams come in one-part spray cans. They expand very little or not at all and will not pinch jambs or void window treatments.

### **Backer Rod**

Closed-cell foam or rope caulk. Press into crack or gap with screwdriver or putty knife. Often used with caulk around window and door rough openings.

### **Gaskets**

Apply under the bottom plate before an exterior wall is raised or use to seal drywall to framing instead of caulk or adhesive.

### **Housewrap**

Installed over exterior sheathing. Must be sealed with housewrap tape or caulk to act as an air retarder. Resists water, but is **NOT** a vapor barrier.

### **Sheet Goods**

(Plywood, Drywall, Rigid Foam Insulation) These materials form an air retarder. Air leaks only at unsealed seams or penetrations.

### **Sheet Metal**

Used with high-temperature caulk for sealing high-temperature components, such as flues, chimneys, and framing.

### **Polyethylene Plastic**

This inexpensive material for air sealing also stops vapor diffusion. All edges and penetrations must be completely sealed for an effective air retarder. Poly is fragile, and proper placement is climate specific.

### **Weatherstripping**

Used to seal moveable components, such as doors, windows, and attic accesses.

### **Mastic**

A thick paste that can be used on all duct materials that provides a permanent seal. Seals air handlers and all duct connections and joints. UL-181-approved water-based mastic is best.

### **UL-181 or Foil-Faced Tape**

Tapes approved for ducts and air handlers. Temporarily seals the air handler.

---

## **Sources & Additional Information**

- U.S. DOE. *Technology Fact Sheet on Air Sealing* ([www.eere.energy.gov/buildings/documents/pdfs/26448.pdf](http://www.eere.energy.gov/buildings/documents/pdfs/26448.pdf)).



## Building Tips

### INSTALLING FIBERGLASS BATT INSULATION

#### ALWAYS:

- Avoid gaps, tight turns, and compression
  - Cut insulation to fit snugly in non-standard spaces.
  - Slit batts to fit around wiring and plumbing.
  - Notch out around electrical boxes and use scraps to fill in behind.
- Install long runs first – then use scraps to fill in smaller spaces and gaps.
- Use unfaced batts in hot and humid climates.
- Even if blown-in insulation is to be generally applied, use fiberglass batts to insulate areas that will be inaccessible to the blown-in insulation, such as behind bath enclosures.

#### Walls:

- Friction-fit the batts in place until covered by drywall or sheathing.
- Insulate before installing stairs and tubs and other features that will block access.

#### Knee Walls:

- Seal knee wall to create a continuous air barrier. Knee walls can be sealed following the wall itself and attic floor or along the sloping edge of the attic roof. Rigid foam insulation, taped at the seams with housewrap tape, can be used to seal the backside of the kneewall and the underside of the roof. Sealing along the roofline is preferred in new construction.
- Insulate and air seal the rafter space along the sloping ceiling of the knee wall attic space or insulate and air seal the roofline wall and floor.
- Rafters should receive R-19 or R-30 insulation.
- Cover rafters with a sealed air barrier (such as drywall or foil-faced hardboard).
- Caulk the barrier to the top plate of the wall below the attic space and to the top plate of the knee wall itself.
- Seal all other cracks and holes.

#### Ceilings:

- Insulate and seal the attic access door
- Install insulation over ICAT-rated recessed cans.
- Verify ventilation pathways.
- Install insulation baffles.

#### Band Joists:

- Place insulation in the cavities between joists and subfloor.
- Caulk bottom plate to subfloor.
- Caulk band joist to subfloor and plates and insulate.
- Caulk bottom plate to subfloor.

#### Under Floor Insulation:

- Metal stays, lathe, or stainless steel wire support insulation in joist cavities.
- In new construction it is preferred that crawlspace walls are insulated. If underfloor insulation is to be used, it can be held in place with metal staves, lathe, stainless steel wire, or twine.
- If truss systems are used under floors, an approach better than batt insulation is to install netting or rigid insulation to the underside of the floor trusses and fill the joist cavity with blown-in insulation.

#### Sources & Additional Information

- Energy Efficient Building Association's *Builder's Guide Hot-Humid Climates*, 2000.
- U.S. DOE *Technology Fact Sheet on Attic Access*.
- U.S. DOE *Technology Fact Sheet on Crawlspace Insulation*.
- \* Refer to the *Air Sealing Building Tips* in this chapter



## Building Tips

- ▶ Semi-vapor permeable rigid insulations used on the interior of wall assemblies should be unfaced or faced with permeable skins. Foil facings and polypropylene skins should be avoided.
- ▶ Wood furring should be installed over rigid insulation; the rigid insulation should be continuous over the surface of the wall, except for the 2x4 furring near the ceiling. This blocking attaches directly to the masonry block and is above the insulation, not behind it.

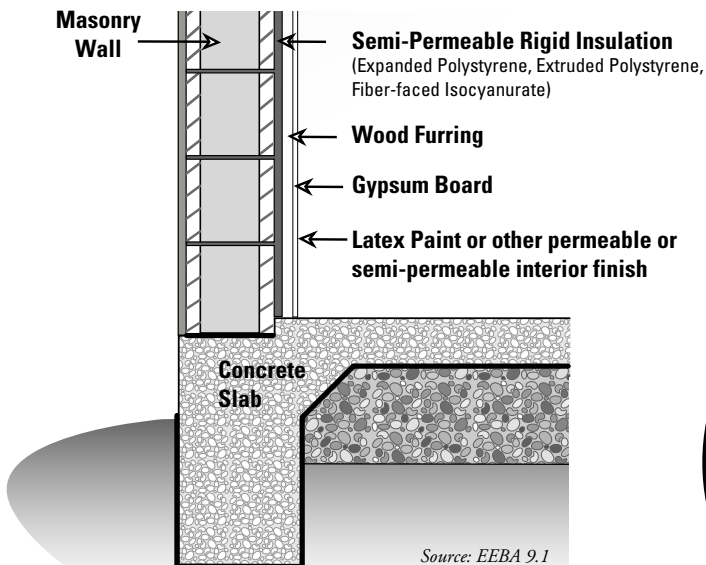
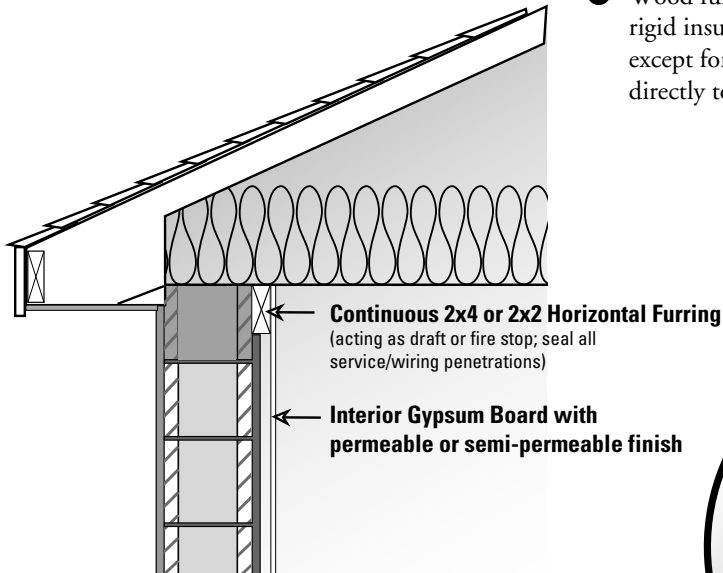

- ▶ Electrical boxes can be surface-mounted eliminating chiseling/chipping masonry

### WINDOW SILL DRAINAGE

#### Wood Sub-Jamb

(Positioned Toward Wall Exterior So That Face Of Interior Window Frame Is Flush With Center Point Of Rib In Precast Masonry Sill)

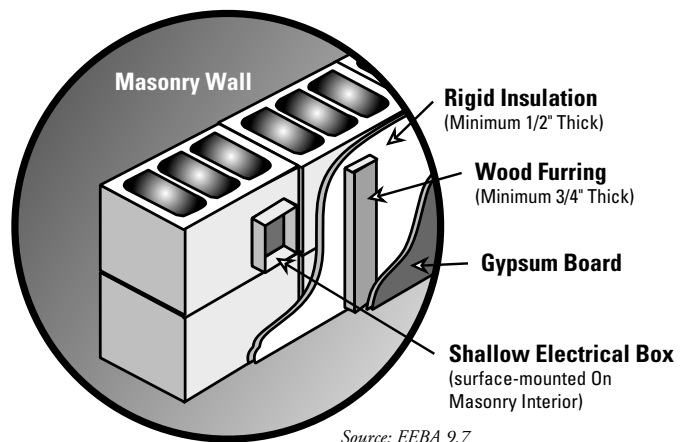
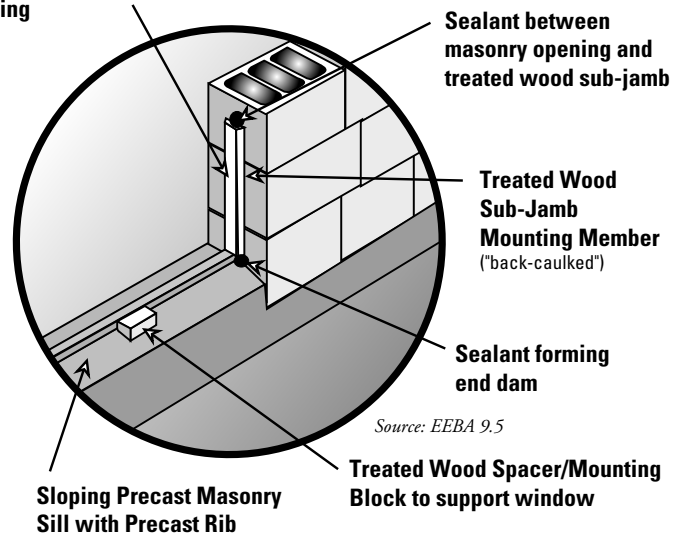

### ELECTRICAL BOX

### Sources & Additional Information

- Lstiburek, J. W. 2000. *Builders Guides*. Minneapolis, MN. Energy and Environmental Building Association. [www.eeba.org](http://www.eeba.org).



# RADIANT BARRIERS

## Building Tips

Radiant Barriers are appropriate for hot climates.

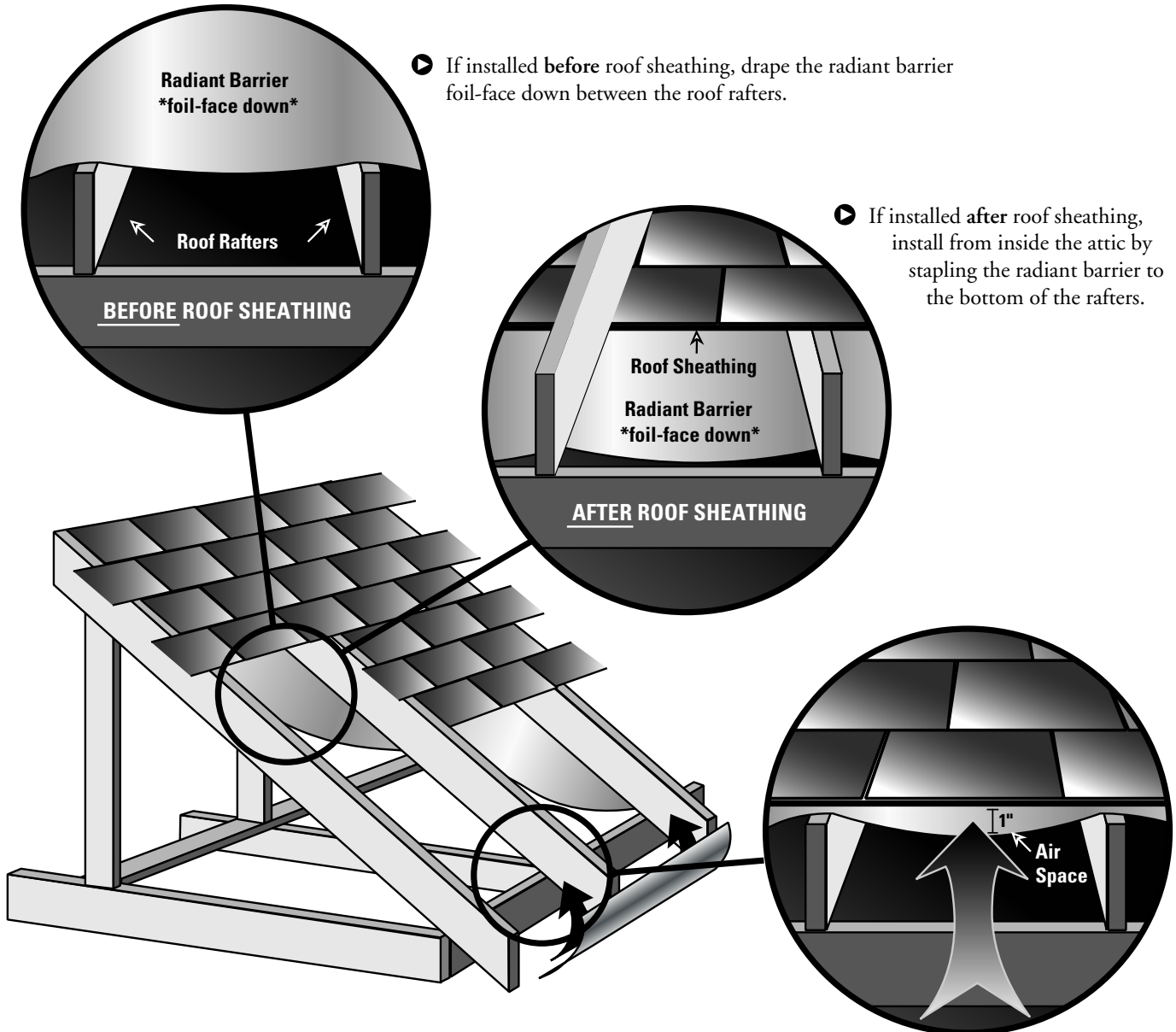

- ▶ If installed **before** roof sheathing, drape the radiant barrier foil-face down between the roof rafters.

- ▶ If installed **after** roof sheathing, install from inside the attic by stapling the radiant barrier to the bottom of the rafters.

- ▶ **NOTE:** Some roof sheathing products have a radiant barrier preinstalled; in this case, ensure the shiny side faces the attic.

- ▶ Allow the material to droop between attachment points to make at least a 1-inch air space between the radiant barrier and the bottom of the roof.

### Sources & Additional Information

- U.S. DOE. *EREC Brief on Radiant Barriers* ([www.eere.energy.gov/consumerinfo/refbriefs/bc7.html](http://www.eere.energy.gov/consumerinfo/refbriefs/bc7.html)).
- Southface Energy Institute. *Fact Sheet #14 Radiant Barriers* ([www.southface.org/home/sfpubs/techshts/14radiantbarriers.pdf](http://www.southface.org/home/sfpubs/techshts/14radiantbarriers.pdf)).
- Southface Energy Institute. *Fact Sheet #25 Ceiling and Attic Insulation and Ventilation* ([www.southface.org/home/sfpubs/techshts/25\\_insulateceilings\\_4pdf.pdf](http://www.southface.org/home/sfpubs/techshts/25_insulateceilings_4pdf.pdf)).



## Building Tips

### AIR HANDLER

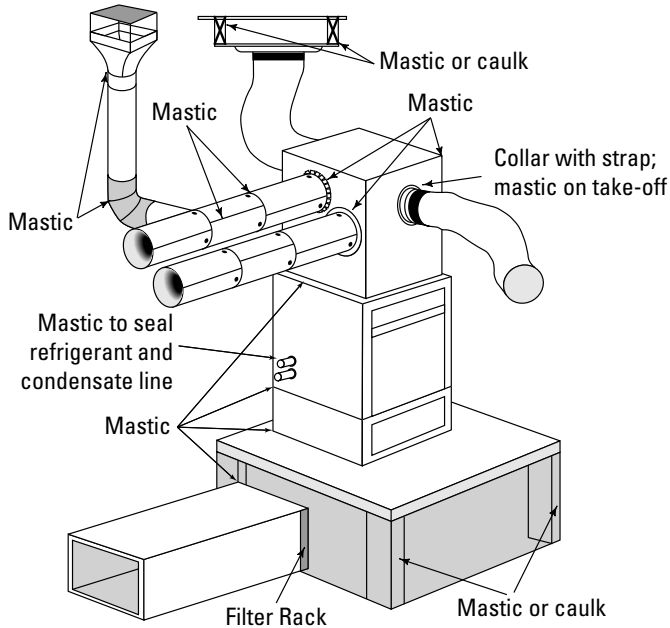

### SUPPLY & RETURN PLENUMS

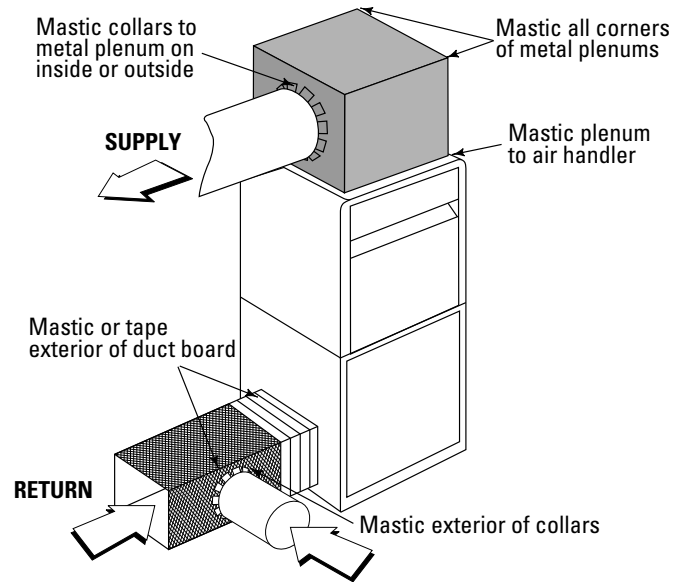

### FLEX DUCT

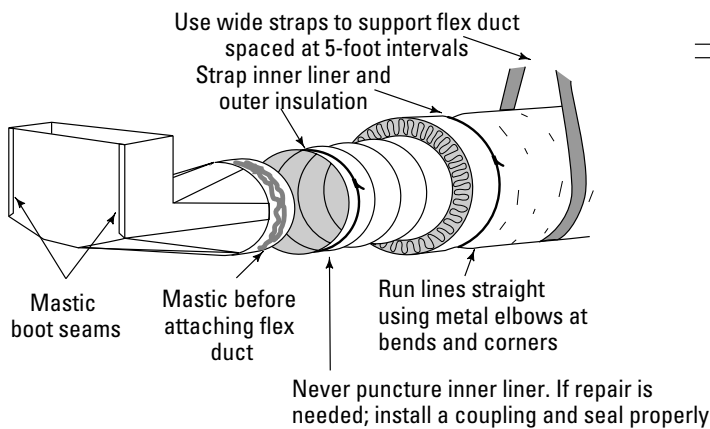

### BOOTS

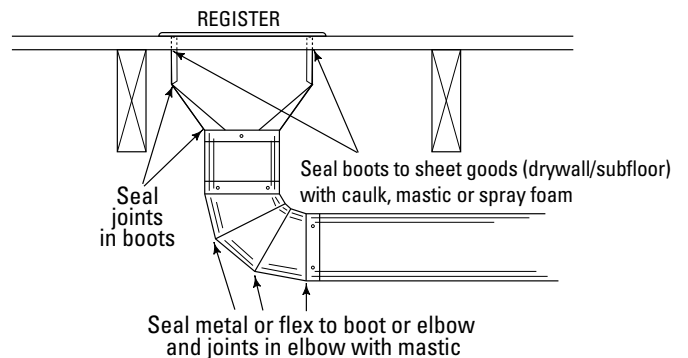

- ▶ Mastic is a gooey adhesive that is applied wet. It fills gaps and dries to a soft solid. Mastics may or may not contain reinforcing fibers, and they may be used with reinforcing mesh tape.

### Sources & Additional Information

- Energy Efficient Building Association *Builder's Guide Hot and Humid Climates*, 2000.
- Southface Energy Institute. *Fact Sheet #2 Ductwork Questions & Answers* ([www.southface.org/home/sfpubs/techshts/2duct\\_q&a.pdf](http://www.southface.org/home/sfpubs/techshts/2duct_q&a.pdf)).
- Southface Energy Institute. *Fact Sheet #18 Energy Checklist* ([www.southface.org/home/sfpubs/techshts/checklist.pdf](http://www.southface.org/home/sfpubs/techshts/checklist.pdf)).
- [www.ibacos.com/ghome/Oct03/bpflexduct.html](http://www.ibacos.com/ghome/Oct03/bpflexduct.html)

\* Diagrams courtesy of Southface Energy Institute *Fact Sheet #2 Ductwork Questions & Answers*.

# FORT LEWIS ARMY BASE

## Washington State

### Energy-Efficient Housing for Our Nation's Military

More than 850 new homes are rising from the misty landscape of the Ft. Lewis Army Base in western Washington State, and all of them are energy efficient, thanks in part to support from the U.S. Department of Energy's Building America program.

High-efficiency 90% AFUE furnaces, high-performance windows, extra attention to caulking and sealing, and ENERGY STAR® appliances and lighting will help the homes achieve energy savings of at least 20% to 30% over the Pacific Northwest's already strong building energy codes, according to Michael Lubliner of the Washington State University Energy Office, part of Building America's Industrialized Housing Partnership.



*Equity Residential and Champion Homes have started construction on 864 energy efficient homes on the (WSU) Ft. Lewis Army Base in Washington State.*

### Military Housing Privatization a Boon to Energy Efficiency

The 864 homes are being built by Equity Residential as part of a 50-year housing privatization contract Equity has entered into with the U.S. Army to assume ownership of all 4,000 existing houses and future homes including the 458 now under construction and another 404 slated for construction starting in 2007. "The Army strongly encourages energy-efficient construction as part of its push for sustainability," said Boyd Lucas, Equity's executive development manager for the project.

"Building America's building science practices help improve our project's energy efficiency, indoor environment, and durability. This is very important to us since we own the houses. Equity will be maintaining and operating these houses in partnership with the U.S. Military over the next 50 years. But we will be paying the utility bills, so energy efficiency is definitely to our benefit;" said Lucas.



*"The military has a tremendous program nationwide to improve sustainability. Energy efficiency is not required but it is always encouraged."*

**Boyd Lucas,**  
Equity Residential, Executive  
Development Manager for the  
Ft. Lewis project

*The Ft. Lewis project is the first military housing project to use modular construction. With modular construction energy efficiency can be implemented cost effectively on a large scale.*

#### INTRODUCTION

*Taking action in your community*



#### HOMEOWNERS

*Shopping for value, comfort, and quality*



#### MANAGERS

*Putting building science to work for your bottom line*



#### MARKETERS

*Energy efficiency delivers the value that customers demand*



#### SITE PLANNERS & DEVELOPERS

*Properly situated houses pay big dividends*



#### DESIGNERS

*Well-crafted designs capture benefits for builders, buyers, and business*



#### SITE SUPERVISORS

*Tools to help with project management*



#### TRADES

*Professional tips for fast and easy installation*

#### CASE STUDIES

*Bringing it all together*



# CASE STUDY: FORT LEWIS ARMY BASE

WSU staff conduct blower door and duct blaster testing on the homes, test insulation density, and verify installation of ENERGY STAR appliances and lighting on site to certify that the homes meet Northwest ENERGY STAR requirements, the energy efficiency level the project chose to meet. WSU also trained the HVAC subcontractor in proper installation, sealing, and testing of the ducts and helped solicit rebates with Puget Sound Energy and locate ENERGY STAR appliance suppliers.

Initial testing and duct leakage estimates by the WSU Energy Office using Energy Gauge software showed that the energy-efficient homes would use 377 therms/year for space heat, compared to similar standard construction homes, which were estimated to use 442 therms/year for space heat. So the improved sealing of ducts could net savings of 65 therms per year. “And in future construction, if the ducts were put in conditioned space, rather than in the crawl space or attic,” said Lubliner, “we estimate savings could approach 100 therms per year.”

WSU Energy is working with the Oregon Department of Energy (ODOE) which provided initial technical assistance to Champion and Equity and assisted with heating system design on the project. ODOE staff also inspect the components of each home at the factory to make sure that all of the energy efficiency specifications are implemented, according to ODOE energy analyst Tom Hewes. WSU and ODOE are working with Champion and Equity to evaluate further energy improvements for future project phases, with US DOE Building America support.

Fort Lewis was one of the first four bases in the country to privatize its housing in response to the Military Housing Privatization Initiative established by Congress in 1996. This is the first military base project for Equity Residential, which is one of the country’s largest real estate investment trusts, with more than 225,000 units nationwide, according to Lucas.



Researchers from Washington State University are evaluating how the bumps and vibrations of highway travel affects the settling of attic insulation installed in the factory.

## THE ENERGY PACKAGE IS:

### Insulation:

- R21 batt insulation in walls
- R33 batt insulation in floors
- R38 loose fill cellulose in ceilings

Windows: double paned low-emissivity, vinyl-framed windows with a U value of 0.35

Doors: metal, foam core with thermal break and U value of 0.2 doors

HVAC: 90% AFUE condensing natural gas furnace located in mechanical room

Ducts: located in attic and crawlspace, insulated to R8

Ducts tested at below target, with total leakage of less than 6% CFM/ft<sup>2</sup> @50 PA (field tests indicate tighter)

Blower door testing: less than 7.0 air changes per hour at 50PA (field tests indicated tighter)

Domestic Hot Water: Powered vent natural gas with an efficiency rating of 0.61

Crawlspace Ventilation: Humidity controlled, fan in vented crawlspace

Whole-house Ventilation: Quiet exhaust fan in central hallway

ENERGY STAR compact fluorescent lamps (CFLs) in 50% of fixtures

ENERGY STAR Dishwasher

## BUILDER PROFILE

### Lewis Communities

#### Where:

Fort Lewis Army Base,  
Washington State  
(south of Seattle, between Olympia  
and Tacoma)

#### Owner:

Fort Lewis Communities LLC

#### Developer:

Equity and Lincoln Properties

#### Modular Builder:

Champion Homes of Oregon

#### Number of Homes:

864

#### Project Start:

January 2005

#### Project Complete:

Spring 2008

#### Home Models:

“The Lincoln”

3 BR, 2-1/2 bath, triplex,  
2 story, 1776 SF/unit,

“The Madison”

4 bedroom, 2-1/2 bath, duplex,  
two story 1016 SF

“The Monroe”

3 bedroom, 2 bath, “adaptable”  
1 story 1635 SF/unit.

“The Roosevelt”

4 bedroom 2 bath “adaptable”  
1 story 1784 SF/unit.

*“For us it’s no more difficult to build energy efficiently than our standard construction process. There was a learning curve, but now it’s just part of our normal production process.”*

**Steve Matus,**

**Champion Silverton’s**

**Quality Control Manager**



# CASE STUDY: FORT LEWIS ARMY BASE

## Energy-Efficient Modular Construction a First for Base Housing

Fort Lewis is probably not the first base to invest in energy-efficient housing under the Defense Department's recent push toward sustainability. But the project is the first to use ENERGY STAR modular construction for energy efficient housing, according to Lucas. House components are being built by Champion Homes at their Silverton, Oregon plant.

Lucas said Equity chose modular construction for several reasons. With so many units going up at one time, wall and roof components can be put together in the factory with significant economies of scale, the preassembled components make for faster set up time on site, and assembling components inside the factory helps them stay drier for less likelihood of damage and mold in Washington State's moist marine climate.

Modular construction was also a first for Champion's Silverton plant, although other Champion plants do a considerable amount of modular construction. The Silverton plant builds primarily manufactured homes and according to Steve Matus, Champion Silverton's quality control manager, Champion has been offering energy-efficient manufactured homes for several years. "For us it's no more difficult to build energy efficiently than our standard construction process. There was a learning curve, but now it's just part of our normal production process."

"There is no question energy-efficient construction is catching on. Maybe 5 or 6 years ago it made up 1% to 2% of our total sales, now its one-fourth to one-third of sales, and some months it's up to half," said Matus.



*Modules are numbered for placement. Housewrap and window flashing has been carefully applied at the factory to exterior walls. Housewrap flaps are provided for overlap with surrounding modules. The housewrap is overlapped shingle-style to create a drainage plain beneath exterior cladding. The foundation wall for the crawlspace can be seen at the base of the walls.*

## The Bottom Line

Equity's Lucas said the whole experience of building energy-efficient homes has been a positive one. "We are always looking to make a better product, in terms of energy efficiency, architecture, design, and cost or value engineering. We know this was the right move for us on this project."

*"There are 4000 units on post, we own them, we pay the utility bill. So energy efficiency is to our benefit."*

**Boyd Lucas,**  
Equity Residential, Executive  
Development Manager for the  
Ft. Lewis project

*"There is no question energy-efficient construction is catching on. Maybe 5 or 6 years ago it made up 1% to 2% of our total sales, now its one-fourth to one-third of sales, and some months it's up to half."*

**Steve Matus,**  
Champion Silverton's  
Quality Control Manager

# SUMMERHILL HOMES

## San Francisco Bay Area

### Every Home an Energy-Efficient Home

SummerHill Homes, based in California's San Francisco Bay area, doesn't offer energy efficiency as an upgrade option, it's a standard feature of every home they build. "We just think it's the right thing to do," said Santos Alvarez, SummerHill's vice president of operations.

According to Alvarez, SummerHill builds about 250 homes per year and the homes typically exceed California's energy code by 18% to 22%. "Our goal is 20%" said Alvarez. They achieve that savings through better insulation, a higher efficiency furnace, an engineered duct system, and more attention to details like caulking and sealing.



Alvarez also attributes the savings to training and on-site inspections. Building America team leader ConSol is one of the inspectors SummerHill works with, using ConSol's ComfortWise version of ENERGY STAR®. "Their field inspectors are sometimes on our job every day. Teaching, training, keeping us up to date—these are some of the things they do for us. They provide formal classroom training and on the job training, including classes for assistants and supervisors, to make sure we are meeting requirements and installing things correctly. They'll also do walk-throughs with our supervisors at the site, pointing out what needs to be paid attention to," said Alvarez.

SummerHill moved to a consistent policy of energy-efficient construction shortly after Alvarez joined the company four and a half years ago. Alvarez had known about ConSol from previous jobs. "Every where I've worked I've pursued energy efficiency," said Alvarez.

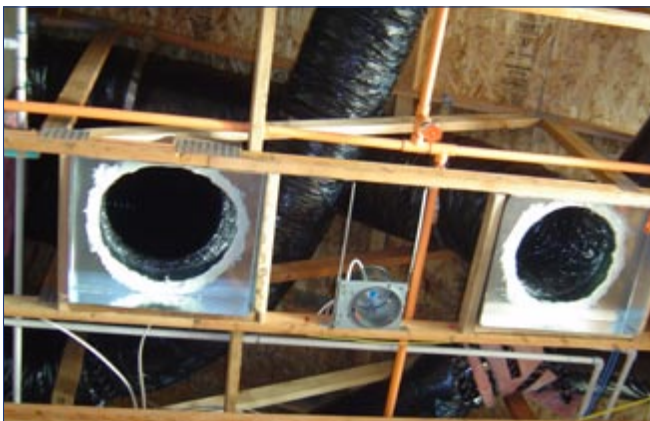

Careful duct sealing with mastic helps improve comfort and energy efficiency at low cost.

### INTRODUCTION

*Taking action in your community*



#### HOMEOWNERS

*Shopping for value, comfort, and quality*



#### MANAGERS

*Putting building science to work for your bottom line*



#### MARKETERS

*Energy efficiency delivers the value that customers demand*



#### SITE PLANNERS & DEVELOPERS

*Properly situated houses pay big dividends*



#### DESIGNERS

*Well-crafted designs capture benefits for builders, buyers, and business*



#### SITE SUPERVISORS

*Tools to help with project management*



#### TRADES

*Professional tips for fast and easy installation*

### CASE STUDIES

*Bringing it all together*



# CASE STUDY: SUMMERHILL HOMES

The policy seems to be a winner for the company as well as the environment. “The sales associates love it,” said Alvarez “they look forward to talking to home buyers about it.”

Alvarez also noted that callbacks have gone down since they started building to ComfortWise standards. “I would attribute this to the additional third-party inspections and training,” said Alvarez.



*Installing window and roof flashing is critical for long-term durability and must happen at the correct stages of construction.*



*Housewrap provides a drainage plain behind stucco and other finishes.*

## Key Features:

Field certification with two inspections of each model and each floor plan per release using diagnostics: blower door test, duct blaster test, air flow measurements at each register, insulation density measurements; visual inspection that specified components are installed correctly.

Caulking and sealing of all joints and penetrations

Engineered HVAC system and duct layout

Sealed ducts with duct blaster testing

Correct sizing of air conditioning equipment

Dual-paned vinyl windows with Low-E glass for improved energy savings

All exterior doors feature full weather stripping

Dual-zone high-efficiency forced air gas furnace with electronic ignition and energy efficient electronic set-back thermostat

Energy saving 100-gallon gas water heater with recirculation pump to all fixtures

## BUILDER PROFILE

**SummerHill Homes,**  
a division of **Marcus  
& Millichap**

### Where:

San Francisco Bay Area,  
California

### Founded:

1976

### Employees:

120

### Development:

Villa Savona Homes in  
Fremont, California

### Number of Homes:

26

### Square Footage:

3,545 - 3,889 sq. ft.

3 - 5 bedrooms

3.5 - 4.5 baths

### Price Range:

from the mid \$1,500,000's



*High efficiency windows improve comfort and help protect furnishings from solar radiation. This National Fenestration Rating Council label shows a U-factor of 0.35 and solar heat gain coefficient of 0.31. The window also qualifies as an ENERGY STAR product.*

# CASE STUDY: SUMMERHILL HOMES

## Innovations

SummerHill has gone beyond the ENERGY STAR standards to incorporate green building practices in their homes as well. Alvarez said this started about two years ago with their Sycamore Heights development located in Alameda County. They implemented several green building features including using recycled materials, protecting native soil, minimizing disruption of existing plants and trees, recycling at the construction site, using formaldehyde-free insulation, and installing gas water heaters with a recirculation pump to all fixtures. Several of these features were required by Alameda County as part of the county's Green Building Guidelines. Sycamore Heights achieved the county's Gold Level Status for green construction. Now SummerHill incorporates these features in all of its new construction.

"When we looked at what was required to achieve Gold Level Status, 90% of it we were already doing," said Alvarez.

SummerHill's efforts have been recognized by the building community. SummerHill developments have received several coveted Best In American Living Awards from the National Association of Home Builders, and SummerHill was the winner of two Golden Nugget Grand Awards and five Gold Nugget Merit Awards at the 2005 Pacific Coast Builders Conference.

### Don't Duck Duct Details:

ConSol contends that sealing HVAC ducts is a key to improving a home's energy efficiency. ConSol aims for a duct leakage goal of less than 6% leakage. "The biggest source of leakage in duct systems is from not sealing the can that holds the AC duct to the register. The can should be sealed to the drywall with caulk. We estimate that 40% of duct leakage is due to that omission alone," said Doug Dryer, ConSol's national marketing director. To ensure that ducts are tight, ConSol performs field inspections and diagnostics including duct blaster tests and measurements of air flow at each register in the home. ConSol's mechanical engineers design the HVAC system for each floor plan to determine the correct size for the heating and air conditioning equipment and to optimize the duct layout. "The ideal is a perfectly balanced house, pressure wise, with a correctly sized HVAC system and adequate air flow into each room," said Dryer.



## Green Features

In addition to energy efficiency, SummerHill Homes's Sycamore Heights development meets the requirements of Alameda County's Green Building Program. These include:

### Materials & Products

- 15% fly ash in concrete
- Engineered lumber for floors, structural beams and headers
- Wood I-joists for floors and ceilings
- OSB for subfloors and sheathing
- Finger-jointed trim
- Non-chromium/arsenic treated wood
- Fiber-cement exterior siding (James Hardie Hardiplank and Hardishingle)
- Durable concrete roof tiles (Monier Lifetile)

### Other Green Features

- 75% recycling of construction waste
- Reused form boards
- Built-in recycling center
- Stormwater management and soil protection during construction
- High-efficiency irrigation system and resource-efficient landscapes
- Range hoods vented to outside
- Low-VOC\* interior paint (\*volatile organic compounds)

## **ConSol's ComfortWise ENERGY STAR promotes Building America's Common Sense Building Science Principles**

ConSol is the team lead for the Building Industry Research Alliance, one of Building America's research consortia. ConSol's ComfortWise ENERGY STAR program is based on the common sense building science principles that Building America has developed and promotes. By following this whole house systems approach, builders can build high-quality durable homes that use at least 30% less energy for space heating and cooling than homes built to meet the National Model Energy Code or 15% savings over homes built to the California Energy Code. ConSol provides builders with an HVAC layout and design as well as full energy code and lender documentation. ConSol specifies spectrally selective low-emissivity windows and tight ducts and provides on-site third-party inspections and diagnostic testing including duct blaster, blower door, insulation density, air flow, and other measurements. ConSol also provides marketing support and materials, sales staff and contractor training, and information on energy-efficient mortgages to help builders implement energy efficiency practices and use them to expand markets and increase profitability.

### **The Bottom Line**

According to Alvarez: "Cost is not a big issue. It's not hard and it's not expensive. It's just a little more work. It takes a little more attention. And you've got to allow the time for testing and inspection."

# APPENDIX I

## Homebuyer's Checklist

Below is a more detailed list of building features for those who really want to investigate their house. To really see how some of these measures are installed, visit houses that are under construction.

MEASURE	Building America Recommendations	Builder #1	Builder #2	Builder #3
<b>HEATING AND COOLING EQUIPMENT</b>				
ENERGY STAR qualified air conditioning of <b>SEER* 13 or greater (SEER 14 starting Jan 2006)</b>	Yes			
ENERGY STAR qualified heat pump	Yes			
ENERGY STAR qualified boiler	Yes			
ENERGY STAR qualified furnace of <b>AFUE* 90</b>	Yes			
ENERGY STAR qualified programmable thermostat	Yes			
Ductwork sealed with mastic (no duct tape)	Yes			
<b>5% or less</b> duct leakage found with pressure test	Yes			
Duct Insulation: <b>R-4</b> in conditioned space, <b>R-8</b> in attic, <b>R-6</b> in crawlspace	Yes			
House plans show duct layouts	Yes			
Ducts located in conditioned space as much as possible	Yes			
Ducts sized according to industry standards in <b>Manual D</b>	Yes			
Heating and cooling equipment sized according to industry standards in <b>Manual J</b>	Yes			
House pressure balanced with jump ducts	Yes			
HVAC* equipment and duct work was inspected and tested after installation	Yes			
<b>INSULATION</b> <i>(take a look at a house under construction before sheetrock is installed)</i>				
Insulation installed behind tubs, landings, and other hard to reach places	Yes			
Insulation fills entire cavities – no voids or compressed batts – Attic insulation level without gaps and covers entire attic floor	Yes			
Where fiberglass batt insulation is used it is high-density	Yes			
Rim joists are insulated	Yes			
<b>WINDOWS</b> <i>(take a look at a house under construction before exterior siding is installed)</i>				
ENERGY STAR qualified windows, doors, and skylights	Yes			
Windows flashed to help repel water	Yes			
Windows rated to 0.35 U-factor and SHGC	Yes			

# APPENDIX I: HOMEBUYER'S CHECKLIST

<b>MOISTURE MANAGEMENT</b> <i>(take a look at a house under construction before exterior siding is installed)</i>				
Ground slopes away from house	Yes			
Housewrap or building paper covers exterior sheathing in wood framed houses	Yes			
Roof flashing in valleys, where walls and roofs intersect, and at other places where water may enter the house – the more complex the roof, the more flashing you should see	Yes			
Overhangs for shade and to direct water away from walls	Yes			
<b>AIR BARRIERS</b>				
All penetrations through exterior walls sealed	Yes			
Careful sealing of sheetrock or exterior sheathing	Yes			
Canned lights rated as airtight and for insulated ceiling (ICAT)	Yes			
Electrical boxes on exterior walls caulked or gasketed	Yes			
Holes into attic sealed	Yes			
Attic hatch weather-stripped and insulated	Yes			
Air leakage determined with house depressurization test	Yes			
Wall-roof intersection carefully sealed to avoid ice dams	Yes			
Draft stops installed behind tubs, showers, stairs, and fireplaces	Yes			
<b>FOUNDATION MEASURES</b>				
Radon control measures installed	Yes			
4 to 6 inch gravel base under slab and basement floors	Yes			
Polyethylene (plastic) vapor barrier between gravel and slab	Yes			
Conditioned crawlspace	Yes			
Exterior wall insulation	Yes			
<b>PLUMBING</b>				
No pipes in exterior walls	Yes			
Pipe insulation	Yes			
<b>YOUR FEATURES FOR COMPARISON</b>				

\*SEER: Seasonal Energy Efficiency Ratio

\*AFUE: Annual Fuel Utilization Efficiency

\*HVAC: heating, ventilation, and air conditioning

If you want to know more about any of these or other house features review the other chapters of the *Best Practices* guide. Other chapters are designed to help site planners, designers, site supervisors, and crafts people design and build efficient, comfortable, and durable homes.

## *Energy & Housing Glossary*

### **Accreditation**

The process of certifying a Home Energy Rating System (HERS) as being compliant with the national industry standard operating procedures for Home Energy Rating System.

### **AFUE Annual Fuel Utilization Efficiency (AFUE)**

Measures the amount of fuel converted to space heat in proportion to the amount of fuel entering the furnace. This is commonly expressed as a percentage. A furnace with an AFUE of 90 could be said to be 90% efficient. AFUE includes any input energy required by the pilot light but does not include any electrical energy for fans or pumps.

### **Air Flow Retarder**

Sealants used to keep outside air and inside air out of the building envelope. Four common approaches to retarding air flow include careful sealing using the following building components: drywall and framing, plastic sheets (should not to be used in hot and humid climates) between drywall and framing, exterior sheathing, and building paper. Air flow retarders define the pressure boundary in a house that separates indoor and outdoor air.

### **Building Envelope**

The outer shell, or the elements of a building, such as walls, floors, and ceilings, that enclose conditioned space. See also *Pressure Boundary* and *Thermal Boundary*.

### **Btu (British Thermal Unit)**

A standard unit for measuring energy. One Btu is the amount of energy required to raise the temperature of one pound of water by one degree Fahrenheit from 59 to 60. An Inches-Pounds unit.

### **CABO (Council of American Building Officials)**

A national organization of building code officials and interested parties, which, through a national consensus process, developed, adopted and promulgated the national Model Energy Code (MEC). CABO has recently become CABO International and has taken on the administrative responsibility for the development of a uniform international building code through an International Code Council (ICC).

### **Capacity**

The rate at which a piece of equipment works. Cooling capacity is the amount of heat a cooling system can remove from the air. For air conditioners total capacity is the sum of latent capacity, the ability to remove moisture from the air, and the sensible capacity, the ability to reduce dry-bulb temperature. Heating system capacity indicates how much heat a system can provide. Heating and cooling capacities are rated in Btu per hour.

### **Chase**

An enclosure designed to hold ducts, plumbing, electric, telephone, cable, or other linear components. A chase designed for ducts should be in conditioned space and include air flow retarders and thermal barriers between it and unconditioned spaces such as attics.

### **Closed Combustion**

See *Sealed Combustion*, *Direct Vent*, and *Power Vent*.

### **Construction Documents**

The drawings (plans) and written specifications that describe construction requirements for a building.



## APPENDIX II: ENERGY & HOUSING GLOSSARY

### Cooling Degree-Day

A cooling degree-day is a measure of how hot a location is over a period of time relative to a base temperature, most commonly specified as 65 degrees Fahrenheit. The measure is computed for each day by subtracting the base temperature (65 degrees) from the average of the day's high and low temperatures, with negative values set equal to zero. Each day's cooling degree-days are summed to create a cooling degree-day measure for a specified reference period. Cooling degree-days are used in energy analysis as an indicator of air-conditioning energy requirements or use.

### COP (Coefficient of Performance)

A measure of efficiency typically applied to heat pumps. The COP for heat pumps is the ratio, at a given point in time, of net heat output to total energy input expressed in consistent units and under designated conditions. Heat pumps result in a COP greater than 1 because the system delivers or removes more heat energy than it consumes. Other specific definitions of COP exist for refrigeration equipment. See HSPF for a description of a unit for seasonal efficiency.

### Debt-to-Income Ratio

The ratio, expressed as a percentage, which results when a borrower's total monthly payment obligations on long-term debt are divided by their gross monthly income. This is one of two ratios (housing expense-to-income ratio being the other) used by the mortgage industry to determine if a prospective borrower qualifies (meets the underwriting guidelines) for a specific home mortgage. Fannie Mae, Freddie Mac and FHA underwriting guidelines set an upper limit of 36% on this value for conventional loans but increase ("stretch") the ratio by 2% for qualifying energy efficient houses.

### Direct Vent

A sealed ventilation system for combustion appliances that draws combustion air from outside the structure and vents combustion exhaust outside the structure. These systems may be combined with power vent exhausts. See *Power Vent and Sealed Combustion*.

### Dry-Bulb Temperature

The temperature of air indicated on an ordinary thermometer, it does not account for the affects of humidity.

### ECM (Energy Conservation Measure)

An individual building component or product that directly impacts energy use in a building.

### EEM (Energy Efficient Mortgage)

Specifically, a home mortgage for which the borrower's qualifying debt-to-income and housing expense-to-income ratios have been increased ("stretched") by 2% because the home meets or exceeds CABO's 1992 version of the Model Energy Code (MEC). This so-called "stretch" mortgage is nationally underwritten by Fannie Mae, Freddie Mac and the Federal Housing Administration (FHA). This term is often used generically to refer to any home mortgage for which the underwriting guidelines have been relaxed specifically for energy efficiency features, or for which any form of financing incentive is given for energy efficiency.

### EER (Energy Efficiency Ratio)

A measurement of the instantaneous energy efficiency of cooling equipment, normally used only for electric air conditioning. EER is the ratio of net cooling capacity in Btu per hour to the total rate of electric input in watts, under designated conditions. The resulting EER value has units of Btu per watt-hour.

### EF (Energy Factor)

A standardized measurement of the annual energy efficiency of water heating systems. It is the annual hot water energy delivered to a standard hot water load divided by the total annual purchased hot water energy input in consistent units. The resultant EF value is a percentage. EF is determined by a standardized U.S. Department of Energy (DOE) procedure.

### Energy (use)

The quantity of onsite electricity, gas or other fuel required by the building equipment to satisfy the building heating, cooling, hot water, or other loads or any other service requirements (lighting, refrigeration, cooking, etc.)

### Energy Audit

A site inventory and descriptive record of features impacting the energy use in a building. This includes, but is not limited to: all building component descriptions (locations, areas, orientations, construction attributes and energy transfer characteristics); all energy using equipment and appliance descriptions (use, make, model, capacity, efficiency and fuel type) and all energy features.

## APPENDIX II: ENERGY & HOUSING GLOSSARY

### **ENERGY STAR® Home**

A home, certified by the U.S. Environmental Protection Agency (EPA), that is at least 30% more energy efficient than the minimum national standard for home energy efficiency as specified by the 1992 MEC, or as defined for specific states or regions. ENERGY STAR is a registered trademark of the EPA.

### **Envelope**

*See Building Envelope*

### **Fannie Mae**

#### **(FNMA - Federal National Mortgage Association)**

A private, tax-paying corporation chartered by the U.S. Congress to provide financial products and services that increase the availability of housing for low-, moderate-, and middle-income Americans.

### **FHA (Federal Housing Administration)**

A division of the U.S. Department of Housing and Urban Development (HUD). FHA's main activity is the insurance of residential mortgage loans made by private lenders.

### **Freddie Mac**

#### **(FHLMC - Federal Home Loan Mortgage Corporation)**

A stockholder-owned organization, chartered by the U.S. Congress to increase the supply of mortgage funds. Freddie Mac purchases conventional mortgages from insured depository institutions and HUD-approved mortgage bankers.

### **Grade Beam**

A foundation wall that is poured at or just below the grade of the earth, most often associated with the deepened perimeter concrete section in slab-on-grade foundations.

### **Heating Degree-Day**

A heating degree-day is a unit of measure of how cold a location is over a period of time relative to a base temperature, most commonly specified as 65 degrees Fahrenheit. The measure is computed for each day by subtracting the average of the day's high and low temperatures from the base temperature (65 degrees), with negative values set equal to zero. Each day's heating degree-days are summed to create a heating degree-day measure for a specified reference period.

### **HERS (Home Energy Rating System)**

A standardized system for rating the energy-efficiency of residential buildings.

### **HERS Energy-Efficient Reference Home (EERH)**

The EERH is a geometric "twin" to a home being evaluated for a HERS rating and according to a newly-revised system, is configured to be minimally compliant with the 2004 International Energy Conservation Code.

### **HERS Provider**

An individual or organization responsible for the operation and management of a Home Energy Rating System (HERS).

### **HERS Rater**

An individual certified to perform residential building energy efficiency ratings in the class for which the rater is certified.

### **HERS Index**

A value between 0 and 100 indicating the relative energy efficiency of a given home as compared with the HERS Energy-Efficient Reference Home as specified by the HERS Council Guidelines. The greater the score, the more efficient the home. A home with zero energy use for the rated energy uses (heating, cooling and hot water only) scores 100 and the HERS Reference Home scores 80. Every one point increase in the HERS score amounts to a 5% increase in energy efficiency.

### **Housing Expense-to-Income Ratio**

The ratio, expressed as a percentage, which results when a borrower's total monthly housing expenses (P.I.T.I.) are divided by their gross monthly income. This is one of two ratios (debt-to-income ratio being the other) used by the mortgage industry to determine if a prospective borrower qualifies (meets the underwriting guidelines) for a specific home mortgage. Fannie Mae, Freddie Mac and FHA underwriting guidelines set an upper limit of 28% on this value for conventional loans but increase ("stretch") the ratio by 2% for qualifying Energy Efficient Mortgages (EEM).

### **Housewrap**

Any of several spun-fiber polyolefin rolled sheet goods for wrapping the exterior of the building envelope.

## APPENDIX II: ENERGY & HOUSING GLOSSARY

### **HSPF (Heating Season Performance Factor)**

A measurement of the seasonal efficiency of an electric heat pump using a standard heating load and outdoor climate profile over a standard heating season. It represents the total seasonal heating output in Btu divided by the total seasonal electric power input in watt-hours (Wh). Thus, the resultant value for HSPF has units of Btu/Wh.

### **Jump Duct**

A flexible, short, U-shaped duct (typically 10-inch diameter) that connects a room to a common space as a pressure balancing mechanism. Jump ducts serve the same function as transfer grilles.

### **Load**

The quantity of heat that must be added to or removed from the building (or the hot water tank) to satisfy specific levels of service, such as maintaining space temperature or hot water temperature at a specified thermostat setting (see also the definitions of energy and thermostat).

### **Low-E**

Refers to a coating for high-performance windows, the “E” stands for emissivity or re-radiated heat flow. The thin metallic oxide coating increases the U-value of the window by reducing heat flow from a warm(er) air space to a cold(er) glazing surface. Low-E coatings allow short-wavelength solar radiation through windows, but reflect back longer wavelengths of heat.

### **MEC (Model Energy Code)**

A “model” national standard for residential energy efficiency. The MEC was developed through a national consensus process by the Council of American Building Officials (CABO) and is the accepted national minimum efficiency standard for residential construction. Since MEC is a model code, it does not have the “force of law” until it is adopted by a local code authority. The MEC is used as the national standard for determining Energy Efficient Mortgage (EEM) qualification, and it serves as the national “reference point” used by Home Energy Rating Systems (HERS) in the determination of energy ratings for homes.

### **Mechanical Ventilation**

The active process of supplying or removing air to or from an indoor space by powered equipment such as motor-driven fans and blowers, but not by devices such as wind-driven turbine ventilators and mechanically operated windows.

### **Performance Test**

An on-site measurement of the energy performance of a building energy feature or an energy using device conducted in accordance with pre-defined testing and measurement protocols and analysis and computation methods. Such protocols and methods may be defined by national consensus standards like those of the American Society of Heating, Refrigerating and Air Conditioning Engineers (ASHRAE) and the American Society for Test and Measurement (ASTM).

### **Perm**

A unit of measure of water vapor permeance. One perm equals one grain of water vapor per hour flowing through one square foot of material at a differential vapor pressure equal to one inch of mercury. The greater the number, the more water vapor that will pass through a given material.

### **P.I.T.I.**

An abbreviation which stands for principal, interest, taxes, and insurance. These generally represent a borrower’s total monthly payment obligations on a home loan. The taxes and insurance portion are often paid monthly to an impound or escrow account and may be adjusted annually to reflect changes in the cost of each.

### **Power Vent**

A sealed exhaust ventilation system for combustion appliances that uses a fan to move combustion exhaust out of the structure. See *Direct Vent and Sealed Combustion*.

### **Pressure Boundary**

The point in a building at which inside air and outside air are separated. If a building were a balloon, the rubber skin would form the pressure boundary. Where inside and outside air freely mingle there is no pressure boundary.

## APPENDIX II: ENERGY & HOUSING GLOSSARY

### **Pressurization Test**

A procedure in which a fan is used to place a house, duct system, or other container, under positive or negative air pressure in order to calculate air leakage.

### **RESNET (Residential Energy Services Network)**

The national association of energy rating providers.

### **Rated Home**

A specific residence that is evaluated by an energy rating.

### **R-Value**

Measures a material's ability to slow down or resist the transfer of heat energy, also called thermal resistance. The greater the R-value, the better the resistance, the better the insulation. R-values are the reciprocal of U-values. See U-values for more information.

### **Sealed Combustion**

Sealed combustion means that a combustion appliance, such as a furnace, water heater, or fireplace, acquires all air for combustion through a dedicated sealed passage from the outside; combustion occurs in a sealed combustion chamber, and all combustion products are vented to the outside through a separate dedicated sealed vent. See *Direct Vent and Sealed Combustion*.

### **SEER (Seasonal Energy Efficiency Ratio)**

A measurement similar to HSPF except that it measures the seasonal cooling efficiency of an electric air conditioner or heat pump using a standard cooling load and outdoor climate profile over a standard cooling season. It represents the total seasonal cooling output in Btu divided by the total seasonal electric input in watt-hours (Wh). The SEER value are units of Btu/Wh.

### **Semi-Permeable**

The term vapor semi-permeable describes a material with a water vapor permeance between 1 and 10 perms. Water vapor can pass through a semi-permeable material but at a slow rate.

### **Shading Coefficient (SC)**

The ratio of the total solar heat admittance through a given glazing product relative to the solar heat admittance of double-strength, clear glass at normal solar incidence (i.e., perpendicular to the glazing surface).

### **Solar Heat Gain Coefficient (SHGC)**

SHGC measures how well a window blocks heat caused by sunlight. The lower the SHGC rating the less solar heat the window transmits. This rating is expressed as a fraction between 0 and 1. The number is the ratio of a window's solar heat admittance compared to the total solar heat available on the exterior window surface at normal solar incidence (i.e., perpendicular to the glazing surface).

### **Sone**

A sound rating. Fans rated 1.5 sones and below are considered very quiet.

### **Supply ducts**

The ducts in a forced air heating or cooling system that supply heated or cooled air from the air conditioner to conditioned spaces.

### **Thermal Boundary**

The border between conditioned and unconditioned space where insulation should be placed.

### **Thermostat**

A control device that measures the temperature of the air in a home or the water in a hot water tank and activates heating or cooling equipment to cause the air or water temperature to remain at a pre-specified value, normally called the set point temperature.

### **Ton(s) of Refrigeration**

Units used to characterize the cooling capacity of air conditioning equipment. One ton equals 12,000 Btu/h.

### **U-Value**

Measures the rate at which heat flows or conducts through a building assembly (wall, floor, ceiling, etc.). The smaller the u-value the more energy efficient an assembly and the slower the heat transfer. Window performance labels include U-values (calling them U-factors) to help in comparing across window products.

### **Vapor Diffusion**

Vapor diffusion describes the molecular process in which vapor moves moisture from areas of higher vapor pressure to areas of lower vapor pressure, and from areas of greater temperature to areas of lesser temperature.

# APPENDIX II: ENERGY & HOUSING GLOSSARY

## Sources & Additional Information

- American Society of Heating, Refrigeration and Air Conditioning Engineers (ASHRAE). 1991. *Terminology of Heating Ventilation Air Conditioning and Refrigeration*. Atlanta, GA.
- Building News. 2001. *Construction Dictionary*. BNi Publications, Los Angeles, CA.
- Florida Solar Energy Center (FSEC). *Energy-Efficiency Economics Terms and Definitions* available on the Web at [www.fsec.ucf.edu/bldg/fyh/ratings/e\\_terms.htm](http://www.fsec.ucf.edu/bldg/fyh/ratings/e_terms.htm)
- Lstiburek, Joseph. 2002. *Builder's Guide Hot and Humid Climates*. Energy & Environmental Building Association. Minneapolis, MN [www.eeba.org](http://www.eeba.org)
- *Home Energy Magazine*. 1997. "No-Regrets Remodeling: Creating a Comfortable, Healthy Home That Saves Energy." Energy Auditor & Retrofitter, Inc. Berkeley, CA.

## *Code Notes*

A meeting with the building department before construction is well-advised. Should your code official need information in support of the new techniques you may use in an energy-efficient home, this appendix contains Web sites and a sample document that may be helpful. A set of draft code notes are available on DOE's Building Energy Codes Resource Center. These draft documents are written for codes officials, and provide a description of energy efficiency techniques, citations to relevant codes, and guidance for plan reviews and field inspections. The sample is the last one on the list below and is entitled *Rigid Board Insulation Installed as Draft Stop in Attic Kneewall – Code Notes (Draft)*. Here is a list of available code notes that should help assure your local code official that the proposed techniques are both safe and in compliance with the model codes. The code notes are available at [www.energycodes.gov/support/code\\_notes.stm](http://www.energycodes.gov/support/code_notes.stm).

- Single Top Plate
- No Headers in Nonbearing Walls
- Header Hangers in Bearing Walls
- Framing Floor Joists Spaced at 24 inches on Center
- Framing Studs Spaced at 24 inches on Center
- Open Spaces as Return-Air Options
- Details for Mechanically Vented Crawl Spaces
- Ventilation Requirements for Condensing Clothes Dryers
- Drywall Clips
- Rigid Board Insulation Installed as Draft Stop in Attic Kneewall



## Rigid Board Insulation Installed as Draft Stop in Attic Kneewall - Code Notes (DRAFT)



Framing kneewall

Rigid board insulation (foam plastic) is an effective draft stop and also increases the R-value of the attic kneewall if installed on the attic side of the kneewall, replacing the need for separate draft stop and insulation products. The IRC requires foam plastic insulation to be protected against ignition by using fiberglass batt insulation, gypsum board or other products that meet the flame and smoke density requirements. Foam plastic products rated for flame and smoke density can be installed without such a protective covering.

Insulating attic kneewalls between a conditioned space with vaulted ceilings and the attic is important to reduce energy loss through the wall, especially in the summer months. To be effective, the insulation installed in the kneewalls must be supported so that it stays in contact with the gypsum board, and protected against air moving through the insulation.



photo by Britt-Makela Group

Kneewall sheathing insulation to increase R-value to equal the outside wall.

Foam plastic insulation can be installed on the attic side of the attic kneewall (see Figure) to both act as a draft stop between the conditioned house and the unconditioned attic and to increase the insulation R-value of the attic kneewall. Installing such an insulating backing in the kneewall supports the fiberglass batt insulation between framing members, replaces an air barrier, and adds insulating value to the attic kneewall.

## Plan Review

1. Verify that plastic insulation called out on the construction detail meets the ASTM E 84 requirements for flame spread and smoke development. Require manufacturer literature or an ICC Evaluation Service report.
2. Verify that the insulation R-value of the foam plastic insulation called out on the building plans meets or exceeds the R-value requirements called for on the energy code compliance documentation (only if credit has been taken for the foam plastic insulation).

## Field Inspection

1. Verify that the foam plastic insulation installed in the field is consistent with that called out on the building plans.
2. Verify that the insulation R-value specified on the insulation meets or exceeds the R value called out on the plans or documentation.
3. Verify that that sealant has been installed around the edges of the insulation and that any holes or penetrations in the foam plastic insulation are sealed.

## Code Citations



**IRC 2000, Section R318.2.3 and IRC 2003, Section R314.2.3**

Within attics and crawlspaces, where entry is made only for service of utilities, foam plastics shall be protected against ignition by 1 1/2-inch-thick (38 mm) mineral fiber insulation, 1/4-inch-thick (6.4 mm) wood structural panels, 3/8-inch (9.5 mm) particleboard, 1/4-inch (6.4 mm) hardboard, 3/8-inch (9.5 mm) gypsum board, or corrosion resistant steel having a base metal thickness of 0.016 inch (0.406 mm).

**IRC 2000, Section R318.3**

Plastic foam not meeting the requirements of Section R318.1 and R318.2 may be specifically approved on the basis of one of the following approved tests: ASTM E 84, FM 4880, UL 1040, ASTM E152, or UL 1715, or fire tests related to actual end-use configurations. The specific approval may be based on the end use, quantity, location and similar considerations where such tests would not be applicable or practical.

**IRC 2003, Section R314.3**

Plastic foam not meeting the requirements of Section R318.1 and R318.2 may be specifically approved on the basis of one of the following approved tests: ASTM E 84, FM 4880, UL 1040, NFPA 286, ASTM E152, or UL 1715, or fire tests related to actual end-use configurations. The specific approval may be based on the end use, quantity, location and similar considerations where such tests would not be applicable or practical.

## Counties in the Marine Climate

This section contains a list of all the counties, broken out by state, that are inside the marine climate. You can find a master list for the entire country at [www.eere.energy.gov/buildings/building\\_america/pdfs/climate\\_regions\\_us\\_county\\_rev02.pdf](http://www.eere.energy.gov/buildings/building_america/pdfs/climate_regions_us_county_rev02.pdf)

MARINE CLIMATE

CALIFORNIA	OREGON	WASHINGTON
Alameda	Benton	Clallam
Del Norte	Clackamas	Clark
Humboldt	Clatsop	Cowlitz
Marin	Columbia	Grays Harbor
Mendocino	Coos	Jefferson
Monterey	Curry	King
Napa	Douglas	Kitsap
San Benito	Jackson	Lewis
San Francisco	Josephine	Mason
San Luis Obispo	Lane	Pacific
San Mateo	Lincoln	Pierce
Santa Barbara	Linn	Skagit
Santa Clara	Marion	Snohomish
Santa Cruz	Multnomah	Thurston
Sonoma	Polk	Wahkiakum
Ventura	Tillamook	Whatcom
	Washington	
	Yamhill	

## Web Site References

This section lists all of the Web sites referenced in the Best Practices Series. It is intended to help readers in two ways. First, those interested in finding a reference without going back through the text may do so. Secondly, this list will be included as a live portion of the Building America Web site. The list will be updated periodically to incorporate changes in links. In this way, readers may visit the Building America Web site and click on a current link rather than monitoring and tracking down links on their own. The links are listed by chapter and for the *Designers* and *Trades* chapters, also by secondary headings.

---

### INTRODUCTION

---

#### [www.buildingamerica.gov](http://www.buildingamerica.gov)

Building America is a private/public partnership that develops energy solutions for new and existing homes.

---

### HOMEOWNERS

---

#### [www.ornl.gov/sci/roofs+walls/insulation/ins\\_16.html](http://www.ornl.gov/sci/roofs+walls/insulation/ins_16.html)

Easy to use R-value recommendation form uses input such as house status, fuel type and zip code to form analysis for installation.

#### [www.fanniemae.com](http://www.fanniemae.com)

Known for energy-efficient loans, Fannie Mae is the nation's largest source of funding for mortgages.

#### [www.natresnet.org](http://www.natresnet.org)

The Residential Energy Services Network's (RESNET) mission is to improve the energy efficiency of the nation's housing stock and to qualify more families for home ownership by expanding the national availability of mortgage financing options and home energy ratings.

#### [www.hud.gov/offices/hsg/sfh/eem/energy-r.cfm](http://www.hud.gov/offices/hsg/sfh/eem/energy-r.cfm)

Energy Efficient Mortgages Programs helps to achieve national energy-efficiency goals (and reduce pollution) as well as provide better housing for people who might not otherwise be able to afford it.

#### [www.eflhome.com/index.jsp](http://www.eflhome.com/index.jsp)

The Environments for Living Program's energy use and comfort guarantees promise potential savings, comfort and durability that were never thought possible.

#### [www.us-gf.com/engineered.asp](http://www.us-gf.com/engineered.asp)

An Engineered For Life® home is an energy-efficient home that has been designed, built and tested according to the principles of building science for optimal safety, durability, affordability, and comfort.

#### [www.artistichomessw.com/guarantee.htm](http://www.artistichomessw.com/guarantee.htm)

Artistic Homes clearly marks every new home floor-plan with the annual amount of space heating and cooling energy that is expected to be used. Artistic Homes' guarantee: If your actual space heating and cooling usage is less than guaranteed, you pay less.

#### [www.energystar.gov](http://www.energystar.gov)

ENERGY STAR is a government-backed program helping businesses and individuals protect the environment through superior energy efficiency.

#### [www.buildingamerica.gov](http://www.buildingamerica.gov)

Building America is a private/public partnership that develops energy solutions for new and existing homes.

#### [www.housingzone.com](http://www.housingzone.com)

Housingzone.com contains content for builders, remodelers, architects, suppliers, consumers, and manufacturers. The Web site includes material from *Professional Builder*, *Professional Remodeler*, and *Custom Builder* magazines

#### [www.buildiq.com](http://www.buildiq.com)

BuildIQ, a provider of online training for construction professionals, has an extensive resource list on best practices in homebuilding for consumers in its Best Practices area of this site.

#### [www.fypower.org/about/index.html](http://www.fypower.org/about/index.html)

Links to California utilities offering programs that can help builders meet ENERGY STAR standards. Some programs include financial incentives.

#### [www.northwestenergystar.com/index.php?cid=125](http://www.northwestenergystar.com/index.php?cid=125)

Information on the Northwest ENERGY STAR program for Oregon and Washington

# APPENDIX V: WEB SITE REFERENCES

---

## MANAGERS

---

[www.energystar.gov](http://www.energystar.gov)

ENERGY STAR is a government-backed program helping businesses and individuals protect the environment through superior energy efficiency.

[www.housingzone.com](http://www.housingzone.com)

Housingzone.com contains content for builders, remodelers, architects, suppliers, consumers, and manufacturers. The Web site includes material from *Professional Builder*, *Professional Remodeler*, and *Custom Builder* magazines

[www.energyvideos.com](http://www.energyvideos.com)

The California Energy Commission Web site contains brief videos explaining how building homes beyond the levels required by code is good for business. Other videos provide training on meeting California code and installing energy efficient building measures.

---

## MARKETERS

---

[www.energystar.gov](http://www.energystar.gov)

ENERGY STAR is a government-backed program helping businesses and individuals protect the environment through superior energy efficiency.

[www.nahrc.org/tertiaryR.asp?CategoryID=1705&DocumentID=3404](http://www.nahrc.org/tertiaryR.asp?CategoryID=1705&DocumentID=3404)

The *EnergyValue Housing Award* guide is a compilation of best practices of winners of the national EnergyValue Housing Award. It can be purchased from the NAHB Research Center Web site.

[www.efficientwindows.org/index.cfm](http://www.efficientwindows.org/index.cfm)

The Efficient Windows Collaborative Web site provides unbiased information on the benefits of energy-efficient windows, descriptions of how they work, and recommendations for their selection and use.

[www.builderonline.com/article-builder.asp?channelid=55&articleid=375&qu=consumer+survey](http://www.builderonline.com/article-builder.asp?channelid=55&articleid=375&qu=consumer+survey)

Builder Online Web site presents a survey that reveals builders and buyers may be on different wavelengths when it comes to the choice of products and materials.

[www.housingzone.com](http://www.housingzone.com)

Housingzone.com contains content for builders, remodelers, architects, suppliers, consumers, and manufacturers. The Web site includes material from *Professional Builder*, *Professional Remodeler*, and *Custom Builder* magazines

---

## SITE PLANNERS

---

[www.efficientwindows.org](http://www.efficientwindows.org)

The Efficient Windows Collaborative Web site provides unbiased information on the benefits of energy-efficient windows, descriptions of how they work, and recommendations for their selection and use.

[www.lid-stormwater.net](http://www.lid-stormwater.net)

Sponsored by the EPA, this Web site contains information and low-impact urban design tools to help developers and watershed managers.

[www.southface.org/home/sfpubs/large-pubs/Sustainable\\_community\\_development.pdf](http://www.southface.org/home/sfpubs/large-pubs/Sustainable_community_development.pdf)

Located in Atlanta, Southface Energy Institute is a 501(c)(3) nonprofit corporation that promotes sustainable homes, workplaces and communities through education, research, advocacy and technical assistance. This URL contains a PDF version of the referenced document.

[www.eeba.org](http://www.eeba.org)

The Energy and Environmental Building Association (EEBA) promotes the awareness, education and development of energy efficient, environmentally responsible buildings and communities. The EEBA Web site includes a bookstore where the referenced document may be purchased.

[www.fed.us/ne/newtown\\_square/publications/technical\\_reports/pdfs/scanned/gtr1869.pdf](http://www.fed.us/ne/newtown_square/publications/technical_reports/pdfs/scanned/gtr1869.pdf)

PDF version of the *Chicago's Urban Forest Ecosystem: Results of the Chicago Urban Forest Climate Project* from the U.S. Department of Agriculture's Northeastern Research Station.

[www.BuilderBooks.com](http://www.BuilderBooks.com)

Purchasing Web site of books for the builder, bookstore of the National Association of Home Builders.

[www.SBICouncil.org](http://www.SBICouncil.org)

Sustainable Buildings Industry Council (SBIC) is an independent, nonprofit organization whose mission is to advance the design, affordability, energy performance, and environmental soundness of America's buildings.

[www.fsec.ucf.edu/bldg/pubs/pf363/index.htm](http://www.fsec.ucf.edu/bldg/pubs/pf363/index.htm)

The Florida Solar Energy Center presents an article on housing in rural areas that could result in changes to local climate and increased energy bills.

[www.lid-stormwater.net](http://www.lid-stormwater.net)

Sponsored by the EPA, this Web site contains information and low-impact urban design tools to help developers and watershed managers.

# APPENDIX V: WEB SITE REFERENCES

[www.cabq.gov/waterconservation/xeric.html](http://www.cabq.gov/waterconservation/xeric.html)

The City of Albuquerque's Web site provides information on xeriscaping strategies for dry climates.

<http://xeriscape.org>

Xeriscape Colorado, Inc. is a non-profit membership group promoting creative approaches to water conserving landscapes.

[www.sustainabledesignguide.umn.edu/MSDG/site.html](http://www.sustainabledesignguide.umn.edu/MSDG/site.html)

A guide to sustainable development developed by the University of Minnesota.

<http://hort.ufl.edu>

A guide to environmentally friendly landscaping developed by the University of Florida.

[www.cagreenbuilder.org](http://www.cagreenbuilder.org)

California Green Builder: A homebuilders association

[www.stopwaste.org/fsbuild.html](http://www.stopwaste.org/fsbuild.html)

Green Building in Alameda County:  
A local government program.

[www.sfenvironment.org](http://www.sfenvironment.org)

San Francisco Department of Environment, Green Building:  
A local government program.

[www.silcom.com/~sbcplan/ibdrc.html](http://www.silcom.com/~sbcplan/ibdrc.html)

Innovative Building Review Program Santa Barbara County: A local government program.

[www.earthadvantage.com](http://www.earthadvantage.com)

Earth Advantage®: A non profit organization.

[www.green-rated.org](http://www.green-rated.org)

G/Rated Green Building Incentive Program:  
A local government program.

[www.builtgreen.net](http://www.builtgreen.net)

Built Green of King and Snohomish Counties:  
A homebuilders association.

[www.cityofseattle.net/sustainablebuilding/](http://www.cityofseattle.net/sustainablebuilding/)

Seattle Sustainable Building: A local government program

[www.kitsaphba.com/bbk.html](http://www.kitsaphba.com/bbk.html)

Built Green Kitsap: A homebuilders association

[www.builtgreennw.com/index.asp](http://www.builtgreennw.com/index.asp)

Built Green of Southwestern Washington:  
A homebuilders association.

[www.mbapierce.com](http://www.mbapierce.com)

Tacoma-Pierce County Built Green:  
A homebuilders association.

---

## DESIGNERS

---

### Building Science and the Systems Approach

[www.buildingamerica.gov](http://www.buildingamerica.gov)

Building America is a private/public partnership that develops energy solutions for new and existing homes.

[www.fsec.ucf.edu/bldg/science/basics/index.htm](http://www.fsec.ucf.edu/bldg/science/basics/index.htm)

The Florida Solar Energy Center presents the basics of building science for more efficient and powerful products.

[www.nbnnews.com](http://www.nbnnews.com)

National Association of Home Builders offers an online newsletter center with a tool for accessing back issues of the publications.

[www.natresnet.org](http://www.natresnet.org)

The Residential Energy Services Network's (RESNET) mission is to improve the energy efficiency of the nation's housing stock and to qualify more families for home ownership by expanding the national availability of mortgage financing options and home energy ratings.

[www.energycodes.gov](http://www.energycodes.gov)

A Web site describing U.S. DOE's Energy Codes Program.

[www.ibacos.com/bestprac.html](http://www.ibacos.com/bestprac.html)

IBACOS, a Building America team member, offers guidelines, including graphic details, for designing and implementing quality construction practices, based on IBACOS' research and experience working in the field with builders.

### Site – Drainage, Pest Control, and Landscaping

[www.uky.edu/Agriculture/Entomology/entfacts.htm](http://www.uky.edu/Agriculture/Entomology/entfacts.htm)

University of Kentucky Entomology site has a block of options to navigate which include field crops, fruit, livestock, misc., landscape plants, vegetables, home and health and a list of facts.

[www.eere.energy.gov/consumerinfo/your\\_home/landscaping/index.cfm/mytopic=11910](http://www.eere.energy.gov/consumerinfo/your_home/landscaping/index.cfm/mytopic=11910)

This Department of Energy's Web site includes information for energy efficiency landscaping.

# APPENDIX V: WEB SITE REFERENCES

## Foundation Measures

[www.epa.gov/radon/images/buildradonout.pdf](http://www.epa.gov/radon/images/buildradonout.pdf)

A guide to building radon-resistant homes is outlined by the Office of Radiation and Indoor Air at the U.S. Environmental Protection Agency.

[www.epa.gov/radon/zonemap.html](http://www.epa.gov/radon/zonemap.html)

Environmental Protection Agency's map of radon zones includes all states with a breakdown of zone information classified by region.

[www.epa.gov/iaq/wherelive.html](http://www.epa.gov/iaq/wherelive.html)

State and regional contact information for indoor air quality and radon control.

[www.buildingscience.com/resources/articles/24-27\\_Yost\\_for\\_author.pdf](http://www.buildingscience.com/resources/articles/24-27_Yost_for_author.pdf)

An Article by Dr. Nathan Yost, M.D. is presented by buildingscience.com and offers information on conditioned, unvented crawl spaces.

[www.buildingscience.com/designsthatwork/hothumid/profiles/montgomery.htm](http://www.buildingscience.com/designsthatwork/hothumid/profiles/montgomery.htm)

The Building Science Corporation leads a Building America team. Designs That Work provides drawings, specifications, materials characteristics for sample housing types in five climate zones.

[www.ibacos.com/qhome/Aug04/Aug2004\\_Water.html](http://www.ibacos.com/qhome/Aug04/Aug2004_Water.html)

This article from IBACOS discusses best practices for foundations in areas with expansive soils.

[www.ibacos.com/qhome/Jan04/Jan\\_BPWebBasements.html](http://www.ibacos.com/qhome/Jan04/Jan_BPWebBasements.html)  
[www.ibacos.com/qhome/Jan04/bestpractice.pdf](http://www.ibacos.com/qhome/Jan04/bestpractice.pdf)  
[www.ibacos.com/pubs/Newsletter-July02.pdf#page=3](http://www.ibacos.com/pubs/Newsletter-July02.pdf#page=3)

These articles from IBACOS present best practices for designing and building quality foundation systems.

## Structural Moisture Control

[www.eere.energy.gov/buildings/info/documents/pdfs/28600.pdf](http://www.eere.energy.gov/buildings/info/documents/pdfs/28600.pdf)

The Department of Energy presents a Technology Fact Sheet on how to select and install housewrap and other types of weather-resistive barriers.

[www.fema.gov](http://www.fema.gov)

The Federal Emergency Management Agency's mission is to prepare the nation for all hazards and effectively manage federal response and recovery efforts following any national incident.

[www.blueprintforsafety.org](http://www.blueprintforsafety.org)

Florida Alliance for Safe Homes' building guidelines for hazardous areas.

[www.ibhs.org](http://www.ibhs.org)

The Institute for Business and Home Safety has building guidelines and public information for surviving disasters.

[www.buildingcodeonline.com](http://www.buildingcodeonline.com)

The Miami-Dade County Building Code Compliance Office offers a searchable database of building materials approved for high-wind locations.

[www.ibacos.com/pubs/RoofFlashingGuidelines.pdf](http://www.ibacos.com/pubs/RoofFlashingGuidelines.pdf)

This document provides guidelines on roof flashing.

[www.ibacos.com/qhome/Aug03/Sug2003\\_bp\\_brick.html](http://www.ibacos.com/qhome/Aug03/Sug2003_bp_brick.html)

This article by IBACOS provides solutions for moisture issues in brick veneer homes.

[www.ibacos.com/qhome/Winter05/winter05\\_bestpractices\\_drainage\\_plane.html](http://www.ibacos.com/qhome/Winter05/winter05_bestpractices_drainage_plane.html)

This article by IBACOS discusses the importance of providing a continuous drainage plane.

[www.eere.energy.gov/weatherization/hazard\\_workshop.html](http://www.eere.energy.gov/weatherization/hazard_workshop.html)

U.S. DOE offers a training program for home inspectors to identify hazards.

[www.buildingscience.com/resources/walls/brick\\_stucco\\_housewraps.pdf](http://www.buildingscience.com/resources/walls/brick_stucco_housewraps.pdf)

Website provides information on housewrap and building paper performance behind brick and stucco.

[www.buildingscience.com/designsthatwork/buildingmaterials.htm](http://www.buildingscience.com/designsthatwork/buildingmaterials.htm)

The Building Science Corporation leads a Building America team. Designs That Work provides drawings, specifications, materials characteristics for sample housing types in five climate zones.

[www.buildingscience.com/resources/walls/problems\\_with\\_housewraps.htm](http://www.buildingscience.com/resources/walls/problems_with_housewraps.htm)

The function of a housewrap and the problems associated with them are laid out in a well written article on buildingscience.com.

# APPENDIX V: WEB SITE REFERENCES

[www.cdnarchitect.com](http://www.cdnarchitect.com)

*Canadian Architect* is a magazine that offers information for architects and other professionals in related fields.

[www.nahbrc.org/docs/mainnav/moistureandleaks/792\\_moisture.pdf](http://www.nahbrc.org/docs/mainnav/moistureandleaks/792_moisture.pdf)

This document from the NAHB Research Center provides information to help control leaks.

[www.eeba.org/bookstore](http://www.eeba.org/bookstore)

The Energy and Environmental Building Association (EEBA) promotes the awareness, education and development of energy efficient, environmentally responsible buildings and communities. The EEBA Web site includes a bookstore where the referenced document may be purchased.

[www.buildingscience.com/designsthatwork/airsealing/default.htm](http://www.buildingscience.com/designsthatwork/airsealing/default.htm)

The Building Science Corporation leads a Building America team. *Designs That Work* provides drawings, specifications, materials characteristics for sample housing types in five climate zones.

[www.eere.energy.gov/buildings/info/documents/pdfs/26448.pdf](http://www.eere.energy.gov/buildings/info/documents/pdfs/26448.pdf)

The Department of Energy presents a Technology Fact Sheet on the benefits of sealing air leaks to save energy.

## Structural Thermal Performance

[www.ornl.gov/sci/roofs+walls/insulation/ins\\_08.html](http://www.ornl.gov/sci/roofs+walls/insulation/ins_08.html)

What kind of insulation should you buy? An insulation fact sheet presented by the Department of Energy clarifies.

[www.fsec.ucf.edu/bldg/pubs/rbs/index.htm](http://www.fsec.ucf.edu/bldg/pubs/rbs/index.htm)

The FPC Monitoring project has evaluated radiant barrier systems (RBS) as a new potential DSM program.

[www.ornl.gov/sci/roofs+walls/radiant/rb\\_01.html](http://www.ornl.gov/sci/roofs+walls/radiant/rb_01.html)

Provides descriptions and a fact sheet about radiant barriers.

[www.energystar.gov](http://www.energystar.gov)

ENERGY STAR is a government-backed program helping businesses and individuals protect the environment through superior energy efficiency.

[www.ornl.gov/sci/roofs+walls/insulation/ins\\_16.html](http://www.ornl.gov/sci/roofs+walls/insulation/ins_16.html)

Easy to use R-Value recommendation form uses input such as house status, fuel type and zip code to form analysis for installation.

[www.eere.energy.gov/consumerinfo/energy\\_savers/r-value\\_map.html](http://www.eere.energy.gov/consumerinfo/energy_savers/r-value_map.html)

A detailed map represents recommended total R-Values for existing houses according to the Department of Energy.

[www.buildingscience.com/designsthatwork/advancedframing/default.htm](http://www.buildingscience.com/designsthatwork/advancedframing/default.htm)

Advanced framing details the Building Science Corporation.

[www.buildingscience.com/designsthatwork/hothumid/profiles/orlando.htm](http://www.buildingscience.com/designsthatwork/hothumid/profiles/orlando.htm)

The Building Science Corporation leads a Building America team. Designs That Work provides drawings, specifications, materials characteristics for sample housing recommendations in five climate zones.

[www.nfrc.org](http://www.nfrc.org)

National Fenestration Rating Council (NFRC) is a non-profit, public/private organization created by the window, door and skylight industry which provides consistent ratings on window, door and skylight products.

[www.efficientwindows.org/index.cfm](http://www.efficientwindows.org/index.cfm)

The Efficient Windows Collaborative Web site provides unbiased information on the benefits of energy-efficient windows, descriptions of how they work, and recommendations for their selection and use.

[www.susdesign.com/sunangle/](http://www.susdesign.com/sunangle/)

Input and output variables form a calculation tool for sun angles.

[www.wunderground.com](http://www.wunderground.com)

A weather forecasting and data Web site.

[www.susdesign.com/overhang/index.html](http://www.susdesign.com/overhang/index.html)

Overhang design tool allows the shading performance of window overhangs to be easily analyzed using precise calculations and positioning.

[www.eere.energy.gov/buildings/tools\\_directory/](http://www.eere.energy.gov/buildings/tools_directory/)

DOE's Building Technologies Program works to improve the energy efficiency of our nation's buildings through innovative new technologies and better building practices. Site includes research and regulatory activities.

[www.sbse.org/resources/sac/index.htm](http://www.sbse.org/resources/sac/index.htm)

Presented by the Society of Building Science Educators, this Web page offers general information and purchasing details on the sun angle calculator.

[www.ibacos.com/qhome/March04/Mar\\_BPRoofs.html](http://www.ibacos.com/qhome/March04/Mar_BPRoofs.html)

This article by IBACOS discusses best practices for an airtight, insulated roof system, and provides specific solutions insulating cathedral roofs.

# APPENDIX V: WEB SITE REFERENCES

[www.ibacos.com/qhome/March04/Mar\\_Tech\\_VentedAttics.html](http://www.ibacos.com/qhome/March04/Mar_Tech_VentedAttics.html)

This article by IBACOS discusses insulating vented attics for performance.

[www.ibacos.com/qhome/Oct03/duct.html](http://www.ibacos.com/qhome/Oct03/duct.html)

This article by IBACOS discusses controlling condensation on duct systems.

## Heating, Ventilating and Air Conditioning

[www.acca.org](http://www.acca.org)

From technical topics to management tips, the Air Conditioning Contractors of America provide a wealth of knowledge and information useful for the successful contracting business, including selection and sizing manuals.

[www.energy.ca.gov/2005publications/CEC-400-2005-005/CEC-400-2005-005-CMF.pdf](http://www.energy.ca.gov/2005publications/CEC-400-2005-005/CEC-400-2005-005-CMF.pdf)

California Energy Commission's 2005 Residential Compliance Manual

[www.eere.energy.gov/buildings/appliance\\_standards/](http://www.eere.energy.gov/buildings/appliance_standards/)  
DOE's tips on saving energy and money at home.

[www.energystar.gov/index.cfm?c=appliances.pr\\_appliances](http://www.energystar.gov/index.cfm?c=appliances.pr_appliances)

A list of appliances with an ENERGY STAR rating can be found on this Web page.

[www.buildingscience.com/resources/mechanical/fancyling/air\\_distribution.pdf](http://www.buildingscience.com/resources/mechanical/fancyling/air_distribution.pdf)

Examples of HVAC systems with detailed information on the energy and economic benefit is provided by buildingscience.com.

[www.ibacos.com/pubs/Newsletter-July02.pdf](http://www.ibacos.com/pubs/Newsletter-July02.pdf)

This article by IBACOS discusses best practices for achieving thermal comfort.

[www.ibacos.com/qhome/March03/march03\\_cover.html](http://www.ibacos.com/qhome/March03/march03_cover.html)

This article by IBACOS presents HVAC optimization strategies.

[www.ibacos.com/qhome/June03/wtrhtr.html](http://www.ibacos.com/qhome/June03/wtrhtr.html)

This article by IBACOS discusses sizing strategies for water heaters.

[www.buildingscience.com/resources/mechanical/conditioning\\_air.pdf](http://www.buildingscience.com/resources/mechanical/conditioning_air.pdf)

The Building Science Consortium's Houston study of dehumidifiers (BSC 2002) is available on the referenced Web page.

<http://ducts.lbl.gov/Publications/lbl-41118.pdf>

A technical report on duct sealants can be found on the referenced Web page.

[www.homeenergy.org/archive/hem.dis.anl.gov/eehem/98/9807.html](http://www.homeenergy.org/archive/hem.dis.anl.gov/eehem/98/9807.html)

The magazine, *Home Energy*, contains an article describing duct sealants.

[www.fsec.ucf.edu/bldg/baihp//pubs/interior\\_ducts.pdf](http://www.fsec.ucf.edu/bldg/baihp//pubs/interior_ducts.pdf)

Web page offers information on designing and building an interior chase.

[www.buildingscience.com/resources/roofs/unvented\\_roof\\_summary\\_article.pdf](http://www.buildingscience.com/resources/roofs/unvented_roof_summary_article.pdf)

The linked article summarizes the various papers on unvented conditioned cathedralized attics found on the site.

[www.buildingscience.com/designsthatwork/hothumid/profiles/montgomery.htm](http://www.buildingscience.com/designsthatwork/hothumid/profiles/montgomery.htm)

The Building Science Corporation leads a Building America team. Designs That Work provides drawings, specifications, materials characteristics for sample housing types in five climate zones.

[www.energystar.gov/ia/new\\_homes/features/DuctInsulation1-17-01.pdf](http://www.energystar.gov/ia/new_homes/features/DuctInsulation1-17-01.pdf)

Recommendations for insulation levels for ducts in unconditioned spaces can be found on this site.

[www.buildingscience.com/resources/moisture/relative\\_humidity\\_0402.pdf](http://www.buildingscience.com/resources/moisture/relative_humidity_0402.pdf)

Relative humidity discussion.

## Mechanicals Management and Appliances

[www.toolbase.org](http://www.toolbase.org)

This Web site contains PATH's listing of building technologies, including air admittance vents and manifold water distribution systems. PATH stands for the Partnership for Advanced Housing Technology. To reach information about air admittance valves after reaching the Web site select new building technologies, plumbing, distribution systems, and finally, air admittance vents.



# APPENDIX V: WEB SITE REFERENCES

## [www.gamanet.org](http://www.gamanet.org)

GAMA, the Gas Appliance Manufacturers Association, is a national trade association of manufacturers of residential, commercial and industrial appliances and equipment, components and related products.

## [www.energy.state.or.us/res/tax/appheat.htm](http://www.energy.state.or.us/res/tax/appheat.htm)

A list of high-efficiency water heaters that qualify for state tax credits is presented by The Oregon Department of Energy. Only Oregon taxpayers qualify for the credits.

## [www.pnl.gov/cfldownlights/](http://www.pnl.gov/cfldownlights/)

The purpose of the Residential Recessed Downlights Project is to increase the availability and use of highly energy-efficient recessed downlight fixtures for homes. Website provides highly energy-efficient recessed downlight fixtures that have undergone stringent testing available for purchase.

## [www.eere.energy.gov/consumerinfo/energy\\_savers/appliances.html](http://www.eere.energy.gov/consumerinfo/energy_savers/appliances.html)

A list of major appliances with high-energy efficiency standards are documented by the Department of Energy. Only appliances in the top one-third of the DOE Energy Guide rating scale should be selected.

## [www.ibacos.com/hpl.html](http://www.ibacos.com/hpl.html)

Designed for builders, this High Performance Lighting Guide developed by IBACOS discusses high performance lighting strategies for new homes.

## Web Sites Listed Only in Designers Chapter References

## [www.buildingscience.com/resources/mechanical/advanced\\_space\\_conditioning.pdf](http://www.buildingscience.com/resources/mechanical/advanced_space_conditioning.pdf)

A Building Science Corporation document discussing system tradeoffs between building envelopes and heating and ventilation equipment.

## [www.buildingamerica.gov](http://www.buildingamerica.gov)

Building America is a private/public partnership that develops energy solutions for new and existing homes.

## [www.wwnorton.com/npb/welcome.htm](http://www.wwnorton.com/npb/welcome.htm)

Norton Professional Books offers an online bookstore in subjects such as architecture/design.

## [www.nrel.gov/docs/fy01osti/28600.pdf](http://www.nrel.gov/docs/fy01osti/28600.pdf)

The Department of Energy presents a Technology Fact Sheet on how to select and install housewrap and other types of weather-resistive barriers.

## [www.eeba.org/bookstore](http://www.eeba.org/bookstore)

The Energy and Environmental Building Association (EEBA) promotes the awareness, education and development of energy efficient, environmentally responsible buildings and communities. The EEBA Web site includes a bookstore where the referenced document may be purchased.

## [www.fsec.ucf.edu/bldg/baihp/pubs/interior\\_ducts.pdf](http://www.fsec.ucf.edu/bldg/baihp/pubs/interior_ducts.pdf)

Web page offers information on designing and building an interior chase.

## [www.fsec.ucf.edu/bldg/pubs/rbs/index.htm](http://www.fsec.ucf.edu/bldg/pubs/rbs/index.htm)

The FPC Monitoring project has evaluated radiant barrier systems (RBS) as a new potential DSM program.

## [www.buildingscience.com/resources/mechanical/air\\_conditioning\\_equipment\\_efficiency.pdf](http://www.buildingscience.com/resources/mechanical/air_conditioning_equipment_efficiency.pdf)

A Building Science Corporation document providing procedures for refrigeration system installation and start up.

## [www.homeenergy.org/898ducttape.title.html](http://www.homeenergy.org/898ducttape.title.html)

*Home Energy Magazine* contains an article describing duct sealants.

## [www.SBICouncil.org](http://www.SBICouncil.org)

Sustainable Buildings Industry Council (SBIC) is an independent, nonprofit organization whose mission is to advance the design, affordability, energy performance, and environmental soundness of America's buildings.

## [www.energystar.gov/ia/new\\_homes/features/DuctInsulation1-17-01.pdf](http://www.energystar.gov/ia/new_homes/features/DuctInsulation1-17-01.pdf)

Recommendations for insulation levels for ducts in unconditioned spaces in the hot and humid climate can be found on this site.

## [www.fsec.ucf.edu/bldg/pubs/ACsize/index.htm](http://www.fsec.ucf.edu/bldg/pubs/ACsize/index.htm)

The Florida Solar Energy Center presents a document on how air conditioning systems are sized.

## <http://ducts.lbl.gov/Publications/lbl-41118.pdf>

A technical report on duct sealants can be found on the referenced Web page.

## [www.buildingscience.com/resources/articles/24-27\\_Yost\\_for\\_author.pdf](http://www.buildingscience.com/resources/articles/24-27_Yost_for_author.pdf)

An Article by Dr. Nathan Yost, M.D. is presented by buildingscience.com and offers information on conditioned, unvented crawl spaces.

# APPENDIX V: WEB SITE REFERENCES

[www.eere.energy.gov/buildings/tools\\_directory/](http://www.eere.energy.gov/buildings/tools_directory/)

DOE's Building Technologies Program works to improve the energy efficiency of our nation's buildings through innovative new technologies and better building practices. Site includes research and regulatory activities.

[www.energystar.gov/index.cfm?c=bop.pt\\_bop\\_index](http://www.energystar.gov/index.cfm?c=bop.pt_bop_index)

ENERGY STAR is a government-backed program helping businesses and individuals protect the environment through superior energy efficiency. Index includes builder option packages referenced by state.

---

## SITE SUPERVISORS

---

[www.comfortwise.com/installationprotocols.shtml](http://www.comfortwise.com/installationprotocols.shtml)

ConSol leads a Building America team and developed the statements of work listed on this Web site for builders in California. These statements of work can be incorporated into contracts.

[www.thebii.org/rpsw.asp](http://www.thebii.org/rpsw.asp)

Statements of work developed by ConSol for builders in California are also available on this Web site. These statements of work can be incorporated into contracts.

[www.energycodes.gov/support/code-notes.stm](http://www.energycodes.gov/support/code-notes.stm)

DOE's building codes program provides draft Code Notes to help code officials

[www.buildingamerica.gov](http://www.buildingamerica.gov)

Building America is a private/public partnership that develops energy solutions for new and existing homes.

[www.eeba.org](http://www.eeba.org)

The Energy and Environmental Building Association (EEBA) promotes the awareness, education and development of energy efficient, environmentally responsible buildings and communities. The EEBA Web site includes a bookstore where the referenced document may be purchased.

[www.buildingscience.com/workshops/default.htm](http://www.buildingscience.com/workshops/default.htm)

Building Science Corporation offers workshops and seminars that are tailored towards building professionals.

[www.nahbrc.org](http://www.nahbrc.org)

The National Association of Home Builders Research Center leads a Building America team and conducts training for builders. This Web site contains articles, schedules, and links describing technical materials and training opportunities.

[www.southface.org](http://www.southface.org)

Located in Atlanta, Southface Energy Institute is a 501(c)(3) nonprofit corporation that promotes sustainable homes, workplaces and communities through education, research, advocacy and technical assistance.

[www.ibacos.com](http://www.ibacos.com)

IBACOS, Inc. (Integrated Building and Construction Solutions) was created to help enable the homebuilding industry to deliver Quality Homes®—homes of inherently higher performance that are safe, healthy, durable, comfortable and efficient.

[www.acca.org](http://www.acca.org)

From technical topics to management tips, the Air Conditioning Contractors of America provide a wealth of knowledge and information useful for the successful contracting business, including selection and sizing manuals.

[www.installationmastersusa.com](http://www.installationmastersusa.com)

This Web site describes a window installation training program developed by the American Architectural Manufacturers Association.

[www.energyvideos.com](http://www.energyvideos.com)

The California Energy Commission Web site contains brief videos explaining how building homes beyond the levels required by code is good for business. Other videos provide training on meeting California code and installing energy efficient building measures.

[www.pathnet.org/sp.asp?id=10787](http://www.pathnet.org/sp.asp?id=10787)

This Web site contains training videos available from PATH TV. PATH stands for the Partnership for Advancing Technology in Housing.

[www.natresnet.org](http://www.natresnet.org)

The Residential Energy Services Network's (RESNET) mission is to improve the energy efficiency of the nation's housing stock and to qualify more families for home ownership by expanding the national availability of mortgage financing options and home energy ratings.

<http://hem.dis.anl.gov/eehem/00/001105.html>

*Home Energy Magazine* explores HVAC questions.

# APPENDIX V: WEB SITE REFERENCES

---

## TRADES

---

### Slab Insulation - Marine Climate

[www.eere.energy.gov/buildings/info/documents/pdfs/29237.pdf](http://www.eere.energy.gov/buildings/info/documents/pdfs/29237.pdf)

The Department of Energy presents a Technology Fact Sheet on how to improve comfort and save energy in homes with slab-on-grade floors.

[www.epa.gov/199/iaq/radon](http://www.epa.gov/199/iaq/radon)

A guide to building radon-resistant homes is outlined by the Office of Radiation and Indoor Air at the U.S. Environmental Protection Agency.

[www.southface.org/web/resources&services/publications/factsheets/29\\_insulatefloors4PDF.pdf](http://www.southface.org/web/resources&services/publications/factsheets/29_insulatefloors4PDF.pdf)

Located in Atlanta, Southface Energy Institute is a 501(c)(3) nonprofit corporation that promotes sustainable homes, workplaces and communities through education, research, advocacy and technical assistance. This URL contains a PDF version of the referenced document.

[www.southface.org/web/resources&services/publications/factsheets/30\\_radonresistantconst.pdf](http://www.southface.org/web/resources&services/publications/factsheets/30_radonresistantconst.pdf)

Located in Atlanta, Southface Energy Institute is a 501(c)(3) nonprofit corporation that promotes sustainable homes, workplaces and communities through education, research, advocacy and technical assistance. This URL contains a PDF version of the referenced document.

[www.buildingscience.com/designsthatwork](http://www.buildingscience.com/designsthatwork)

The Building Science Corporation leads a Building America team. *Designs that Work* provides drawings, specifications, materials characteristics for sample housing types in five climate zones.

### Basement & Conditioned (Unvented) Crawlspace Insulation

[www.buidingamerica.gov](http://www.buidingamerica.gov)

Building America is a private/public partnership that develops energy solutions for new and existing homes.

[www.eeba.org/bookstore](http://www.eeba.org/bookstore)

The Energy and Environmental Building Association (EEBA) promotes the awareness, education and development of energy efficient, environmentally responsible buildings and communities. The EEBA Web site includes a bookstore where the referenced document may be purchased.

[www.epa.gov/199/iaq/radon](http://www.epa.gov/199/iaq/radon)

A guide to building radon-resistant homes is outlined by the Office of Radiation and Indoor Air at the U.S. Environmental Protection Agency.

### Housewraps

[www.southface.org/home/sfpubs/techshts/8\\_airsealing.pdf](http://www.southface.org/home/sfpubs/techshts/8_airsealing.pdf)

Located in Atlanta, Southface Energy Institute is a 501(c)(3) nonprofit corporation that promotes sustainable homes, workplaces and communities through education, research, advocacy and technical assistance. This URL contains a PDF version of the referenced document.

[www.eere.energy.gov/buildings/info/documents/pdfs/26448.pdf](http://www.eere.energy.gov/buildings/info/documents/pdfs/26448.pdf)

The Department of Energy presents a Technology Fact Sheet on the benefits of sealing air leaks to save energy.

<http://construction.tyvek.com/en/productServices/HomeWrap/index.shtml>

Tyvek® HomeWrap® is a weatherization membrane that provides a protective layer under a home's siding and over the sheathing.

[www.cdnarchitect.com](http://www.cdnarchitect.com)

*Canadian Architect* is a magazine that offers information for architects and other professionals in related fields.

### Window Flashing

[www.eeba.org](http://www.eeba.org)

The Energy and Environmental Building Association (EEBA) promotes the awareness, education and development of energy efficient, environmentally responsible buildings and communities. The EEBA Web site includes a bookstore where the referenced document may be purchased.

[www.eere.energy.gov/buildings/info/documents/pdfs/28600.pdf](http://www.eere.energy.gov/buildings/info/documents/pdfs/28600.pdf)

The Department of Energy presents a Technology Fact Sheet on how to select and install housewrap and other types of weather-resistive barriers.

[www.ibacos.com/qhome/Jan03/jan03\\_windows.html](http://www.ibacos.com/qhome/Jan03/jan03_windows.html)

This document from IBACOS present window flashing and installation guidelines.

# APPENDIX V: WEB SITE REFERENCES

## Air Sealing – Plumbing

[www.eeba.org](http://www.eeba.org)

The Energy and Environmental Building Association (EEBA) promotes the awareness, education and development of energy efficient, environmentally responsible buildings and communities. The EEBA Web site includes a bookstore where the referenced document may be purchased.

[www.eere.energy.gov/buildings/info/documents/pdfs/26448.pdf](http://www.eere.energy.gov/buildings/info/documents/pdfs/26448.pdf)

The Department of Energy presents a Technology Fact Sheet on the **benefits of sealing air leaks to save energy**.

[www.toolbase.org](http://www.toolbase.org)

This Web site contains PATH's listing building technologies, including air admittance vents and manifold water distribution systems. PATH stands for the Partnership for Advanced Housing Technology. To reach information about air admittance valves after reaching the Web site select new building technologies, plumbing, distribution systems, and finally, air admittance vents.

## Electrical Air Sealing

[www.eeba.org](http://www.eeba.org)

The Energy and Environmental Building Association (EEBA) promotes the awareness, education and development of energy efficient, environmentally responsible buildings and communities. The EEBA Web site includes a bookstore where the referenced document may be purchased.

[www.eere.energy.gov/buildings/info/documents/pdfs/26448.pdf](http://www.eere.energy.gov/buildings/info/documents/pdfs/26448.pdf)

The Department of Energy presents a Technology Fact Sheet on the **benefits of sealing air leaks to save energy**.

## Air Sealing Glossary

[www.eere.energy.gov/buildings/info/documents/pdfs/26448.pdf](http://www.eere.energy.gov/buildings/info/documents/pdfs/26448.pdf)

The Department of Energy presents a Technology Fact Sheet on the **benefits of sealing air leaks to save energy**.

## Masonry Construction

[www.eeba.org](http://www.eeba.org)

The Energy and Environmental Building Association (EEBA) promotes the awareness, education and development of energy efficient, environmentally responsible buildings and communities. The EEBA Web site includes a bookstore where the referenced document may be purchased.

## Radiant Barriers

[www.eere.energy.gov/consumerinfo/refbriefs/bc7.html](http://www.eere.energy.gov/consumerinfo/refbriefs/bc7.html)

The Department of Energy presents an information fact sheet on radiant barriers.

[www.southface.org/home/sfpubs/techshts/14radiantbarriers.pdf](http://www.southface.org/home/sfpubs/techshts/14radiantbarriers.pdf)

Located in Atlanta, Southface Energy Institute is a 501(c)(3) nonprofit corporation that promotes sustainable homes, workplaces and communities through education, research, advocacy and technical assistance. This URL contains a PDF version of the referenced document.

[www.southface.org/home/sfpubs/techshts/25\\_insulateceilings\\_4pdf.pdf](http://www.southface.org/home/sfpubs/techshts/25_insulateceilings_4pdf.pdf)

Located in Atlanta, Southface Energy Institute is a 501(c)(3) nonprofit corporation that promotes sustainable homes, workplaces and communities through education, research, advocacy and technical assistance. This URL contains a PDF version of the referenced document.

## Duct Sealing

[www.southface.org/home/sfpubs/techshts/2duct\\_q&a.pdf](http://www.southface.org/home/sfpubs/techshts/2duct_q&a.pdf)

Located in Atlanta, Southface Energy Institute is a 501(c)(3) nonprofit corporation that promotes sustainable homes, workplaces and communities through education, research, advocacy and technical assistance. This URL contains a PDF version of the referenced document.

[www.southface.org/home/sfpubs/techshts/checklist.pdf](http://www.southface.org/home/sfpubs/techshts/checklist.pdf)

Located in Atlanta, Southface Energy Institute is a 501(c)(3) nonprofit corporation that promotes sustainable homes, workplaces and communities through education, research, advocacy and technical assistance. This URL contains a PDF version of the referenced document.

[www.ibacos.com/qhome/Oct03/bpflexduct.html](http://www.ibacos.com/qhome/Oct03/bpflexduct.html)

This document by IBACOS provides guidelines for connecting flex duct to duct board.

# APPENDIX V: WEB SITE REFERENCES

---

## APPENDIX I

---

No Web sites

## APPENDIX II

[www.fsec.ucf.edu/bldg/fyh/ratings/e\\_terms.htm](http://www.fsec.ucf.edu/bldg/fyh/ratings/e_terms.htm)

Terms and definitions for energy efficiency economics is offered in two organized lists: Energy-Efficiency, Code and Rating Terminology & Economic, Financial & Real Estate Terminology. Both lists are useful for Energy Raters to effectively perform their function as energy auditors.

[www.eeba.org](http://www.eeba.org)

The Energy and Environmental Building Association (EEBA) promotes the awareness, education and development of energy efficient, environmentally responsible buildings and communities. The EEBA Web site includes a bookstore where the referenced document may be purchased.

---

## APPENDIX III

---

[www.energycodes.gov/support/code-notes.stm](http://www.energycodes.gov/support/code-notes.stm)

DOE's building codes program provides draft Code Notes to help code officials

[www.eeba.org](http://www.eeba.org)

The Energy and Environmental Building Association (EEBA) promotes the awareness, education and development of energy efficient, environmentally responsible buildings and communities. The EEBA Web site includes a bookstore where the referenced document may be purchased.

[www.fsec.ucf.edu](http://www.fsec.ucf.edu)

Florida Solar Energy Center (FSEC), A Research Institute of the University of Central Florida, conducts research and develops energy technologies that enhance Florida's and the nation's economy and environment. FSEC also educates the public, students and practitioners on the results of the research.

[www.e-star.com](http://www.e-star.com)

E-Star Energy Ratings allow homeowners and builders to create energy-efficient homes that are economical, comfortable, and better for the environment.

# REPORT DOCUMENTATION PAGE

*Form Approved*  
OMB No. 0704-0188

The public reporting burden for this collection of information is estimated to average 1 hour per response, including the time for reviewing instructions, searching existing data sources, gathering and maintaining the data needed, and completing and reviewing the collection of information. Send comments regarding this burden estimate or any other aspect of this collection of information, including suggestions for reducing the burden, to Department of Defense, Executive Services and Communications Directorate (0704-0188). Respondents should be aware that notwithstanding any other provision of law, no person shall be subject to any penalty for failing to comply with a collection of information if it does not display a currently valid OMB control number.

**PLEASE DO NOT RETURN YOUR FORM TO THE ABOVE ORGANIZATION.**

<b>1. REPORT DATE (DD-MM-YYYY)</b> October 2006		<b>2. REPORT TYPE</b> Technical Report		<b>3. DATES COVERED (From - To)</b>		
<b>4. TITLE AND SUBTITLE</b> Building America Best Practices Series: Volume 5. Builders and Buyers Handbook for Improving New Home Efficiency, Comfort, and Durability in the Marine Climate			<b>5a. CONTRACT NUMBER</b> DE-AC36-99-GO10337			
			<b>5b. GRANT NUMBER</b>			
			<b>5c. PROGRAM ELEMENT NUMBER</b>			
<b>6. AUTHOR(S)</b> Michael C. Baechler, Z. Todd Taylor, Rosemarie Bartlett, Theresa Gilbride, Marye Hefty, Heidi Steward, Pat Love, Jannifer Palmer			<b>5d. PROJECT NUMBER</b> NREL/TP-550-38449			
			<b>5e. TASK NUMBER</b> BET6.8004			
			<b>5f. WORK UNIT NUMBER</b>			
<b>7. PERFORMING ORGANIZATION NAME(S) AND ADDRESS(ES)</b> National Renewable Energy Laboratory 1617 Cole Blvd. Golden, CO 80401-3393				<b>8. PERFORMING ORGANIZATION REPORT NUMBER</b> NREL/TP-550-38449		
<b>9. SPONSORING/MONITORING AGENCY NAME(S) AND ADDRESS(ES)</b>				<b>10. SPONSOR/MONITOR'S ACRONYM(S)</b> NREL		
				<b>11. SPONSORING/MONITORING AGENCY REPORT NUMBER</b>		
<b>12. DISTRIBUTION AVAILABILITY STATEMENT</b> National Technical Information Service U.S. Department of Commerce 5285 Port Royal Road Springfield, VA 22161						
<b>13. SUPPLEMENTARY NOTES</b>						
<b>14. ABSTRACT (Maximum 200 Words)</b> This best practices guide is part of a series produced by Building America. The guide book is a resource to help builders large and small build high-quality, energy-efficient homes that achieve 30% energy savings in space conditioning and water heating in the marine climate region. The savings are in comparison with the 1993 Model Energy Code. The guide contains chapters for every member of the builder's team—from the manager to the site planner to the designers, site supervisors, the trades, and marketers. There is also a chapter for homeowners on how to use the book to provide help in selecting a new home or builder.						
<b>15. SUBJECT TERMS</b> Building America; Marine climate region; U.S. Department of Energy; energy-efficient houses; home comfort; house durability						
<b>16. SECURITY CLASSIFICATION OF:</b>			<b>17. LIMITATION OF ABSTRACT</b> UL	<b>18. NUMBER OF PAGES</b>	<b>19a. NAME OF RESPONSIBLE PERSON</b>	
<b>a. REPORT</b> Unclassified	<b>b. ABSTRACT</b> Unclassified	<b>c. THIS PAGE</b> Unclassified			<b>19b. TELEPHONE NUMBER (Include area code)</b>	

Standard Form 298 (Rev. 8/98)  
Prescribed by ANSI Std. Z39.18

## A Strong Energy Portfolio for a Strong America

Energy efficiency and clean, renewable energy will mean a stronger economy, a cleaner environment, and greater energy independence for America. Working with a wide array of state, community, industry, and university partners, the U.S. Department of Energy's Office of Energy Efficiency and Renewable Energy invests in a diverse portfolio of energy technologies.

## Research and Development of Buildings

Our nation's buildings consume more energy than any other sector of the U.S. economy, including transportation and industry. Fortunately, the opportunities to reduce building energy use—and the associated environmental impacts—are significant.

DOE's Building Technologies Program works to improve the energy efficiency of our nation's buildings through innovative new technologies and better building practices. The program focuses on two key areas:

### • Emerging Technologies

Research and development of the next generation of energy-efficient components, materials, and equipment

### • Technology Integration

Integration of new technologies with innovative building methods to optimize building performance and savings

For more information contact:  
EERE Information Center  
1-877-EERE-INF (1-877-337-3463)  
[www.eere.energy.gov](http://www.eere.energy.gov)



U.S. Department of Energy  
**Energy Efficiency  
and Renewable Energy**

An electronic copy of this publication is available on the Building America Web site at [www.buildingamerica.gov](http://www.buildingamerica.gov)

## Visit our Web sites at:

[www.buildingamerica.gov](http://www.buildingamerica.gov)

[www.pathnet.org](http://www.pathnet.org)

[www.energystar.gov](http://www.energystar.gov)



### Building America Program

George S. James • New Construction • 202-586-9472 • fax: 202-586-8134 • e-mail: [George.James@ee.doe.gov](mailto:George.James@ee.doe.gov)  
Terry Logee • Existing Homes • 202-586-1689 • fax: 202-586-4617 • e-mail: [terry.logee@ee.doe.gov](mailto:terry.logee@ee.doe.gov)  
Lew Pratsch • Integrated Onsite Power • 202-586-1512 • fax: 202-586-8185 • e-mail: [Lew.Pratsch@hq.doe.gov](mailto:Lew.Pratsch@hq.doe.gov)  
Building America Program • Office of Building Technologies, EE-2J • U.S. Department of Energy • 1000 Independence Avenue, S.W. • Washington, D.C. 20585-0121 • [www.buildingamerica.gov](http://www.buildingamerica.gov)

### Building Industry Research Alliance (BIRA)

Robert Hammon • ConSol • 7407 Tam O'Shanter Drive #200 • Stockton, CA 95210-3370 • 209-473-5000 • fax: 209-474-0817 • e-mail: [Rob@consol.ws](mailto:Rob@consol.ws) • [www.bira.ws](http://www.bira.ws)

### Building Science Consortium (BSC)

Betsy Pettit • Building Science Consortium (BSC) • 70 Main Street • Westford, MA 01886 • 978-589-5100 • fax: 978-589-5103 • e-mail: [Betsy@buildingscience.com](mailto:Betsy@buildingscience.com) • [www.buildingscience.com](http://www.buildingscience.com)

### Consortium for Advanced Residential Buildings (CARB)

Steven Winter • Steven Winter Associates, Inc. • 50 Washington Street • Norwalk, CT 06854 • 203-857-0200 • fax: 203-852-0741 • e-mail: [swinter@swinter.com](mailto:swinter@swinter.com) • [www.carb-swa.com](http://www.carb-swa.com)

### Davis Energy Group

David Springer • Davis Energy Group • 123 C Street • Davis, CA 95616 • 530-753-1100 • fax: 530-753-4125 • e-mail: [springer@davisenergy.com](mailto:springer@davisenergy.com) • [deg@davisenergy.com](mailto:deg@davisenergy.com) • [www.davisenergy.com/index.html](http://www.davisenergy.com/index.html)

### IBACOS Consortium

Brad Oberg • IBACOS Consortium • 2214 Liberty Avenue • Pittsburgh, PA 15222 • 412-765-3664 • fax: 412-765-3738 • e-mail: [boberg@ibacos.com](mailto:boberg@ibacos.com) • [www.ibacos.com](http://www.ibacos.com)

### Industrialized Housing Partnership (IHP)

Subrato Chandra • Florida Solar Energy Center • 1679 Clearlake Road • Cocoa, FL 32922 • 321-638-1412 • fax: 321-638-1439 • e-mail: [subrato@fsec.ucf.edu](mailto:subrato@fsec.ucf.edu) • [www.baihp.org](http://www.baihp.org)

### National Association of Home Builders (NAHB) Research Center

Tom Kenney • National Association of Home Builders (NAHB) Research Center • 400 Prince George's Boulevard • Upper Marlboro, MD 20774 • 301-430-6246 • fax: 301-430-6180 • toll-free: 800-638-8556 • [www.nahbrc.org/](http://www.nahbrc.org/)

### National Renewable Energy Laboratory

Ren Anderson • 1617 Cole Boulevard, MS-2722 • Golden, CO 80401 • 303-384-7433 • fax: 303-384-7540 • e-mail: [ren\\_anderson@nrel.gov](mailto:ren_anderson@nrel.gov) • [www.nrel.gov](http://www.nrel.gov)

Tim Merrigan • 1617 Cole Boulevard, MS-2722 • Golden, CO 80401 • 303-384-7349 • fax: 303-384-7540 • e-mail: [tim\\_merrigan@nrel.gov](mailto:tim_merrigan@nrel.gov) • [www.nrel.gov](http://www.nrel.gov)

### Oak Ridge National Laboratory

Pat M. Love • P.O. Box 2008 • One Bethel Valley Road • Oak Ridge, TN 37831 • 865-574-4346 • fax: 865-574-9331 • e-mail: [lovepm@ornl.gov](mailto:lovepm@ornl.gov) • [www.ornl.gov](http://www.ornl.gov)

### Pacific Northwest National Laboratory

Michael Baechler • 620 SW 5th, Suite 810 • Portland, OR 97204 • 503-417-7553 • fax: 503-417-2175 • e-mail: [michael.baechler@pnl.gov](mailto:michael.baechler@pnl.gov) • [www.pnl.gov](http://www.pnl.gov)

Produced for the U.S. Department of Energy (DOE) by the National Renewable Energy Laboratory, a DOE national laboratory.

October 2006 • NREL/TP-550-38449

Printed with a renewable-source ink on paper containing at least 50% wastepaper, including 20% postconsumer waste.

Bringing you a prosperous future where energy is clean, abundant, reliable, and affordable